



Marine Products and Systems





*Dedicated to the Memory
of our Teacher, Mentor and
Friend, Bill Wolfe*

Quick Reference

Abrasives 1

Surface Preparation and Conditioning 35

Fillers and Putties 53

Marine Surface Maintenance 57

Finishing 61

Cleaning 68

Tapes and Masking 73

Masking and Welding 90

Adhesives, Sealants and Fasteners 93

Lubricants 104

Paint and Varnish Removal 105

Safety 106

Electrical 135

Miscellaneous 144

Table of Contents

Abrasives

3M Marine Preferred Abrasives Chart	1
3M Marine Abrasive Applications Chart	1
3M™ Stikit™ “Preferred” Abrasives	2–3
3M™ Stikit™ “Better” Abrasives	4–5
3M™ Stikit™ “Good” Abrasives	6
3M™ Stikit™ Abrasive Disc Back-Up Pads	6–7
3M™ Stikit™ Abrasive Hand Pads and Accessories	7
3M™ Hookit™ Conversion Face Pads	8
3M™ Hookit™ “Preferred” Abrasives	8–10
3M™ Hookit™ “Better” Abrasives	10
3M™ Hookit™ Abrasive Disc Back-Up Pads	11
3M™ Hookit™ Abrasive Hand Pads and Accessories	12
3M™ Hookit™ Conversion Face Pads	12
3M™ Stikit™ “Preferred” Abrasive Sheets and Sheet Rolls	13
3M™ Stikit™ “Better” Abrasives	14
3M™ Stikit™ Abrasive Sheet and Sheet Roll Accessories	15
3M™ Hookit™ “Preferred” Abrasive Sheets and Sheet Rolls	16
3M™ Hookit™ Abrasive Sheet and Sheet Roll Accessories	17
3M™ Floor Surfacing Abrasive Rolls	18
3M™ Wetordry™ Sandpaper Sheets	19
3M™ Wetordry™ Accessories	20
9" x 11" Sheet Accessories	21
3M™ Sanding Sponges	22
Cloth Utility Rolls	22
Miscellaneous Abrasive Racks and Accessories	23

3M Woodworking Belt Selection Guide	24
3M™ Stikit™ Dust-Free Abrasives	25–26
3M™ Stikit™ Dust-Free Abrasive Disc Back-Up Pads	27
3M™ Hookit™ “Preferred” Dust-Free Abrasives	28–29
3M™ Hookit™ Dust-Free Abrasive Disc Back-Up Pads	30
Retail Packaged Abrasive Products	31–34

Surface Preparation and Conditioning

Grinding Discs and Wheels	35
3M Grinding Discs	36–37
3M™ Roloc™ Grinding Discs	38
3M Grinding Disc Accessories	39
3M™ Cut-Off and Weld Grinding Wheels	40
3M Depressed Center Grinding Wheels	41
3M™ Green Corps™ Flexible Grinding Wheel Attachment System	42
Scotch-Brite™ Applications Chart	43–44
Scotch-Brite™ Hand Pads	45–46
Scotch-Brite™ Surface Conditioning Discs	46–49
Scotch-Brite™ Cleaning and Striping Products	50
Stripe Removal Discs	51
3M™ Bristle Discs and Brushes	51–52

Fillers and Putties

3M Fillers and Putties	53
3M Vinyl Ester Fiberglass Repair Fillers	53
3M Polyester Fiberglass Repair Fillers	54
3M Fiberglass Repair Putties	55

Table of Contents

Marine Surface Maintenance

3M Hardeners, Resin and Accessories	56
3M Marine “Preferred” Product Systems for Marine Applications	57
3M Marine Surface Maintenance Products – Restoring Products	58
3M Marine Surface Maintenance Products – Cleaning Products	59
3M Marine Surface Maintenance Products – Protecting Products	60

Finishing

3M Marine “Preferred” Finishing	61
3M Marine Gelcoat Finishing Compounds and Glazes	62
3M Buff Pad Accessories	63, 67
3M Marine Paint Finishing Compounds and Glazes	64
Buffing Pad Characteristics Chart	65
3M Compounding Pads	65–66
3M Polishing Pads	66

Cleaning

Cleaning Products	68–71
Sponges, Scrubs and Cloths	71–72

Tapes and Masking

3M Masking Tapes	73–74
3M Paint Striping Tapes	75
3M Weather Resistant Tapes	76
Safe Release Tapes	77
General Purpose Tapes	77
3M Duct Tapes	78
Protective Tapes Long Term	79

Protective Tapes Short Term	79
Thinsulate™ Sound and Thermal Insulation Chart	80
Marking Tapes	81
Filament Strapping Tape and Dispensers	82
Box Sealing Tapes and Dispensers	83–84
Adhesive Transfer Tapes	84
Pipe Thread Sealant Tape	85
Foam and Paper Tapes	85–86
3M Marine “Preferred” Masking Film and Papers	87
3M Masking Paper	87–88
3M Masking Film	89–90

Masking and Welding

Maskers	90–91
Masking Machines	91–92
Welding Drape	92

Adhesives, Sealants and Fasteners

3M Adhesives and Sealants	93
3M Marine Products	94
Adhesives/Sealants	95–96
3M Adhesive Sealant Accessories	96
Adhesives	97
Aerosol Adhesives	98–99
Bulk Adhesives	100
3M™ Command™ Adhesives	101
Fastening Systems	102–103

Lubricants

Lubricants	104
----------------------	-----

Table of Contents

Paint and Varnish Removal

Paint and Varnish Remover and Accessories	105
--	-----

Safety

3M Respirator Selection Guide	106–107
Grinding and Sanding Applications	108
Belt-Mounted PAPR Systems for Grinding and Sanding	109
Welding Applications	110
Belt-Mounted PAPR Systems for Welding	111
3M™ Speedglas™ Products	112–113
Paint Spray Applications	114
A Complete Family of Dual Cartridge Respirators for Grinding, Sanding, Welding and Paint Spray Applications	115
GVP Powered Air Purifying Respirators (PAPRs) for Paint Spray Applications	116
Supplied Air Respirator Systems Using H-Series Hoods	117
Supplied Air Respirator Systems Using L-Series Headgear	118
Dual Airline Supplied Air Respirator Systems Using 3M Facepieces	119
Sorbent Products	120

Head and Face Protection Products	121
Protective Eyewear	122
Hearing Protection Products	123
Important Warnings	124
Personal Care Products	125
Comfort Masks	126
Retail Packaged Safety Products	126–128
Floor and Deck Matting	129–131
Floor and Deck Matting Accessories	132
3M™ Scotchlite™ and Diamond Grade Reflective Products	133–134
3M™ Vanguard™ Lenses	134

Electrical

Electrical Products	135–142
Retail Packaged Electrical Products	143

Miscellaneous

3M™ Scotchpad™ Hang Tabs	144
Post-it® Quality Flag	144
Laminating Systems	145
Point of Sale Displays	145

Abrasives

3M Marine Preferred Abrasives

Application	"Best"		"Good"	
Surface Removal	3M™ Green Corps™ Grinding Discs		3M™ Type D Grinding Discs	
	3M™ Imperial™ Hookit™ or Stikit™ Abrasives		3M™ Green Corps™ Stikit™ Abrasives	
Fairing or Blending	3M™ Imperial™ Hookit™ or Stikit™ Abrasives		3M™ Gold 216U Stikit™ Abrasives	
Surface Conditioning	3M™ Imperial™ Hookit™ or Stikit™ Abrasives		3M™ Gold 216U Stikit™ Abrasives 3M™ Wetordry™ Sheets	

3M Marine Abrasive Applications

	Professional Repair/Aftermarket							
	Bottom Paint Removal	Bottom Paint Prep and Scuffing	Epoxy Sanding / Fiberglass Repair	Fairing	Paint Prep / Primer Sanding	Gelcoat Finishing	Paint Finishing	Brightwork / Wood
3M™ Stikit™ Abrasives								
3M™ Imperial™ Stikit™ Abrasive Disc Rolls	P	P	P	P	P	P	P	P
3M™ Imperial™ Stikit™ Abrasive Disc Rolls 360L				B		B		
3M™ Stikit™ Finishing Film Discs 260L						P	P	
3M™ Stikit™ Gold Abrasive Disc Rolls 216U		B	B	B	B	B	B	B
3M™ Stikit™ Gold Abrasive Disc Rolls 236U		B	B	B	B	B	B	B
3M™ Imperial™ Stikit™ Abrasive Disc Rolls 363I	B	B	B	B				B
3M™ Stikit™ Green Corps™ Abrasive Discs	B	B	B					B
3M™ Stikit™ Tri-M-Ite™ Abrasive Disc Rolls 414N								G
3M™ Hookit™ Abrasives								
3M™ Imperial™ Hookit™ Abrasive Discs	P	P	P	P	P	P	P	P
3M™ Imperial™ Hookit™ Abrasive Discs 360L				B		B		
3M™ Imperial™ Hookit™ Finishing Film Discs 260L						P	P	
3M™ Hookit™ Green Corps™ Abrasive Discs	B	B	B					B

	Boat Building			
	Plugs	Mold Repair	Patch and Repair	Final Finish
3M™ Stikit™ Abrasives				
3M™ Imperial™ Stikit™ Abrasive Disc Rolls		P	P	P
3M™ Imperial™ Stikit™ Abrasive Disc Rolls 360L	P		P	P
3M™ Stikit™ Finishing Film Discs 260L				
3M™ Stikit™ Gold Abrasive Disc Rolls 216U				
3M™ Stikit™ Gold Abrasive Disc Rolls 236U				
3M™ Imperial™ Stikit™ Abrasive Disc Rolls 363I				
3M™ Stikit™ Green Corps™ Abrasive Discs				
3M™ Stikit™ Tri-M-Ite™ Abrasive Disc Rolls 414N				
3M™ Hookit™ Abrasives				
3M™ Imperial™ Hookit™ Abrasive Discs		P	P	P
3M™ Imperial™ Hookit™ Abrasive Discs 360L	P		P	P
3M™ Imperial™ Hookit™ Finishing Film Discs 260L				
3M™ Hookit™ Green Corps™ Abrasive Discs				

P = Preferred Abrasive
B = Better Abrasive
G = Good Abrasive

3M™ Stikit™ “Preferred” Abrasives

3M™ Stikit™ Abrasives are pressure-sensitive adhesive backed for easy application and removal. Use with 3M Stikit abrasive back-up pads.

3M™ Imperial™ Stikit™ Abrasives

3M's “Preferred” abrasive. Purple in color, which designates 3M's latest technology, greatest cost/value and highest quality abrasive. 3M Imperial Abrasives have several quality construction advantages which provide increased benefit and cost/value. P80 – P500 have a higher quality C-weight paper backing, and come in convenient disc rolls. Grits P36E – P80E have a higher quality E-weight paper backing. They are boxed, individually lined discs. Both are designed to provide more durability, better cut and longer life. All grits are constructed of a high quality aluminum oxide mineral, with grits P36E – P180 having a unique blended mineral designed to cut faster and last longer. Excellent for use on tough marine gelcoat, paint and primer systems. Also outstanding on wood.



3M™ Imperial™ Stikit™/Disc Rolls 334U and 734U

Part Number	Product ID	Grade	Discs/ Roll	Rolls/ Case
5"				
051131-00298	734U	P500	75	4
051131-00299	734U	P400	75	4
051131-00301	734U	P320	75	4
051131-00302	734U	P280	75	4
051131-00303	734U	P240	75	4
051131-00304	745I	P220	75	4
051131-00305	734U	P180	75	4
051131-00306	734U	P150	75	4
051131-00307	734U	P120	75	4
051131-00308	734U	P100	75	4
051131-00309	734U	P80	75	4
6"				
051131-00322	334U	P500	75	4
051131-00323	334U	P400	75	4
051131-00324	334U	P360	75	4
051131-00325	334U	P320	75	4
051131-00326	334U	P280	75	4
051131-00327	334U	P240	75	4
051131-00328	334U	P220	75	4
051131-00329	734U	P180	75	4
051131-00330	734U	P150	75	4
051131-00331	734U	P120	75	4
051131-00332	734U	P100	75	4
051131-00333	734U	P80	75	4
8"				
051131-00337	334U	P320	100	4
051131-00338	334U	P220	100	4
051131-00339	734U	P180	100	4
051131-00340	734U	P120	100	4
051131-00341	734U	P80	100	4

3M™ Imperial™ Stikit™ Disc Rolls 745I and 740I

Part Number	Product ID	Grade	Discs/ Box	Box/ Case
5"				
051131-00336	745I	P80E	50	4
051131-00381	740I	60E	50	4
051131-00367	740I	40E	50	4
051131-00368	740I	36E	50	4
6"				
051131-00371	745I	P80E	100	4
051131-00372	740I	60E	50	4
051131-00373	740I	40E	50	4
051131-00374	740I	36E	50	4
8"				
051131-00377	745I	P80E	25	4
051131-00378	740I	60E	25	4
051131-00379	740I	40E	25	4
051131-00380	740I	36E	25	4

3M™ Imperial™ Stikit™ Abrasive Disc Rolls 360L

High quality abrasive discs designed to cut faster and last longer on composite substrates, enabling the user to obtain maximum usage from each disc. Designed for use on gelcoat. Not recommended for sanding coatings, as this abrasive contains no 3M™ Fre-Cut™ to prevent loading. Convenient disc rolls.



Part Number	Grade	Sheets/Roll	Rolls/Case
5"			
051135-06223	P1000	125	4
051135-06222	P800	125	4
051135-06221	P600	125	4
051135-06220	P500	125	4
051135-06219	P400	125	4
051135-06218	P360	125	4
051135-06217	P320	125	4
051135-06216	P280	125	4
051135-06214	P240	125	4
051135-06213	P220	125	4
6"			
051135-14002	P1000	125	4
051135-14003	P800	125	4
051135-14004	P600	125	4
051135-14005	P500	125	4
051135-14006	P400	125	4
051135-14007	P360	125	4
051135-14008	P320	125	4
051135-14009	P280	125	4
051135-14010	P240	125	4
051135-14011	P220	125	4

3M™ Stikit™ “Preferred” Abrasives

3M™ Stikit™ Finishing Film Discs 260L

Designed for use in scuff sanding before painting, as well as to remove runs, dust nibs, and excess orange peel from paint and gelcoat prior to compounding. These discs allow for machine sanding versus having to hand sand prior to compounding or using very aggressive compounds (multiple applications of). These 3M™ Stikit™ discs are individually lined and constructed of a high-performance, aluminum oxide mineral bonded to a smooth film pressure-sensitive adhesive backing. Cuts fast, lasts long, resists loading and leaves a consistent finish.



Part Number	Product I.D.	Grade	Discs/ Box	Boxes/ Case
5"				
051144- 83681	260L	P1200	100	4
051144- 83680	260L	P1000	100	4
051144- 83679	260L	P800	100	4
051144- 83678	260L	P600	100	4
6"				
051131- 01318	260L	P1200	100	4
051131- 01319	260L	P1000	100	4
051131- 01320	260L	P800	100	4
051131- 01321	260L	P600	100	4

3M™ Green Corps™ Stikit™ Production™ Resin Bond Discs 225U, 251U and 246U

3M's "Better" abrasives have a durable mineral/bond construction and tough D-weight or E-weight paper backing that is fast-cutting and long-lasting. 246U discs have 3M™ Fre-Cut,™ which is a special treatment to resist loading. These discs are excellent for coarse sanding of hull and deck areas, paint removal, scuffing between bottom paint coats and fairing. Grade 24E is designed for heavy bottom paint and gelcoat removal. 246U come in a convenient disc roll, while 255U and 251U discs are individually lined.

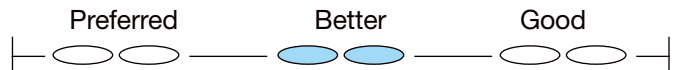

Part Number	Product ID	Grade	Rolls or Packs/ Discs	Rolls or Packs/ Case
5"				
051144- 01501	246U	80D	100/Bulk	10
051131- 01545	251U	40E	100/Bulk	5
051131- 01546	251U	36E	100/Bulk	5
6"				
051144- 01506	246U	80D	100/Bulk	10
051131- 01547	251U	40E	100/Bulk	5
051131- 01548	251U	36E	100/Bulk	5
051131- 01549	246U	80D	50/Bulk	5
8"				
051131- 01550	251U	40E	50/Bulk	5
051131- 01551	251U	36E	50/Bulk	5
051131- 01552	255U	24E	20	5
051131- 01556	255U	60E	50	5

3M™ Stikit™ “Better” Abrasives

3M's “Better” abrasives have a tough, durable aluminum oxide mineral. They are aggressive, sharp, fast cutting and long lasting. Gold disc roll construction also resists dulling, excess edge wear, and these discs have 3M™ Fre-Cut™, which is a special treatment designed to prevent loading. 3M™ Stikit™ Gold Abrasive Disc Rolls 216U have a lighter A-weight paper backing. 3M Stikit gold abrasive disc rolls 236U have a heavier C-weight paper backing for excellent support, and these discs have clear, non-staining 3M Fre-Cut. They can be conveniently dispensed using the 3M Stikit disc roll dispenser (PN05450).

3M™ Stikit™ Gold Abrasive Disc Rolls 216U A-weight

3M's “Better” abrasives is tough, durable aluminum oxide mineral, aggressive, sharp, fast-cutting and long-lasting. Resists dulling and excess wear. 3M™ Fre-Cut™ to prevent loading; 236U has a clear, non-staining 3M Fre-Cut. A-weight and C-weight paper backing. Use with 3M™ Stikit™ Abrasive back-up pads.

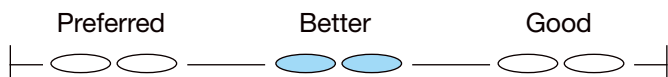

3M™ Stikit™ Gold Abrasive Disc Rolls 216U A-weight

Part Number	Product ID	Grade	Discs/ Roll	Rolls/ Case
5"				
051131-01215	216U	P800A	100	4
051131-01214	216U	P600A	100	4
051131-01417	216U	P500A	175	6
051131-01419	216U	P400A	175	6
051131-01418	216U	P360A	175	6
051144-01420	216U	P320A	175	6
051144-01421	216U	P280A	175	6
051144-01422	216U	P240A	175	6
051144-01423	216U	P220A	175	6
051144-01424	236U	P180A	175	6
051144-01425	236U	P150A	175	6
051144-01426	236U	P120A	125	10
051144-01427	236U	P100A	125	10
051144-01428	236U	P80A	125	10
6"				
051131-01202	216U	P500A	75	6
051131-01203	216U	P400A	75	6
051131-01204	216U	P360A	75	6
051131-01205	216U	P320A	75	12
051131-01206	216U	P280A	75	6
051131-01208	216U	P220A	75	12
051131-01216	216U	P600A	125	4
051131-01432	216U	P500A	125	4
051131-01434	216U	P400A	175	6
051131-01433	216U	P360A	175	6
051144-01435	216U	P320A	175	6

3M™ Stikit™ Gold Abrasive Disc Rolls 216U A-weight (cont.)

Part Number	Product ID	Grade	Discs/ Roll	Rolls/ Case
6" continued				
051144-01436	216U	P280A	175	6
051144-01437	216U	P240A	175	6
051144-01438	216U	P220A	175	6
051144-01439	236U	P180A	175	6
051144-01440	236U	P150A	175	6
051144-01441	236U	P120A	175	10
051144-01442	236U	P100A	125	10
051144-01443	236U	P80A	125	10
8"				
051131-01484	216U	P400A	125	4
051131-01485	216U	P320A	125	4
051131-01487	216U	P240A	125	4
051131-01488	216U	P220A	125	4
051131-01489	216U	P180A	125	4
051131-01490	216U	P150A	125	4
051131-01491	216U	P120A	125	4
051131-01492	216U	P100A	125	4
051131-01493	216U	P80A	125	4

3M™ Stikit™ Gold Abrasive Disc Rolls 236U C-weight, (Non-Staining 3M™ Fre-Cut™)

A strong “C” weight backing provides excellent support for a tough and durable aluminum oxide mineral. These discs are aggressive, sharp, fast cutting and long lasting. The non-staining 3M™ Fre-Cut™ resists loading and the pressure-sensitive adhesive ensures excellent adhesion to 3M™ Stikit™ pads. Excellent for gelcoat, wood and plastic applications.



Part Number	Product ID	Grade	Discs/ Roll	Rolls/ Case
5"				
051144-86497	236U	P500C	100	4
051144-86496	236U	P400C	100	4
051144-86495	236U	P320C	100	4
051144-86493	236U	P240C	100	4
051144-86492	236U	P320C	100	4
051144-86491	236U	P150C	100	4
051144-86490	236U	P120C	100	4
051144-86489	236U	P100C	100	4
051144-86488	236U	P80C	100	4
6"				
051144-86477	236U	P500C	100	4
051144-86476	236U	P400C	100	4
051144-86475	236U	P320C	100	4
051144-86474	236U	P240C	100	4
051144-86473	236U	P220C	100	4
051144-86472	236U	P180C	100	4
051144-86471	236U	P150C	100	4
051144-86470	236U	P120C	100	4
051144-86469	236U	P100C	100	4
051144-86468	236U	P80C	100	4

3M™ Stikit™ “Better” Abrasives

3M™ Stikit™ Imperial™ Gold Abrasive Disc Rolls 363I F-weight



3M's “Better” abrasives have tough and durable aluminum oxide mineral bonded with a full heat resistant resin to a very strong F-weight backing. This construction provides excellent shelling and tear resistance, which increases disc life and performance. Excellent for scratch refinement after coarse sanding.



Part Number	Product ID	Grade	Discs/ Roll	Rolls/ Case
5"				
051144- 21795	363I	180F	100	4
051144- 21796	363I	P150F	100	4
051144- 21797	363I	P120F	100	4
051144- 21798	363I	P100F	100	4
051144- 21799	363I	80F	100	4
051144- 21800	363I	60F	100	4
6"				
051144- 21789	363I	180F	100	4
051144- 21790	363I	P150F	100	4
051144- 21791	363I	P120F	100	4
051144- 21792	363I	P100F	100	4
051144- 21793	363I	80F	100	4
051144- 21794	363I	60F	100	4
8"				
051144- 21783	363I	180F	50	4
051144- 21784	363I	P150F	50	4
051144- 21785	363I	P120F	50	4
051144- 21786	363I	P100F	50	4
051144- 21787	363I	80F	50	4
051144- 21788	363I	80F	50	4

3M™ Stikit™ “Good” Abrasives

3M™ Stikit™ Tri-M-Ite™ Fre-Cut™ Abrasive Disc Rolls 414N

3M's “Good” abrasives have an extremely sharp silicon-carbide mineral with 3M™ Fre-Cut,™ which is a special treatment designed to resist loading.



Part Number	Product ID	Grade	Discs/ Roll	Rolls/ Case
5"				
051144- 11287	414N	400A	250	4
051144- 01450	414N	320A	250	4
051144- 01451	414N	280A	250	4
051144- 01453	414N	220A	250	4
051144- 01454	414N	180A	250	4
051144- 01455	414N	150A	250	4
051144- 01456	414N	120A	125	8
051144- 01458	414N	80A	125	8
6"				
051144- 11289	414N	400A	250	4
051144- 01465	414N	320A	250	4
051144- 01466	414N	280A	250	4
051144- 01467	414N	240A	250	4
051144- 01468	414N	220A	250	4
051144- 01469	414N	180A	250	4
051144- 01470	414N	150A	250	4
051144- 01471	414N	120A	125	8
051144- 01472	414N	100A	125	8
051144- 01473	414N	80A	125	8

3M™ Stikit™ Abrasive Disc Back-Up Pads

3M™ Stikit™ Abrasive Disc Back-Up Pads are specially-made for use with 3M Stikit abrasive discs. Vinyl pad facing provides good adhesion of the discs, yet allows easy disc removal. Disc pads are lightweight, shock resistant and well balanced. See Maximum Safe Operating Speed (MOS) for each pad.

3M™ Stikit™ Disc Pads

For use in most sanding applications.

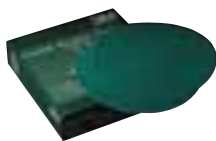

Part Number	For Use with Disc Size	MOS	Pads/ Case
051144- 05575	5"	10,000 RPM	10
051144- 05576	6"	10,000 RPM	10

3M™ Stikit™ Disc Pad – 5/8" Hole

For use on slow speed polishers and grinders. Red face 5" x 3/4" with 5/8" – 11 female thread size.



Part Number	For Use with Disc Size	MOS	Pads/ Case
051144- 82189	5"	10,000 RPM	10

3M™ Stikit™ Low Profile Disc Pads

Designed to assist marine refinishers in sanding under rub rails, roe rails, along chines and rudder posts. The foam construction enhances the operator's “feel” in final fairing and finishing applications.



Part Number	For Use with Disc Size	MOS	Pads/ Case
051131- 05555	5"	12,000 RPM	10
051131- 05556	6"	10,000 RPM	10

3M™ Stikit™ Low Profile Finishing Disc Pads

Soft foam construction for fine finish sanding. Offers outstanding conformability to contours and curves. Use on random orbital sanders only.



Part Number	For Use with Disc Size	MOS	Pads/ Case
051131- 05545	5"	12,000 RPM	10
051131- 05546	6"	10,000 RPM	10

3M™ Stikit™ Abrasive Disc Back-Up Pads

3M™ Stikit™ Disc Pad — 8"

Edges are contoured to allow for sanding curves and close to moldings.



Part Number	For Use with Disc Size	MOS	Pads/Case
051144- 05579	8"	3,000 RPM	1

3M™ Stikit™ Disc Pad — Replacement 8"

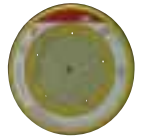

Part Number	Replacement Pad for Model	MOS	Pads/Case
051131- 05581	National-Detroit 900	1,500 RPM	1
051131- 05582	Chicago Pneumatic 777	1,500 RPM	1

3M™ Stikit™ Soft Disc Pad

Specially designed for use with 3M™ Stikit™ Discs. Vinyl pad face provides good adhesion and allows easy removal of the discs. Its soft foam construction and tapered edge offer a high degree of conformability, providing a uniform finish when sanding contours and curves. Fits all standard (5/8" shaft) slow speed polishers.



Part Number	For Use with Disc Size	MOS	Pads/Case
051131- 05568	8"	3,000 RPM	1

3M™ Stikit™ Abrasive Hand Pads and Accessories

3M™ Stikit™ Abrasive Disc Hand Pads

3M™ Stikit™ Abrasive Disc Hand Pads are a unique method of sanding fiberglass, gelcoat, metal and wood by utilizing 3M Stikit abrasive discs. They eliminate finger marks and have excellent conformability when used in curves and contours. These pads are designed to securely hold the disc, yet allow for easy removal. They come in three levels of thickness and a molded version.



Part Number	Size	Pads/Inner	Pads/Case
051144- 45188	5" x 1/8"	1	20
051144- 45198	6" x 1/8"	1	20
051144- 45189	5" x 1/4"	1	20
051131- 05591	6" x 1/4"	1	20
051144- 84229	5" x 1"	1	10
051144- 11063	5" x 1"	1	10
051131- 05589	6" x 1"	10	4
051144- 88742	5" Molded	1	10

3M™ Stikit™ Hand Pads

Firm, yet comfortable and lightweight, making sanding of such areas as next to chrome and trim, corners, curves and contours easier.



Part Number	For Use with Disc Size	Each/Case
051144- 05585	5"	10
051144- 05586	6"	10

3M™ Stikit™ Disc Roll Dispensers

These sturdy metal dispensers provide a convenient means of storage and single disc dispensing of 3M™ Stikit™ Disc Rolls. Dispenser can be wall or bench mounted as well as used portable. Holds two 125 count disc rolls. **NOTE: PRODUCTS DO NOT COME WITH THIS DISPENSER.**



Part Number	Description	Each/Case
051144- 05450	5" or 6" Diameter 1" Core	10

3M™ Hookit™ Conversion Face Pads

3M™ Hookit™ II Abrasive Disc Conversion Face Pad

This accessory can be used where the existing disc pad is designed for 3M™ Hookit™ II Abrasive Discs and the user instead wants to use it is 3M™ Stikit™ Abrasive Discs.

Part Number	Size	MOS	Pads/ Case
051111- 51072	5" No Hole	12,000 RPM	10
051111- 51071	6" No Hole	12,000 RPM	10

3M™ Hookit™ “Preferred” Abrasives

3M™ Hookit™ Abrasives incorporate a convenience hook-and-loop attachment system for easy attachment and removal. These discs allow for reattachment and reuse, thus making them more economical. Use with 3M Hookit abrasive back-up pads.

3M™ Imperial™ Hookit™ Abrasives

3M's preferred abrasives designed to work with 11-inch sanders. Available in both no-hole formats and O Style, which has a 5-inch center hole. The new 11-inch discs work well in plug shops, gelcoat repair and other large fairing process areas in yacht builders, boat builders and repair yards. The 11-inch discs with the tool can help to increase productivity with their full 99 square inches of abrasives surface area.



3M™ Imperial™ Hookit™ Discs 334U, 734U, 740I and 745I

Part Number	Product ID	Grade	Discs/ Box	Box/ Case
3"				
051131- 01783	734U	P180	50	4
051131- 01784	734U	P150	50	4
051131- 01785	734U	P120	50	4
051131- 01786	734U	P100	50	4
051131- 01787	734U	P80	50	4

Part Number	Product ID	Grade	Discs/ Box	Box/ Case
5"				
051131- 01756	334U	P500	50	4
051131- 01757	334U	P400	50	4
051131- 01759	334U	P320	50	4
051131- 01760	334U	P280	50	4
051131- 01761	334U	P240	50	4
051131- 01762	334U	P220	50	4
051131- 01763	734U	P180	50	4
051131- 01764	734U	P150	50	4
051131- 01765	734U	P120	50	4
051131- 01766	734U	P100	50	4
051131- 01767	734U	P80	50	4
051131- 01728	745I	P80E	25	4
051131- 01770	740I	60E	25	4
051131- 01729	740I	40E	25	4
051131- 01730	740I	36E	25	4
051131- 01774	334U	P320	50	4
051131- 01775	334U	P280	50	4
051131- 01776	334U	P240	50	4
051131- 01777	334U	P220	50	4
051131- 01778	734U	P180	50	4
051131- 01779	734U	P150	50	4
051131- 01780	734U	P120	50	4
051131- 01781	734U	P100	50	4
051131- 01782	734U	P80	50	4
051131- 01733	745I	P80E	25	4
051131- 01773	740I	60E	25	4
051131- 01734	740I	40E	25	4
051131- 01735	740I	36E	25	4
8"				
051131- 01838	334U	P320	25	4
051131- 01839	334U	P220	25	4
051131- 01840	734U	P180	25	4
051131- 01841	734U	P150	25	4
051131- 01842	734U	P120	25	4
051131- 01843	734U	P80	25	4
051131- 01743	745I	P80E	25	4
051131- 01768	740I	60E	25	4
051131- 01744	740I	40E	25	4
051131- 01745	740I	36E	25	4

3M™ Hookit™ “Preferred” Abrasives

3M™ Imperial™ Hookit™ Abrasives – 11-1/4"

3M's "Preferred" abrasive is designed to work with 11-inch sanders. Available in both no-hole formats and O Style, which has a 5-inch center hole. The new 11-inch discs work well in plug shops, gelcoat repair and other large fairing process areas in yacht builders, boat builders and repair yards. The 11-inch discs with the tool can help to increase productivity with their full 99 sq. in. of abrasives surface area.



3M™ Imperial™ Hookit™ Abrasives 334U, 734U, 740I and 745I

Part Number	Product ID	Grade	Discs/Box	Box/Case
11-1/4" No Hole				
NEW 051131-01886	740I	36E	25	4
NEW 051131-01887	740I	40E	25	4
NEW 051131-01888	740I	60E	25	4
NEW 051131-01889	745I	80E	25	4
NEW 051131-01905	334U	P320	25	4
NEW 051131-01906	334U	P280	25	4
NEW 051131-01904	334U	P220	25	4
NEW 051131-01903	734U	P180	25	4
NEW 051131-01902	734U	P150	25	4
NEW 051131-01901	734U	P120	25	4
NEW 051131-01900	734U	P100	25	4
11-1/4" O Style				
NEW 051131-01896	740I	36E	25	4
NEW 051131-01897	740I	40E	25	4
NEW 051131-01898	740I	60E	25	4
NEW 051131-01899	745I	80E	25	4
NEW 051131-01962	734U	C80	25	4
NEW 051131-01963	734U	C120	25	4
NEW 051131-01964	734U	C150	25	4
NEW 051131-01965	734U	C180	25	4
NEW 051131-01966	334U	C220	25	4
NEW 051131-01967	334U	C320	25	4
NEW 051131-01968	334U	C280	25	4

3M™ Imperial™ Hookit™ Abrasives 360L

High quality abrasive discs designed to cut faster and last longer on composite substrates, enabling the user to obtain maximum usage from each disc. Designed for use on gelcoat. Discs come conveniently boxed. Not recommended for sanding coatings, as this abrasive contains no 3M™ Fre-Cut™ to prevent loading.



Part Number	Product ID	Grade	Discs/Box	Box/Case
3"				
051115-19621	360L	P1000	50	4
051115-19622	360L	P800	50	4
051115-19623	360L	P600	50	4
051115-19624	360L	P500	50	4
051115-19625	360L	P400	50	4
051115-19626	360L	P320	50	4
051115-19627	360L	P240	50	4
051115-19628	360L	P220	50	4
5"				
051111-55723	360L	P1000	100	5
051111-55722	360L	P800	100	5
051111-55721	360L	P600	100	5
051111-55720	360L	P500	100	5
051111-55719	360L	P400	100	5
051111-55718	360L	P360	100	5
051111-55717	360L	P320	100	5
051111-55716	360L	P280	100	5
051111-55714	360L	P240	100	5
051111-55713	360L	P220	100	5
6"				
051135-13935	360L	P1000	100	5
051135-13936	360L	P800	100	5
051135-13937	360L	P600	100	5
051135-13938	360L	P500	100	5
051135-13939	360L	P400	100	5
051135-13940	360L	P360	100	5
051135-13941	360L	P320	100	5
051135-13942	360L	P280	100	5
051135-13943	360L	P240	100	5
051135-13944	360L	P220	100	5

3M™ Hookit™ “Preferred” Abrasives

3M™ Hookit™ Finishing Film Discs 260L

3M™ Hookit™ Finishing Film Discs 260L are designed for use in scuff sanding before painting, as well as to remove runs, dust nibs, and excess orange peel from paint and gelcoat prior to compounding. These discs allow for machine sanding versus having to hand sand prior to compounding or using very aggressive compounds (multiple applications of). These discs are constructed of a high-performance, aluminum oxide mineral bonding to a smooth film backing. Cuts fast, lasts long, resists loading and leaves a consistent finish.



Part Number	Product ID	Grade	Discs/Box	Boxes/Case
3"				
051131- 00907	260L	P1500	50	4
051131- 00908	260L	P1200	50	4
051131- 00909	260L	P1000	50	4
051131- 00910	260L	P800	50	4
051131- 00911	260L	P600	50	4
5"				
051131- 00951	260L	P1500	100	4
051131- 00952	260L	P1200	100	4
051131- 00953	260L	P1000	100	4
051131- 00954	260L	P800	100	4
051131- 00955	260L	P600	100	4
6"				
051131- 00950	260L	P1500	100	4
051131- 00968	260L	P1200	100	4
051131- 00969	260L	P1000	100	4
051131- 00970	260L	P800	100	4
051131- 00971	260L	P600	100	4

3M™ Hookit™ “Better” Abrasives

3M™ Green Corps™ Hookit™ Abrasives

3M's “Better” abrasive is designed for heavy bottom paint and gelcoat removal, as well as for paint removal and sanding marine fairing compounds and fiberglass. Best used with 3M™ Hookit™ 8" Soft Disc Pad (PN05768), as it is designed to conform to the curves and contours found on boat hulls and decks.



Part Number	Product ID	Grade	Discs/Box	Boxes/Case
051131- 01652	225U	24E	20	5

3M™ Trizact™ Hookit™ II Foam Discs

3M™ Trizact™ abrasive features a pyramid-shaped structure that contains multiple layers of abrasive mineral. Provides a consistently smooth finish. Use to refine Finishing Film scratches. 3M™ Hookit™ II attachment system: The stems, or hooks, are on the back of the abrasive and the loops are on the front of the accessory.



Part Number	Size	Discs/Box	Boxes/Case
051131- 02077	3"	15	4
051131- 02075	6"	15	4

3M™ Hookit™ Abrasive Disc Back-Up Pads

3M™ Hookit™ Abrasive Disc Back-Up Pads are specially-made for use with 3M Hookit abrasive discs. The pad face securely holds the discs, yet allows easy change and reattachment of the disc. Disc pads have conformable foam body with a durable plastic hub and are lightweight, shock resistant and well balanced. See Maximum Safe Operating Speed (MOS) for each pad.

3M™ Hookit™ Disc Pads

For use in most sanding applications.



Part Number	For Use with Disc Size	MOS	Pads/Case
051131-05769*	3"	12,000 RPM	5
051131-05775	5"	12,000 RPM	10
051131-05776	6"	12,000 RPM	10

*For use on Snap-On AT-402 Sander.

3M™ Hookit™ Low Profile Disc Pads

Designed to assist marine refinishers in sanding under rub rails, roe rails, along chines and rudder posts. The foam construction enhances the operator's "feel" in final fairing and finishing applications.



Part Number	For Use with Disc Size	MOS	Pads/Case
051131-05755	5"	12,000 RPM	10
051131-05756	6"	12,000 RPM	10

3M™ Hookit™ Low Profile Finishing Disc Pads

Soft foam construction for fine finish sanding. Offers outstanding conformability to contours and curves. Use on random orbital sanders only.



Part Number	For Use with Disc Size	MOS	Pads/Case
051144-77855	5"	12,000 RPM	10

3M™ Hookit™ Soft Interface Disc Pads

These soft interface pads are a very flexible foam which attach to a standard 3M™ Hookit™ disc pad to provide excellent full disc contact, even on curved surfaces.



Part Number	For Use with Disc Size	Pads/Case
051131-05771	3"	10
051131-05773	5"	10
051131-05774	6"	10

3M™ Hookit™ Disc Pad – 8"

Edges are contoured to allow for sanding curves and close to moldings.



Part Number	For Use with Disc Size	MOS	Pads/Case
051131-05779	8"	3,000 RPM	10

3M™ Hookit™ Soft Disc Pad – 8"

Soft foam construction and tapered edge offer conformability and a consistent, uniform finish when sanding contours and curves.



Part Number	For Use with Disc Size	MOS	Pads/Case
051131-05768	8"	3,000 RPM	1
051144-14738	5"	7,000 RPM	1

3M™ Hookit™ Disc Pad – Replacement 8"



Part Number	Description	MOS	Pads/Case
051131-05781	National-Detroit 900	1,500 RPM	1
051131-05782	Chicago Pneumatic 777	1,500 RPM	1

3M™ Hookit™ Abrasive Hand Pads and Accessories

3M™ Hookit™ Abrasive Disc Hand Pads

A unique method of sanding fiberglass, gelcoat, metal and wood by utilizing 3M™ Hookit™ Abrasive Discs. They eliminate finger marks and have excellent conformability when used in curves and contours. These pads are designed to securely hold the disc, yet allow for easy removal and reattachment.



Part Number	Size	Pad/Inner	Pads/Case
051144- 55736	3" x 1/4"	1	10
051144- 77752	5" x 1/4"	1	20
051144- 77750	5" x 1"	1	10
051144- 85095	5" Molded	1	10
051131- 05791	6" x 1/4"	1	20

3M™ Hookit™ Half-Round Pad

This is a conformable pad with a straight edge for scuff sanding up to detail lines and molding. 3M™ Hookit™ Discs are applied by lining up with the curved side of the pad folded over the straight edge and attached on the other side.



Part Number	For Use with Disc Size	Pads/Case
051131- 05792	6"	20

3M™ Hookit™ Conversion Face Pads

3M™ Hookit™ II to 3M™ Hookit™ Abrasive Disc Conversion Face Pad

This accessory can be used where the existing disc pad is designed for 3M™ Hookit™ II Abrasive Discs and the user instead wants to use it with 3M Hookit abrasive discs.

Part Number	Size	MOS	Pads/Case
051111- 51074	5" No Hole	12,000 RPM	10
051144- 51073	6" No Hole	12,000 RPM	10

3M™ Stikit™ “Preferred” Abrasive Sheets and Sheet Rolls

3M™ Stikit™ Abrasives are pressure-sensitive adhesive backed for easy application and removal. Use with 3M Stikit Abrasive file boards, blocks, pads and shoes.

3M™ Imperial™ Stikit™ Abrasive Sheets and Rolls



3M's “Preferred” abrasive. Purple in color, which designates 3M's latest technology, greatest cost/value and highest quality abrasive. 3M™ Imperial™ Abrasives have several quality construction advantages which provide increased benefit and cost/value. P80 – P500 have a higher quality C-weight paper backing. Grits P36E – P80E have a higher quality E-weight paper backing. Both are designed to provide more durability, better cut and longer life. All grits are constructed of a high quality aluminum oxide mineral, with grits P36E – P180 having a unique blended mineral designed to cut faster and last longer. Excellent for use on tough marine gelcoat, paint and primer systems. Also outstanding on wood. Sheets come individually lined in boxes. Rolls are lined and individually boxed in their own convenient dispenser.



3M™ Imperial™ Stikit™ Sheets and Rolls 334U, 734U, 740I and 745I

Part Number	Product ID	Grade	Sheets/ Box	Box/ Case
2-3/4" x 16-1/2"				
051131-00389	745I	P120E	50	4
051131-00390	745I	P100E	50	4
051131-00391	745I	P80E	50	4
051131-00392	740I	60E	50	4
051131-00393	740I	40E	50	4
051131-00394	740I	36E	50	4

3M™ Imperial™ Stikit™ Sheets and Rolls 334U, 734U, 740I and 745I (cont.)

Part Number	Product ID	Grade	Length	Rolls/ Case
2-3/4"				
NEW 051131-00382	334U	P220	45 yds.	6
NEW 051131-00429	734U	P180	45 yds.	6
NEW 051131-00430	734U	P150	30 yds.	6
NEW 051131-00431	734U	P120	30 yds.	6
NEW 051131-00432	734U	P100	30 yds.	6
NEW 051131-00433	734U	P80	30 yds.	6
NEW 051131-00434	740I	P80E	20 yds.	6
NEW 051131-00435	740I	P60E	20 yds.	6
NEW 051131-00436	740I	P40E	20 yds.	6
NEW 051131-00437	740I	P36E	20 yds.	6
NEW 051131-00350	334U	P320	45 yds.	6
NEW 051131-00351	334U	P240	45 yds.	6
4-1/2"				
NEW 051131-00484	334U	P320	45 yds.	6
NEW 051131-00485	334U	P240	45 yds.	6
NEW 051131-00486	334U	P220	45 yds.	6
NEW 051131-00487	734U	P180	45 yds.	6
NEW 051131-00488	734U	P150	30 yds.	6
NEW 051131-00489	734U	P120	30 yds.	6
NEW 051131-00496	734U	P100	30 yds.	6
NEW 051131-00497	734U	P80	30 yds.	6
NEW 051131-00498	740I	P80E	20 yds.	6
NEW 051131-00499	740I	P60E	20 yds.	6
NEW 051131-00500	740I	P40E	20 yds.	6
NEW 051131-00501	740I	P36E	20 yds.	6

3M™ Stikit™ “Better” Abrasives

3M™ Stikit™ Gold Abrasive Sheet Rolls 216U

3M’s “Better” abrasives have a tough, durable aluminum oxide mineral. They are aggressive, sharp, fast cutting and long lasting. Gold disc roll construction resists dulling, excess edge wear, and these discs have 3M™ Fre-Cut™, which is a special treatment designed to prevent loading. Have a lighter A-weight paper backing, and they come in both 2-3/4" and 4-1/2" widths. 2-3/4" width rolls can be used with 3M™ Stikit™ Double-Roll Dispenser (PN05452) to cut desired lengths for use on file boards, pads, blocks and shoes.

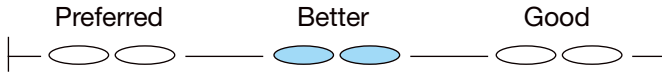

Part Number	Product ID	Grade	Length	Rolls/Case
2-3/4"				
051131- 02589	216U	P500A	45 yds.	10
051131- 02590	216U	P400A	45 yds.	10
051131- 02591	216U	P320A	45 yds.	10
051131- 02593	216U	P240A	45 yds.	10
051131- 02594	216U	P220A	45 yds.	10
051131- 02595	216U	P180A	45 yds.	10
051131- 02586	216U	P150A	45 yds.	10
051131- 02597	216U	P120A	45 yds.	10
051131- 02598	216U	P100A	45 yds.	10
051131- 02599	216U	P80A	45 yds.	10
4-1/2"				
051131- 02689	216U	P400A	45 yds.	6
051131- 02691	216U	P320A	45 yds.	6
051131- 02693	216U	P220A	45 yds.	6
051131- 02694	216U	P180A	45 yds.	6
051131- 02695	216U	P150A	45 yds.	6
051131- 02696	216U	P120A	45 yds.	6
051131- 02697	216U	P100A	45 yds.	6
051131- 02698	216U	P80A	45 yds.	6

3M™ Green Corps™ Stikit™ Abrasive Sheets

3M’s “Better” abrasives have a durable mineral/bond construction and tough D-weight or E-weight paper backing that is fast-cutting and long-lasting. 246U sheets have 3M™ Fre-Cut™, which is a special treatment to resist loading. Excellent for coarse sanding of hull and deck areas, paint removal, scuffing between bottom paint coats and fairing.

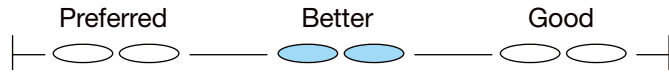

Part Number	Product ID	Grade	Sheets/Box	Rolls/Case
2-3/4" x 16-1/2"				
051131- 02230	246U	80D	100	5
051144- 02231	251U	40E	100	5
051144- 02232	251U	36E	100	5

3M™ Stikit™ Abrasive Sheet and Sheet Roll Accessories

3M™ Stikit™ Abrasive accessories are specially-made for use with 3M Stikit Abrasive sheets and sheet rolls. Both rubber and vinyl pad facing provides good adhesion so sheets won't slip or tear, and allows easy removal.

3M™ Stikit™ Hand Blocks

Made of a sturdy, durable, high-strength material and are shaped to fit the hand comfortably.



Part Number	Size	Pads/Case
051144-05440	2-3/4" x 5"	10
051144-05441	2-3/4" x 7-3/4"	10

3M™ Stikit™ Soft Hand Block

Made of a tough flexible foam which allows the user to block sand on flat surface or in contours. 3M™ Stikit™ Sheets adhere firmly to its vinyl face and won't slip or tear.

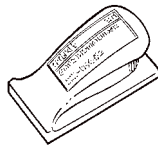

Part Number	Size	Pads/Case
051144-05442	2-3/4" x 5"	10

3M™ Stikit™ Soft Hand Pad,

For use with 3M™ Stikit™ Sheet Rolls. Provides a soft, controlled touch. Eliminates finger marks and edge cutting into primer and paint.



Part Number	Size	Pads/Box	Boxes/Case
051144-05530	2-3/4" Wide	5	10

3M™ Stikit™ Hand File Board

A well-balanced, durable tool that is resistant to most solvents, has a sturdy design that provides a non-twisting, flat sanding surface. This file board has an embossed rubber face that allows adhesion release when used with 3M™ Stikit™ File Sheets, 2-3/4" x 16-1/2." Can be cleaned with lacquer thinner.



Part Number	Abrasive Size	Boards/Case
051144-05444	2-3/4" x 16-1/2"	1

3M™ Stikit™ Air File Shoe

Specifically designed for use on all straight line air files and for use with our 3M™ Stikit™ File Sheets, 2-3/4" x 16-1/2." This air file shoe features a tuck-in clip on the leading edge for easy insertion and quick application of the file sheets plus the elimination of mechanical clips to make sheet removal easier.



Part Number	Abrasive Size	Shoes or Packs/Case
051144-05448	2-3/4" x 16-1/2"	10

3M™ Stikit™ Double Roll Dispenser for 2-3/4" Width Rolls

A portable, sturdy dispenser which holds two 2-3/4" width 3M™ Stikit™ Sheet Rolls for quick and easy dispensing. **NOTE: PRODUCTS DO NOT COME WITH THE DISPENSER.**



Part Number	Dispensers/Case
051144-05452	1

3M™ Hookit™ “Preferred” Abrasive Sheets and Sheet Rolls

3M™ Hookit™ Abrasive Sheets and Sheet Rolls incorporate a convenience hook-and-loop attachment system for easy attachment and removal. These sheets and rolls allow for reattachment and reuse, thus making them more economical. Use with 3M Hookit abrasive fairing boards, file boards, block, pads and shoes.

3M™ Imperial™ Hookit™ Abrasive Sheets and Sheet Rolls

3M's “Preferred” abrasive. Purple in color, which designates 3M's latest technology, greatest cost/value and highest quality abrasive. 3M™ Imperial™ Abrasives have several quality construction advantages which provide increased benefit and cost/value. P80 – P500 have a higher quality C-weight paper backing. Grits P36E – P80E have a higher quality E-weight paper backing. Both are designed to provide more durability, better cut and longer life. All grits are constructed of a high quality aluminum oxide mineral, with grits P36E – P180 having a unique blended mineral designed to cut faster and last longer. Excellent for use on tough marine gelcoat, paint and primer systems. Also outstanding on wood. Sheets come individually lined in boxes. Rolls are individually boxed.



3M™ Imperial™ Hookit™ Abrasive Sheets 334U, 734U and 740I

Part Number	Product ID	Grade	Sheets/ Box	Box/ Case
2-3/4" x 16-1/2"				
NEW 051131-01769	740I	60E	25	4
NEW 051131-01791	745I	P80E	25	4
NEW 051131-01793	740I	40E	25	4
NEW 051131-01794	740I	36E	25	4
NEW 051131-01860	334U	P320	50	5
NEW 051131-01861	334U	P240	50	5
NEW 051131-01862	334U	P220	50	5
NEW 051131-01863	734U	P180	50	5
NEW 051131-01864	734U	P150	50	5
NEW 051131-01865	734U	P120	50	5
NEW 051131-01866	734U	P100	50	5
NEW 051131-01867	734U	P80	50	5
4-1/2" x 30"				
051131-01868	334U	P320	10	5
051131-01869	334U	P240	10	5
051131-01870	334U	P220	10	5
051131-01871	734U	P180	10	5
051131-01872	734U	P150	10	5
051131-01873	734U	P120	10	5
051131-01874	734U	P100	10	5
051131-01875	734U	P80	10	5
NEW 051131-01876	745I	P80E	10	5
NEW 051131-01877	740I	P60E	10	5
NEW 051131-01878	740I	P40E	10	5
NEW 051131-01879	740I	P36E	10	5

3M™ Imperial™ Hookit™ Abrasive Sheet Rolls 334U, 734U and 740I

Part Number	Product ID	Grade	Length	Rolls/ Case
4-1/2"				
NEW 051131-01880	734U	P120	20 yds.	4
NEW 051131-01881	734U	P80	20 yds.	4
NEW 051131-01882	745I	P80E	20 yds.	4
NEW 051131-01883	740I	60E	20 yds.	4
NEW 051131-01884	740I	40E	20 yds.	4
NEW 051131-01885	740I	36E	20 yds.	4

3M™ Imperial™ Hookit™ Sheets 360L

This product earns the 3M Purple color which indicates the latest 3M technology, greatest cost/value and highest quality available. 3M™ Imperial™ Hookit™ Sheets 360L are high-performance sheets designed to cut faster and last longer on composite substrates enabling the user to obtain maximum usage from each sheet.

Part Number	Grade	Size	Sheets/ Box	Boxes/ Case
NEW 051115-19647	P1000	2-3/4" x 16-1/2"	100	5
NEW 051115-19648	P800	2-3/4" x 16-1/2"	100	5
NEW 051115-19649	P600	2-3/4" x 16-1/2"	100	5
NEW 051115-19650	P500	2-3/4" x 16-1/2"	100	5
NEW 051115-19651	P400	2-3/4" x 16-1/2"	100	5
NEW 051115-19652	P320	2-3/4" x 16-1/2"	100	5
NEW 051115-19653	P220	2-3/4" x 16-1/2"	100	5

3M™ Hookit™ Abrasive Sheet and Sheet Roll Accessories

These accessories are specially-made for use with 3M™ Hookit™ Abrasive Sheets and Sheet Rolls. The embossed face securely holds the abrasive, yet allows easy change and reattachment.

3M™ Marine Hookit™ Fairing Boards — Rigid and Flexible

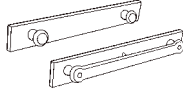

Designed for fairing, shaping, sanding and finishing boats, plugs and molds. These boards feature a durable, lightweight construction that combines worker comfort and getting desired results quickly.

The rigid fairing board can be used for large flat areas such as freeboard and deck areas. The flexible fairing board is for concave and convex curved areas such as hulls. These boards utilize 4-1/2" x 30" 3M™ Hookit™ Abrasive Sheets. Use 3M™ General Trim Adhesive (PN8088) for bonding the facing material to board surface.

Part Number	Type	Abrasive Size	Boards/Case
051144- 83497	Rigid	4-1/2" x 30"	1
051144- 83978	Flexible	4-1/2" x 30"	1

3M™ Hookit™ Soft Hand Block

Block is made of a tough, flexible foam for block sanding flat and contoured areas.



Part Number	Size	Blocks/Case
051131- 05742	2-3/4" x 5"	10

3M™ Hookit™ Hand Blocks

Made of a sturdy, durable high-strength material to fit the hand comfortably. The smaller block (PN05740) is designed to use one-third of a 3M™ Hookit™ Sheet while the larger block (PN05741) uses one-half of a 3M Hookit sheet.

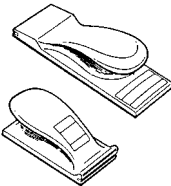

Part Number	Size	Blocks/Box	Blocks/Case
051131- 05740	2-3/4" x 5"	1	10
051131- 05741	2-3/4" x 7-3/4"	1	10

3M™ Hookit™ Marine Facing Material



A part of the 3M™ Marine Hookit™ Fairing Board/ Abrasive Sanding System. The 3M Hookit facing material allows conversion of self-made fairing boards to the 3M Hookit attachment system to utilize 4-1/2" x 30" 3M Hookit high performance abrasive sheets. Use 3M™ General Trim Adhesive (PN08088) for bonding 3M Hookit facing material to wood surface.

Part Number	Roll Size	Rolls/Case
051131- 50197	4-1/8" x 12'	5
051131- 82562	6" x 10'	1

3M™ Hookit™ Hand File Board

A well balanced, durable shop tool, that is resistant to most solvents. The sturdy design provides a non-twisting flat sanding surface.



Part Number	Abrasive Size	Blocks/Case
051131- 05744	2-3/4" x 16-1/2"	1

3M™ Hookit™ Air File Shoe

Specially designed for use on all straight air files with 3M™ Hookit™ File Sheets.



Part Number	Abrasive Size	Shoes/Case
051131- 05748	2-3/4" x 16-1/2"	5

3M™ Dry Lay-up Adhesive

This new adhesive from 3M is designed for use in dry lay up processes for vacuum infusion operations. It features a visible red color for easy identification of spray quantities as well as a dispersed particulate spray patten, and a fast strong tack level for holding the heaviest fiberglass fabrics. Available in both convenient 24 ounces aerosol and economical 5 gallon bulk sizes, this new adhesive is a must for all new infusion operations.

Part Number	Container Size	Containers/Case
NEW 051131- 09091	16.5 ounces	12
NEW 051131- 09092	5 Gallon Pail	1

3M™ Hookit™ Marine Rigid Fairing Board II

This new improved fairing board has a lightweight aluminum shoe that provides improved flatness allowing for more precise fairing jobs. It provides the user with a lightweight tool for fairing, shaping, sanding and finishing boat plugs and molds. It is rigid for flat surfaces such as freeboard and deck areas. This board utilizes the 4-1/2" x 30" 3M™ Hookit™ Abrasive Sheets in grades 36E to P320.

Part Number	Abrasive Size	Containers/Case
NEW 051131- 09082	4-1/2" x 30"	1

3M™ Floor Surfacing Abrasive Rolls

3M™ Floor Surfacing Rolls are the professionals' choice on drum sanding machines for commercial and residential jobs. They are recommended for general sanding on professional drum machines, especially for gummy finish removal. A sharp coating of durable mineral on a smooth, tough, flexible paper or combination backing gives the professional sander fast cuts, a professional finish, long life and time savings. The paper or combination backings can easily be cut to the size needed on professional machines where resurfacing of the drum changes the length of sheet needed.

3M™ Paper Rolls

- 3M™ Paper Rolls are also known as 3M™ Resinite™ Rolls
- Recommended for general drum sanding, especially for removing gummy finishes
- Short, synthetic mineral coating cuts fast
- Tough, paper backing can easily be cut to sizes needed

3M™ Floor Surfacing Paper Type E Rolls

The most economical way to buy sanding paper. Used extensively in Marine applications for "fairing" large areas of hulls, smoothing repair areas, as well as sanding "plugs" down before making molds for casting hulls and deck sections.

Part Number	Grade	Length	Pads/Case
8"			
051144- 15299	100 – 2/0	25 yds.	1
051144- 15300	80 – 1/0	25 yds.	1
051144- 15301	60 – 1/2	50 yds.	1
051144- 15302	50 – 1	50 yds.	1
051115- 07938	40 – 1-1/2	50 yds.	1
051115- 07921	36 – 2	50 yds.	1
051115- 07922	30 – 2-1/2	50 yds.	1
051115- 07934	24 – 3	50 yds.	1
12"			
051144- 15287	100 – 2/0	50 yds.	1
051144- 15288	80 – 1/0	50 yds.	1
051144- 15289	60 – 1/2	50 yds.	1
051144- 15290	50 – 1	50 yds.	1
051115- 07937	40 – 1-1/2	50 yds.	1
051115- 07923	36 – 2	50 yds.	1
051115- 07924	30 – 2-1/2	50 yds.	1
051115- 07935	24 – 3	50 yds.	1

3M™ Wetordry™ Sandpaper Sheets

3M™ Imperial™ Wetordry™ Paper Sheets 213Q

213Q utilize a premium, aluminum oxide mineral, an improved paper backing, and an optimized construction that results in the following performance advantages: improved rate of cut, increased abrasive life, increased flexibility, and uniform, consistent finish.



Part Number	Product ID	Grade	Sheets/ Sleeve	Sleeves/ Case
9" x 11"				
051131-02035	213Q	P800	50	5
051131-02036	213Q	P600	50	5
051131-02037	213Q	P500	50	5
051131-02038	213Q	P400	50	5
051131-02039	213Q	P360	50	5
051131-02040	213Q	P320	50	5
051131-02041	213Q	P280	50	5
051131-02042	213Q	P240	50	5
051131-02043	213Q	P220	50	5

3M™ Imperial™ Wetordry™ Improved Construction 401Q

This improved 3M™ Imperial™ Wetordry™ product is constructed of a silicone carbide mineral, better bonding system and more flexible backing. These features will provide faster cut, longer life, more consistent finish which will reduce sanding and buffing time. All grades are packed 5 sleeves per case.



Part Number	Product ID	Grade	Sheets/ Sleeve	Sleeves/ Case
5-1/2" x 9"				
051144-02021	401Q	Ultra Fine 1000	50	5
051131-02022	401Q	Micro Fine 1200	50	5
051131-02023	401Q	Micro Fine 1500	50	5
051131-02044	401Q	Micro Fine 2000	50	5
051131-02045	401Q	Micro Fine 2500	50	5
9" x 11"				
051131-02034	401Q	Ultra Fine 1000	50	5
051131-02033	401Q	Micro Fine 1200	50	5
051131-02032	401Q	Micro Fine 1500	50	5
051131-02020	401Q	Micro Fine 2000	50	5
051131-02019	401Q	Micro Fine 2500	50	5

3M™ Wetordry™ Tri-M-ite™ Paper Sheets 413Q and 431Q

Use wet or dry for sanding old finishes, fine featheredging plus surface work. It is a silicon carbide, closed coat product bonded with a waterproof resin.



Part Number	Product ID	Grade	Sheets/ Sleeve	Sleeves/ Case
A-weight – 9" x 11"				
051144-02000	413Q	600A	50	10
051144-02001	413Q	500A	50	5
051144-02002	413Q	400A	50	10
051144-02003	413Q	360A	50	5
051144-02004	413Q	320A	50	10
051144-02005	413Q	280A	50	5
051144-02006	413Q	240A	50	5
051144-02007	413Q	220A	50	10
C-weight – 9" x 11"				
051144-10695	431Q	400C	50	10
051144-10697	431Q	320C	50	5
051144-10699	431Q	240C	50	5
051144-02014	431Q	180C	50	5
051144-02015	431Q	150C	50	5
051144-02016	431Q	120C	50	5
051144-02017	431Q	100C	50	5
051144-02018	431Q	80C	50	5
051144-02019	431Q	60C	50	10

3M™ Wetordry™ Accessories

3M™ Wetordry™ Rubber Squeegees

Made of flexible rubber in two sizes. The 3" x 2" size is used for removing swarf created when sanding with water while the 2-3/4" x 4-1/4" size is used for applying glazing putty and plastic filler.



Part Number	Size	Each/Case
051144- 05517	2-3/4" x 4-1/4"	50
051144- 05518	3" x 2"	50

3M™ Wetordry™ Bucket

A durable rubber 3M bucket designed for use when wet sanding. Each bucket has a tray packed inside to store 3M™ Wetordry™ Paper, Squeegees and Blocks.



Part Number	Buckets/Case
051131- 02513	10

3M™ No. 20 Wetordry™ Sponge Pad

A firm hand sanding pad to be used with a three-fold wrap of 3M™ Wetordry™ Tri-M-ite™ Paper Sheets, 3M™ Imperial™ Wetordry™ Color Sanding Paper Sheets or 3M™ Production™ Gold Paper Sheets to make hand sanding easier and more efficient.



Part Number	Pads/Box	Pads/Case
051131- 05526	5	50

9" x 11" Sheet Accessories

3M™ Production™ Resinite™ Fre-Cut™ Gold Paper Sheets 216U

A premium, aluminum oxide mineral, an improved paper backing, and total construction that results in the following performance advantages: fast rate of cut, good flexibility, long abrasive life and uniform, consistent finish.



Part Number	Product ID	Grade	Sheets/ Sleeve	Sleeves/ Case
9" x 11"				
051131- 02536	216U	P800	50	5
051131- 02537	216U	P600	50	5
051131- 02538	216U	P500	50	5
051131- 02539	216U	P400	50	5
051131- 02540	216U	P360	50	5
051131- 02541	216U	P320	50	5
051131- 02542	216U	P280	50	5
051131- 02543	216U	P240	50	5
051131- 02544	216U	P220	50	5
051131- 02545	216U	P180	50	5
051131- 02546	216U	P150	50	5
051131- 02547	216U	P120	50	5
051131- 02548	216U	P100	50	5
051131- 02549	216U	P80	50	5
3-3/4" x 9"				
051131- 02551	216U	P320	100	5
051131- 02552	216U	P220	100	5
051131- 02553	216U	P180	100	5
051131- 02554	216U	P150	100	5
2-3/4" x 17-1/2"				
051131- 02567	216U	P220	50	5
051131- 02568	216U	P180	50	5
051131- 02569	216U	P150	50	5

3M™ Tri-M-ite™ Fre-Cut™ Paper Sheets 415N and 415U (Original Construction)

Dry sanding only by hand or machine. A specially treated paper with sharp silicon carbide mineral that resists loading when working on wood, plastic or fiberglass. Well suited for varnish sanding applications.



Part Number	Product ID	Grade	Sheets/ Min. Pkg.	Sleeves/ Case
9" x 11"				
051144- 14190	415N	320A	100	1000
051144- 14188	415N	280A	100	1000
051144- 14186	415N	240A	100	1000
051144- 14183	415U	220A	100	1000
051144- 14181	415U	180A	100	1000
051144- 14179	415U	150A	100	1000
051144- 14177	415U	120A	100	1000
051144- 14175	415U	100A	100	1000

3M™ Sanding Block

A pliable rubber block which holds the sandpaper securely during wet or dry sanding operations. It utilizes a 9" x 11" sheet torn or folded into fourths to make 2-3/4" x 9" sheets or for convenience use 3M pre-cut 2-3/4" x 9" sheets.



Part Number	Sheet Size	Blocks/Case
051144- 05519	2-3/4" x 9"	10

3M™ Rubber Sanding Block

The 3M™ Rubber Sanding Block is for use with 3M™ Wetordry™ Sanding Sheets and dry 9" x 11" sanding sheets for block sanding. This block is pliable for mild contours and designed to hold sandpaper sheets securely during wet or dry sanding operations. It utilizes a 9" x 11" sheet torn or folded into thirds to make 3" x 11" sheets.



Part Number	Sheet Size	Blocks/Case
051131- 05520	3" x 11"	10

Plastic Bulk Abrasives Rack 503

Each rack contains 8 plastic trays including bulk abrasives labels and headers kit. Case dimensions: 14" x 16-1/2" x 34-1/2".

Part Number	Racks/Case
051135- 64666	1

(Not stocked as a 3M item. Contact your Marine Sales Representative for ordering information.)

3M™ Sanding Sponges

3M™ Sanding Sponges are an innovation in coated abrasives for hand sanding applications. They provide superior flexibility and conformability to allow hand sanding in areas inaccessible to machine sanders. 3M sanding sponges feature various grade abrasive on a conformable foam pad, with a waterproof bonding system that allows them to be used either wet or dry. Great on wood, fiberglass, gelcoat, marine paints, metals and plastics.

3M™ Softback Sanding Sponges



Part Number	Grade	Sponges/ Box	Boxes/ Case
5-1/2" x 4-1/2" x 3/16"			
051131- 02600	Micro Fine	20	6
051131- 02601	Ultra Fine	20	6
051131- 02602	Super Fine	20	6
051131- 02604	Fine	20	6
051131- 02606	Medium	20	6

Part Number	Grade	Sponges/Case
5-1/2" x 4-1/2" x 3/16"		
051115- 07107	Super Fine	24
051115- 07108	Fine	24
051115- 07109	Medium	24
051115- 06964	Super Fine	250
051115- 06965	Fine	250
051115- 06966	Medium	250

3M™ Full-Size Sanding Sponges



Part Number	Grade	Sponges/Case
3-3/4" x 2-5/8" x 1"		
051115- 00409	Fine	24
051115- 00408	Medium	24
051115- 06968	Fine	250
051115- 06967	Medium	250

3M™ High Flexibility Sanding Sponges



Part Number	Grade	Sponges/Case
3-3/4" x 2-5/8" x 1/2"		
051115- 00631	Fine	24
051115- 00630	Medium	24

3M™ Woodworking Sanding Pad



Part Number	Grade	Pads/Case
4-3/4" x 3-3/4" x 1/2"		
051115- 51066	Fine	24
051115- 51065	Medium	24

Cloth Utility Rolls

3M™ Tri-M-ite™ Elek-Tro-Cut™ Cloth Utility Rolls 211K

For light deburring, clean-up, blending and finishing metal surfaces.



Part Number	Product ID	Grade	Length	Rolls/ Case
1"				
051144- 05002	211K	320J	50 yds.	5
051144- 05003	211K	280J	50 yds.	5
051144- 05004	211K	240J	50 yds.	5
051144- 05005	211K	220J	50 yds.	5
051144- 05006	211K	180J	50 yds.	5
051144- 05007	211K	150J	50 yds.	5
051144- 05008	211K	120J	50 yds.	5
051144- 05009	211K	100J	50 yds.	5

3M™ Tri-M-ite™ Elek-Tro-Cut™ Cloth Utility Rolls 211K (cont).

Part Number	Product ID	Grade	Length	Rolls/ Case
1-1/2"				
051144- 05022	211K	320J	50 yds.	5
051144- 05024	211K	240J	50 yds.	5
051144- 05025	211K	220J	50 yds.	5
051144- 05026	211K	180J	50 yds.	5
051144- 05027	211K	150J	50 yds.	5
051144- 05028	211K	120J	50 yds.	5
051144- 05029	211K	100J	50 yds.	5
051144- 05030	211K	80J	50 yds.	5
2"				
051144- 05042	211K	320J	50 yds.	5
051144- 05044	211K	240J	50 yds.	5
051144- 05045	211K	220J	50 yds.	5
051144- 05046	211K	180J	50 yds.	5
051144- 05047	211K	150J	50 yds.	5
051144- 05048	211K	120J	50 yds.	5
051144- 05049	211K	100J	50 yds.	5
051144- 05050	211K	80J	50 yds.	5

Miscellaneous Abrasive Racks and Accessories

3M™ Dry Guide Coat Cartridge and Kit

Dry powder with applicator used to highlight surface imperfections and sand scratches prior to finishing with abrasives. Can be used on marine fillers, primers, paints and gelcoat. Contains no solvents. Kit comes with applicator pad.



Part Number	Description	Quantity/Case
051131-05860	50 Gram Cartridge	10
051131-05861	50 Gram Cartridge and Applicator Kit	6

3M Abrasive Organizer

This organizer is red in color with a white 3M logo on the door. It can be hung on a wall or placed on a shelf. It has 2 hinged doors and is constructed of 24 gauge steel. It features 13 adjustable shelves and 1 permanent shelf with locking clasp for use with padlock. The dimensions are 32-5/8" wide, 12-1/8" deep and 30 1/6" high. The weight is 54 pounds. Not a 3M product. To order, call Shopware at 1-800-877-9344. **NOTE: PRODUCTS DO NOT COME WITH THE ORGANIZER.**



Part Number	Each/Case
051131-02500	10

(Not stocked as a 3M item).

3M Coated Abrasive Rapid Transit System C.A.R.T.S.

This three-shelf cart is made of eighteen gauge sturdy metal, with fourteen gauge uprights and 5" rubber caster wheels. The cart has a capacity of 400 pounds in its three large storage areas. The dimensions are 19-3/4" x 29-1/2" x 32" high. Some assembly is required. **Not a 3M product. To order, call Shopware at 1-800-877-9344.**



Part Number	Each/Case
051131-02510	1

(Not stocked as a 3M item).

3M Portable Automotive Refinish Table Stand P.A.R.T.S.

This table top frame has rounded corners on the shelf and legs and is made of sixteen gauge steel tubular frame construction. It is easily adjustable to four positions. The frame weights only 30-1/2 pounds. The maximum weight limit on the table top form is 200 pounds. The dimensions (table top form) are 30-1/2" wide x 36" long x 34-1/4" high. Some assembly is required. **Not a 3M product. To order, call Shopware at 1-800-877-9344.**



Part Number	Each/Case
051131-02514	10

(Not stocked as a 3M item).

3M Woodworking Belt Selection Guide

Wide Belt Sanding

Recommend a stock removal of a few thousandths of an inch before entering the finishing sanding head to leave a flat and sanded surface. Avoid high sanding pressure to increase belt life. The platen head's performance is affected by the makeup of the platen pad. Use a soft platen pad cushion to produce a milder sanding scratch pattern. Confine soft cushions for operations using 180-grit and finer abrasives. Soft cushions used with coarse sanding will cause over-cutting of soft grains and edge dumping.



Edge Sanding

Edge sanding involves the sanding of flat, narrow surfaces with small surface areas like panel edges. Additionally, a variety of cases, tables and chairs (some having band sawn surfaces) are sanded on this type of equipment.



Portable Belt Sanding

Coarse grades remove wood stock to a uniform dimension, leaving enough wood to develop the final finish. The finishing grade(s) remove all previous abrasive grit scratches. Have no more than a two-grade jump between rough and finish sanding. For example, rough sand with 36-grit, followed by no finer than 50-grit.



International Measurement Conversion Chart

All specification in this catalog are presented in U.S. units of measurement. To the right is a chart for converting these measurements to international units of measure.

U.S. Unit of Measure	Conversion Formula	International Unit of Measure
Inch	x 25.4	Millimeter
Pound	x .454	kg
PSI	÷ 14.7	Bar
SFPM	x .3048	SMPM
SCFM	x 28.32	LPM
HP	x 745.7	W

High Performance Purple*

Designed to provide the lowest overall manufacturing costs.

	Backing	Wide Belt Sanding	Edge Sanding	Portable Belt Sanding
3M ID				
761D	Y			X
900DZ	J			
930DZ	X		X	
961UZ	F	X		
970DZ	X or Y	X	X	

*The Purple color of the abrasive is a trademark of 3M.

General Purpose

The best product when price is a major consideration.

	Backing	Wide Belt Sanding	Edge Sanding	Portable Belt Sanding
3M ID				
240D	X	X	X	X
241D	X	X	X	X
251U	E	X		

Engineered

The standard of the industry

	Backing	Wide Belt Sanding	Edge Sanding	Portable Belt Sanding
3M ID				
200D	J		X	
200DZ	J		X	
240A	X	X	X	
270D	F	X	X	
362UZ	Y	X		
363UZ	F	X		

Your 3M Solutions Hotlines:

3M can provide additional products and accessories to meet your needs. Please contact us in any of the following ways that you prefer:

- 3M distributor or 3M sales representative in your area
- 3M Customer Response Center **1-866-279-1235**
- 3M Custom Woodworking and Cabinet Shop Website **www.3M.com/woodworking-catalog**

3M™ Stikit™ Dust-Free Abrasives

3M™ Stikit™ Dust-Free Abrasives are pressure-sensitive adhesive backed for easy application and removal. They are pre-punched with a standard hole pattern for dust-free sanding. Use with 3M Stikit dust-free abrasive back-up pads.

3M™ Stikit™ Dust-Free Gold Abrasive Disc Rolls

3M's "Better" abrasives have a tough, durable aluminum oxide mineral. They are aggressive, sharp, fast cutting and long lasting. Gold disc roll construction also resists dulling, excess edge wear, and these discs have 3M™ Fre-Cut™, which is a special treatment designed to prevent loading. 3M™ Stikit™ Dust-Free Gold Abrasive Disc Rolls 216U have a lighter A-weight paper backing. 3M Stikit dust-free gold abrasive disc rolls 236U have a heavier C-weight paper backing for excellent support, and these discs have clear, non-staining 3M Fre-Cut. They can be conveniently dispensed using the 3M Stikit disc roll dispenser (PN05450).



3M™ Stikit™ Dust-Free Gold Abrasive Disc Rolls 216U – A-weight

Part Number	Product ID	Grade	Discs/ Roll	Rolls/ Case
5"				
051131-01619	216U	P400	175	6
051131-01620	216U	P320	175	6
051131-01621	216U	P280	175	6
051131-01622	216U	P240	175	6
051131-01623	216U	P220	175	6
051131-01624	216U	P180	175	6
051131-01625	216U	P150	175	6
051131-01626	216U	P120	125	10
051131-01627	216U	P100	125	10
051131-01628	216U	P80	175	10
6"				
051131-01633	216U	P500	175	6
051131-01634	216U	P400	175	6
051131-01635	216U	P320	175	6
051131-01636	216U	P280	175	6
051131-01637	216U	P240	175	6
051131-01638	216U	P220	175	6
051131-01639	216U	P180	175	6
051131-01640	216U	P150	175	6
051131-01641	216U	P120	125	10
051131-01642	216U	P100	125	10
051131-01643	216U	P80	125	10

3M™ Stikit™ Dust-Free Gold Abrasive Disc Rolls 236U – C-weight, (Non-Staining 3M™ Fre-Cut™)



Prepunched with standard hole patterns for dust-free sanding and are designed to be used with 3M™ Stikit™ Dust-Free Disc Pads. 3M Stikit dust-free gold discs 236U come in roll form for use with 3M Stikit disc roll dispenser (PN05450) or 3M Stikit light duty dispensers (PN05455 for 5" discs and PN05456 for 6" discs) and are available in "C" weight in a full range of grades. Discs have a pressure-sensitive adhesive backing for easy application and removal.

Part Number	Product ID	Grade	Discs/ Roll	Rolls/ Case
5"				
051144-88707	236U	P500	100	4
051144-88706	236U	P400	100	4
051144-88705	236U	P320	100	4
051144-88704	236U	P240	100	4
051144-88703	236U	P220	100	4
051144-88702	236U	P180	100	4
051144-88701	236U	P150	100	4
051144-88700	236U	P120	100	4
6"				
051144-86487	236U	P500	100	4
051144-86486	236U	P400	100	4
051144-86485	236U	P320	100	4
051144-86484	236U	P240	100	4
051144-86483	236U	P220	100	4
051144-86482	236U	P180	100	4
051144-86481	236U	P150	100	4
051144-86480	236U	P120	100	4
051144-86479	236U	P100	100	4
051144-86478	236U	P80	100	4

3M™ Stikit™ Dust-Free Abrasives

3M™ Green Corps™ Stikit™ Dust-Free Abrasives 215U and 246U

3M's "Better" abrasives have a durable mineral/bond construction and tough D-weight or E-weight paper backing that is fast-cutting and long-lasting. 246U discs have 3M™ Fre-Cut™, which is a special treatment to resist loading. These discs are excellent for coarse sanding of hull and deck areas, paint removal, scuffing between bottom paint coats and fairing. 246U discs come in a convenient disc roll, while 251U discs are individually lined.



Part Number	Product ID	Grade	Discs/ Box or Roll	Boxes or Rolls/ Case
5"				
051131- 01561*	246U	80D	100/Roll	10
051131- 01665	251U	40E	100/Box	5
6"				
051131- 01566*	246U	80D	100/Roll	10
051131- 01667	251U	40E	100/Box	5
051131- 01668	251U	36E	100/Box	5
051131- 01569*	246U	80D	100/Roll	5
8"				
051131- 01660	241U	40E	50/Box	5
051131- 01661	251U	36E	50/Box	5

*Free-Cut™ Discs

3M™ Stikit™ Dust-Free Abrasive Disc Back-Up Pads

3M™ Stikit™ Dust-Free Abrasive Disc Back-Up Pads are specially-made for use with 3M Stikit dust-free abrasive discs with a standard hole pattern for dust-free sanding. Vinyl pad facing provides good adhesion of the discs, yet allows easy disc removal. Disc pads are lightweight, shock resistant and well balanced. See Maximum Safe Operating Speed (MOS) for each pad.

3M™ Stikit™ Dust-Free Disc Pad

For use in most sanding applications.



Part Number	Use with Disc Size	MOS	Pads/Case
051131-45217	5"	10,000 RPM	10
051131-45218	6"	10,000 RPM	10

3M™ Stikit™ Dust-Free Low Profile Disc Pad

Designed to assist marine refinishers in sanding under rub rails, roe rails, along chines and rudder posts. The foam construction enhances the operator's "feel" in final fairing and finishing applications.



Part Number	Use with Disc Size	MOS	Pads/Case
051131-05655	5"	12,000 RPM	10
051131-05656	6"	10,000 RPM	10

3M™ Stikit™ Dust-Free Low Profile Finishing Disc Pad

Soft foam construction for fine finish sanding. Offers outstanding conformability to contours and curves. Use on random orbital sanders only.



Part Number	Use with Disc Size	MOS	Pads/Case
051131-05645	5"	12,000 RPM	10
051131-05646	6"	10,000 RPM	10

3M™ Stikit™ Disc Pad – Replacement 8"

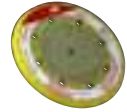

Part Number	Description	MOS	Pads/Case
051131-05682	Chicago Pneumatic	1,500 RPM	10

Porter-Cable Disc Pad

For use with Models 333 and 334. 3-bolt holes.



Part Number	Use with Disc Size	MOS	Pads/Case
051111-50206	5" x 1/2"	12,000 RPM	5

DeWalt® Disc Pad

For use with Models DW421, 422 and 423. 3-bolt holes.



Part Number	Use with Disc Size	MOS	Pads/Case
051111-50207	5" x 1/2"	12,000 RPM	5

DeWalt is a registered trademark of DeWalt Industrial Tool Company.

Bosch Disc Pad

For use with Model #3107 DWS. 3-bolt holes.



Part Number	Use with Disc Size	Pads/Case
051111-50208	5" x 1/2"	5

3M™ Hookit™ “Preferred” Dust-Free Abrasives

3M™ Hookit™ Dust-Free Abrasives incorporate a convenience hook-and-loop attachment system for easy attachment and removal. They are pre-punched with various hole pattern for dust-free sanding. Use with These discs allow for reattachment and reuse, thus making them more economical. Use with 3M Hookit dust-free abrasive back-up pads for discs with standard hole pattern.

3M™ Imperial™ Hookit™ Dust-Free Abrasives

3M's preferred abrasive. Purple in color, which designates 3M's latest technology, greatest cost/value and highest quality abrasive. 3M™ Imperial™ Abrasives have several quality construction advantages which provide increased benefit and cost/value. P80 – P500 have a higher quality C-weight paper backing. Grits P36E – P80E have a higher quality E-weight paper backing. Both are designed to provide more durability, better cut and longer life. All grits are constructed of a high quality aluminum oxide mineral, with grits P36E – P180 having a unique blended mineral designed to cut faster and last longer. Excellent for use on tough marine gelcoat, paint and primer systems. Also outstanding on wood. 3M™ Imperial™ Hookit™ Dust-Free Abrasives come in three hole patterns for dust-free sanding: standard pattern, pattern for Fein equipment, and 12-hole pattern on 8" discs. They are boxed, individually lined discs.



3M™ Imperial™ Hookit™ Dust Free Abrasives 334U, 734U, 740I and 745I

Part Number	Product ID	Grade	Pattern	Discs/Box	Box/Case
5"					
NEW 051131-01795	334U	P500	Standard	50	4
NEW 051131-01796	334U	P400	Standard	50	4
NEW 051131-01797	334U	P320	Standard	50	4
NEW 051131-01798	334U	P280	Standard	50	4
NEW 051131-01799	334U	P240	Standard	50	4
NEW 051131-01800	734U	P220	Standard	50	4
NEW 051131-01801	734U	P180	Standard	50	4
NEW 051131-01802	734U	P150	Standard	50	4
NEW 051131-01803	734U	P120	Standard	50	4
NEW 051131-01804	734U	P100	Standard	50	4
NEW 051131-01805	734U	P80	Standard	25	4
NEW 051131-01806	745I	P80E	Standard	25	4
NEW 051131-01807	740I	60E	Standard	25	4
NEW 051131-01808	740I	40E	Standard	25	4
NEW 051131-01809	740I	36E	Standard	25	4

Part Number	Product ID	Grade	Pattern	Discs/Box	Box/Case
6"					
NEW 051131-01810	334U	P500	Standard	50	4
NEW 051131-01811	334U	P400	Standard	50	4
NEW 051131-01812	334U	P320	Standard	50	4
NEW 051131-01813	334U	P280	Standard	50	4
NEW 051131-01814	334U	P240	Standard	50	4
NEW 051131-01815	334U	P220	Standard	50	4
NEW 051131-01816	734U	P180	Standard	50	4
NEW 051131-01817	734U	P150	Standard	50	4
NEW 051131-01818	734U	P120	Standard	50	4
NEW 051131-01819	734U	P100	Standard	50	4
NEW 051131-01820	734U	P80	Standard	50	4
NEW 051131-01821	745I	P80E	Standard	25	4
NEW 051131-01822	740I	60E	Standard	25	4
NEW 051131-01823	740I	40E	Standard	25	4
NEW 051131-01824	740I	36E	Standard	25	4
NEW 051131-01825	334U	P320	Fein	50	4
NEW 051131-01826	334U	P280	Fein	50	4
NEW 051131-01827	334U	P240	Fein	50	4
NEW 051131-01828	334U	P220	Fein	50	4
NEW 051131-01829	734U	P180	Fein	50	4
NEW 051131-01830	734U	P150	Fein	50	4
NEW 051131-01831	734U	P120	Fein	50	4
NEW 051131-01832	734U	P100	Fein	50	4
NEW 051131-01833	734U	P80	Fein	50	4
NEW 051131-01834	745I	P80E	Fein	25	4
NEW 051131-01835	740I	60E	Fein	25	4
NEW 051131-01836	740I	40E	Fein	25	4
NEW 051131-01837	740I	36E	Fein	25	4
8"					
NEW 051131-01844	334U	P320	Standard	25	4
NEW 051131-01845	334U	P220	Standard	25	4
NEW 051131-01846	334U	P180	Standard	25	4
NEW 051131-01847	734U	P150	Standard	25	4
NEW 051131-01848	734U	P120	Standard	25	4
NEW 051131-01849	734U	P80	Standard	25	4
NEW 051131-01850	734U	P80E	Standard	25	4
NEW 051131-01851	745I	60E	Standard	25	4
NEW 051131-01852	740I	40E	Standard	25	4
NEW 051131-01853	740I	36E	Standard	25	4
NEW 051131-01854	734U	P120	12-Hole	25	4
NEW 051131-01855	734U	P80	12-Hole	25	4
NEW 051131-01856	734U	P80E	12-Hole	25	4
NEW 051131-01857	745I	60E	12-Hole	25	4
NEW 051131-01858	740I	40E	12-Hole	25	4
NEW 051131-01859	740I	36E	12-Hole	25	4

3M™ Hookit™ “Preferred” Dust-Free Abrasives

3M™ Imperial™ Hookit™ Dust-Free Abrasives 360L

High quality abrasive discs designed to cut faster and last longer on composite substrates, enabling the user to obtain maximum usage from each disc. Designed for use on gelcoat. Discs come conveniently boxed. Not recommended for sanding coatings, as this abrasive contains no 3M™ Fre-Cut™ to prevent loading.



Part Number	Product ID	Grade	Discs/Box	Box/Case
5"				
NEW 051115- 19629	360L	P1000	100	5
NEW 051115- 19630	360L	P800	100	5
NEW 051115- 19631	360L	P600	100	5
NEW 051115- 19632	360L	P500	100	5
NEW 051115- 19633	360L	P400	100	5
NEW 051115- 19634	360L	P320	100	5
NEW 051115- 19635	360L	P280	100	5
NEW 051115- 19636	360L	P240	100	5
NEW 051115- 19637	360L	P220	100	5
6"				
NEW 051115- 19638	360L	P1000	100	5
NEW 051115- 19639	360L	P800	100	5
NEW 051115- 19640	360L	P600	100	5
NEW 051115- 19641	360L	P500	100	5
NEW 051115- 19642	360L	P400	100	5
NEW 051115- 19643	360L	P320	100	5
NEW 051115- 19644	360L	P280	100	5
NEW 051115- 19645	360L	P240	100	5
NEW 051115- 19646	360L	P220	100	5

3M™ Hookit™ Dust-Free Finishing Film Discs 260L

Designed for use in scuff sanding before painting, as well as to remove runs, dust nibs, and excess orange peel from paint and gelcoat prior to compounding. 3M™ Hookit™ standard hole patterns for dust-free sanding and are designed to be used with 3M Hookit dust-free disc pads. These discs allow for machine sanding versus having to hand sand prior to compounding or using very aggressive compounds (multiple applications of). These discs are constructed of a high-performance, aluminum oxide mineral bonding to a smooth film backing. Cuts fast, lasts long, resists loading and leaves a consistent finish.



Part Number	Product ID	Grade	Discs/Box	Box/Case
5"				
051131- 01053	260L	P1000	100	4
051131- 01055	260L	P600	100	4
6"				
051131- 01050	260L	P1500	100	4
051131- 01068	260L	P1200	100	4
051131- 01069	260L	P1000	100	4
051131- 01070	260L	P800	100	4
051131- 01071	260L	P600	100	4

3M™ Hookit™ Dust-Free Abrasive Disc Back-Up Pads

3M™ Hookit™ Dust-Free Abrasive Disc Back-Up Pads are specially-made for use with 3M Hookit dust-free abrasive discs with a standard hole pattern for dust-free sanding. The pad face securely holds the discs, yet allows easy change and reattachment of the disc. Disc pads have conformable foam body with a durable plastic hub and are lightweight, shock resistant and well balanced. See Maximum Safe Operating Speed (MOS) for each pad.

3M™ Hookit™ Dust-Free Disc Pads

For use in most sanding applications.



Part Number	For Use with Disc Size	MOS	Pads/Case
051131-82659	5"	12,000 RPM	10
051131-05876	6"	12,000 RPM	10

3M™ Hookit™ Dust-Free Low Profile Disc Pads

Designed to assist marine refinishers in sanding under rub rails, roe rails, along chines and rudder posts. The foam construction enhances the operator's "feel" in final fairing and finishing applications.

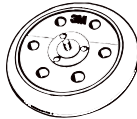

Part Number	For Use with Disc Size	MOS	Pads/Case
051131-05885	5"	12,000 RPM	10
051131-05856	6"	12,000 RPM	10

3M™ Hookit™ Dust-Free Low Profile Finishing Disc Pads

Soft foam construction for fine finish sanding. Offers outstanding conformability to contours and curves. Use on random orbital sanders only.



Part Number	For Use with Disc Size	MOS	Pads/Case
051144-77856	5"	12,000 RPM	10

3M™ Hookit™ Soft Interface Disc Pads

These soft interface pads are a very flexible foam which attach to a standard 3M™ Hookit™ disc pad to provide excellent full disc contact, even on curved surfaces.



Part Number	For Use with Disc Size	Pads/Case
051131-05771	3"	10
051131-05773	5"	10
051131-05774	6"	10

Hookit™ Manufacturer Specific Disc Pads

DeWalt® Disc Pad

For use with Models DW421, 422 and 423. 3-bolt holes.



Part Number	For Use with Disc Size	MOS	Pads/Case
051111-50204	5" x 1/2"	12,000 RPM	5

DeWalt is a registered trademark of DeWalt Industrial Tool Company.

Porter-Cable Disc Pad

For use with Models 333 and 334. 3-bolt holes.



Part Number	For Use with Disc Size	MOS	Pads/Case
051111-50205	5" x 1/2"	12,000 RPM	5

Bosch Disc Pad

For use with Model #13107 DVS. 7mm bolt holes.



Part Number	For Use with Disc Size	MOS	Pads/Case
051111-50203	5" x 1/2"	12,000 RPM	5

Retail Packaged Abrasive Products

3M™ Aluminum Oxide Sandpaper

Aluminum oxide abrasive is tough, durable and long-lasting. Use to sand wood, paints, metal, plastic, drywall and fiberglass.



Part Number	Grade	Size	Sheets/ Pack	Packs/ Case
051144-09001	Fine 150	9" x 11"	5	20
051144-09002	Medium 100	9" x 11"	5	20
051144-09003	Coarse 60	9" x 11"	5	20
051144-09005	Assorted	9" x 11"	5	20

3M™ Wetordry™ Sandpaper

3M™ Wetordry™ Sandpaper allows you to sand between coats of varnish and paint or other finishes. Can be used with water to reduce clogging and extend abrasive life. Ideal for sanding metal for repainting or prior to primer coat.



Part Number	Grade	Size	Sheets/ Pack	Packs/ Case
051144-09084	Ultra Fine 600	9" x 11"	5	50
051144-09085	Super Fine 400	9" x 11"	5	50
051144-09086	Extra Fine 320	9" x 11"	5	50
051144-09087	Very Fine 240	9" x 11"	5	50
051144-09088	Assorted	9" x 11"	5	50

*Contains 1 sheet VF and 2 sheets SF and EF

3M™ Stripping Pad

The 3M™ Stripping Pad is designed for use with chemical strippers in removing paint and varnish. Made from a tough, non-woven synthetic material that won't rust or splinter like steel wool.



Part Number	Pads/Case
051144-07413	10

3M™ Metal Finishing Pad

The 3M™ Metal Finishing Pad is designed for removing light rust; cleaning and brightening metal. Made from a tough, non-woven synthetic material that won't rust or splinter like steel wool.



Part Number	Pads/Case
051144-07414	10

3M™ Wood Finishing Pad

The 3M™ Wood Finishing Pad is designed for smoothing bare wood, rubbing in furniture oils and denibbing between coats of stain, sealer or varnish. Made from a tough, non-woven synthetic material that won't rust or splinter like steel wool.



Part Number	Pads/Case
051144-07415	10

3M™ Flexible Sanding Sponge

A urethane foam sponge for sanding contoured and hard-to-reach surfaces. Has tough aluminum oxide abrasive on all four sides. Reusable. Rinse clean, squeeze and use again. One sponge per pack. Sponges are 3-3/4" x 2-5/8" x 1".



Part Number	Grade	Packs/Case
051131-50038	Fine/Medium	24
051131-50037	Medium/Coarse	24

3M™ Rubber Sanding Block

Makes hand sanding easy and fast on flat and curved surfaces. Made of pliable rubber for a comfortable grip and better control. For use with regular sandpaper.



Part Number	Blocks/Case
021200-09292	10

3M™ All-Purpose Tack Cloth

Safely removes dirt, lint, dust and sanding particles from fiberglass, metal, plastic, wood and wallboard surfaces prior to painting or staining. Excellent for a number of marine applications.



Part Number	Size	Cloths/Pack	Packs/Case
051144-03192	16" x 20"	1	40

3M™ Adhesive Backed Sandpaper Discs – 5"

3M™ Adhesive Backed Discs have a pressure-sensitive backing that requires no holding or fastening devices. These discs last longer and won't tear like ordinary discs because the disc sticks to the entire pad surface.



Part Number	Grade	Discs/Pack	Packs/Case
051144-09170	Fine	5	20
051144-09171	Medium	5	20
051144-09172	Coarse	4	20

3M™ Adhesive Backed Sanding Kit – 5" Disc

Kit contains three 3M™ Adhesive Backed Discs (1 each fine, medium, coarse) plus one 5" adhesive backed disc pad.



Part Number	Kits/Case
051144-09176	10

Retail Packaged Abrasive Products

3M™ Hookit™ Discs 5" – Kit

Use for sanding fiberglass, gelcoat, paint, wood, and metal. Hook-and-loop system holds securely for long disc use. Reduces clogging, extends disc life. Accommodates most 5-inch dustless sanders. Available in extra fine, fine, medium and coarse grades.



Part Number	Description	Discs/ Pack	Packs/ Case
Kit			
051144-09173	1 pad, 1 Medium 80 disc	3	8
Discs – No Hole			
051144-09140	Extra Fine – 220 Grit	3	40
051144-09141	Fine – 120 Grit	3	40
051144-09025	Medium – 80 Grit	3	40
051144-09026	Coarse – 40 Grit	3	40
Dust-Free Discs – 8 hole			
051144-09145	Extra Fine – 220 Grit	3	40
051144-09146	Fine – 120 Grit	3	40
051144-09147	Medium – 80 Grit	3	40
051144-09027	Coarse – 40 Grit	3	40

3M™ Hookit™ Dust-Free Discs

Use for sanding fiberglass, gelcoat, paint, wood, and metal. Hook-and-loop system holds discs securely. Special coating reduces clogging, extends disc life. Available in extra fine, fine, medium and coarse grades.



Part Number	Description	Discs/ Pack	Packs/ Case
4" x 8 Hole			
051144-09205	Extra Fine – 220 Grit	3	40
051144-09206	Fine – 120 Grit	3	40
051144-09207	Medium – 80 Grit	3	40
051144-09208	Coarse – 40 Grit	3	40
5" x 5 Hole			
051144-09305	Extra Fine – 220 Grit	3	40
051144-09307	Fine – 120 Grit	3	40
051144-09308	Medium – 80 Grit	3	40
051144-09030	Coarse – 40 Grit	3	40
6" x 6 Hole			
051144-09312	Extra Fine – 220 Grit	3	40
051144-09314	Fine – 120 Grit	3	40
051144-09315	Medium – 80 Grit	3	40
051144-09031	Coarse – 40 Grit	3	40

3M™ Drill Mounted Grinding/ Sanding/Finishing System

The 2" 3M™ Grinding Discs are great for hard-to-reach areas. Quick, interchangeable, reusable attachment system yields professional results. Unique quality tools are compatible with electric and air drills. 3M™ Regalite™ Discs grind through paint, primer, filler and rust. Great for leveling welds. Scotch-Brite™ Discs are outstanding for gasket removing and metal polishing.



Part Number	Description	Quantity/ Pack	Packs/ Case
051131-03050	Finishing Kit Consisting of: 1 Disc Holder, 3 – 2" 3M™ Regalite™ Sanding Discs, 2 – 2" Scotch-Brite™ Discs	1 Kit	6
051131-03051	2" Disc Holder	1 Holder	10
051131-03055	Scotch-Brite™ Polishing Discs Fine	3 Discs	10
051131-03057	Scotch-Brite™ Stripping Discs Coarse	3 Discs	10

Scotch-Brite™ Medium Finishing Sander

Mounts directly to power drills by inserting the mandrel into a drill chuck. Use for light sanding of fiberglass, gelcoat, wood, or metal. Drum shape makes it ideal for curves, contours and hard-to-reach areas.



Part Number	Packs/Case
051144-09415	10

Scotch-Brite™ Fine Finishing Sander

Mounts directly to power drills by inserting the mandrel into a drill chuck. Use for finish sanding on fiberglass, gelcoat, wood, or metal. Drum shape makes it ideal for curves, contours and hard-to-reach areas.



Part Number	Packs/Case
051144-09416	10

Scotch-Brite™ Flat Surface

Attaches to a 3M™ Hook-and-Loop Backup Pad. The disc is for use on flat projects requiring fast removal of surface paint and rust from wood, metal and plastic.



Part Number	Packs/Case
051144-09410	12

Retail Packaged Abrasive Products

Scotch-Brite™ Flat Surface Paint and Rust Stripper Kit

3M™ Hook-and-Loop Backup Pad mounts directly to power drill chuck. Hook-and-loop disc mounts to backup pad. Use on flat projects requiring fast removal of surface paint and rust from wood, metal and plastic.



Part Number	Kits/Case
051111-10954	5

Scotch-Brite™ Flat Surface Paint and Varnish Remover Kit

3M™ Hook-and-Loop Backup Pad mounts directly to power drill chuck. Hook-and-loop disc mounts to backup pad. Use on flat projects requiring fast removal of surface paint and varnish from wood, metal and plastic.



Part Number	Kits/Case
051111-10955	5

3M™ Auto-Pak™ Power Rust and Paint Stripper

A one-piece stripper, with a built-in mandrel, that quickly removes rust scale, old paint and grime from metal surfaces. It is made of a synthetic material that molds to any surface and won't rust or splinter like wire brushes.



Part Number	Strippers/Pack	Packs/Case
051131-03171	1	24

Scotch-Brite™ Heavy Duty Rust and Paint Stripper

This double thick Scotch-Brite™ web strips quick, lasts long, and cuts fast. It conforms to surface contours and attaches easily to a standard electric drill.



Part Number	Description	Packs/Case
051131-03172	4" Diameter	24

Scotch-Brite™ Flat Surface Paint and Varnish Remover Disc

Attaches to a 3M™ Hook-and-Loop Backup Pad. The disc is for use on flat projects requiring fast removal of surface paint and varnish from wood, metal and plastic.



Part Number	Packs/Case
051144-09411	12

Scotch-Brite™ Contour Surface Paint and Varnish Remover

Mounts directly to power drills by inserting the mandrel into a drill chuck. Use for removal of paint and varnish from contoured surfaces on wood, metal and plastic.



Part Number	Packs/Case
051144-09413	9

Scotch-Brite™ Large Area Paint and Varnish Remover

Mounts directly to power drills by inserting the mandrel into a drill chuck. Use for removal of paint and varnish from contoured surfaces on wood, metal and plastic. Double-wide for removal of paint and varnish from large areas.



Part Number	Packs/Case
051144-09414	10

3M™ SandBlaster™ Between Coats Sanding Sponges

Sanding sponges are ideal for fine sanding between paint or varnish coats. Comprised of an electrostatically coated, self-sharpening aluminum oxide mineral for increased durability and worklife.

Part Number	Grit	Size	Sponges/Case
051111-11517	Fine/180	2.625" x 3.75" x 1"	12
051111-50673	Fine/320	2.625" x 3.75" x 1"	12

3M™ SandBlaster™ Bare Surfaces Sanding Sponges

These sanding sponges allow easy surface preparation for bare wood, metal or drywall. Made of an electrostatically coated ceramic aluminum oxide mineral blend for increased durability and worklife. They sand faster and last longer than conventional sanding sponges of comparable grit.

Part Number	Grit	Size	Sponges/Case
051111-50675	Med/100	2.625" x 3.75" x 1"	12
051111-50677	Med/150	3.75" x 2.5" x 1"	12
051111-50679	Med/80	2.625" x 3.75" x 1"	12

3M™ SandBlaster™ Paint Stripping Sanding Sponges

Used for fast removal of paint, varnish and clear coat, these sanding sponges are ideal for use on wood and metal. Comprised of an electrostatically coated silicon carbide mineral for increased durability and worklife. They sand faster and last longer than conventional sanding sponges of comparable grit.

Part Number	Grit	Size	Sponges/Case
051111-11515	Coarse/36	2.625" x 3.75" x 1"	12
051111-11516	Coarse/60	3.75" x 2.5" x 1"	12

Retail Packaged Abrasive Products

3M™ All-Purpose Sanding Sponges

Ideal for dry or wet sanding of wood, paint, metal, plastic and drywall. A combination of two sanding grades on one sponge. When finished, simply rinse and reuse. Handy contractor pack case.

Part Number	Grit	Size	Sponges/ Case
051131- 85076	Fine/ Medium	3.75" x 2.625" x 1"	24
051131- 85097	Medium/ Coarse	3.75" x 2.625" x 1"	24

3M™ All-Purpose Sanding Sponges

Ideal for dry or wet sanding of wood, paint, metal, plastic and drywall. When finished, simply rinse and reuse. Handy contractor pack case.

Part Number	Grit	Size	Sponges/ Case
051131- 85098	Fine	3.75" x 2.625" x 1"	24
051131- 85099	Medium	3.75" x 2.625" x 1"	24

3M™ Full Size Sanding Sponges

Ideal for dry or wet sanding of wood, paint, metal, plastic and drywall. When finished, simply rinse and reuse. Conformable, comfortable, flexible and convenient.

Part Number	Grit	Size	Sponges/ Case
051115- 00409	Fine	3.75" x 2.625" x 1"	24
051115- 00408	Medium	3.75" x 2.625" x 1"	24

3M™ SandBlaster™ Quick Change Hub for Right Angle Grinder

Quick loading adapter.

Part Number	Size	Quantity/Case
051111- 54762	4.5"	10

3M™ SandBlaster™ Right Angle Grinder Sanding Discs

Assorted grits. 3-pack.

Part Number	Grits	Size	Quantity/Case
051111- 54764	36, 60, 120	4.5"	10

3M™ SandBlaster™ Right Angle Grinder Multi-Layer Discs

Part Number	Grits	Size	Quantity/Case
051111- 54763	36	4.5"	10
051111- 54765	60	4.5"	10

3M™ SandBlaster™ Multi-Layer Discs

Part of a unique quick-loading system for the angle grinder. Must be used with quick loading adapter. Ideal for metal grinding, rust removal and aggressive coating removal from wood.

Part Number	Grit	Size	Quantity/Case
051111- 54766	120	4.5"	10

3M™ SandBlaster™ Clean-n-Strip Discs

Part Number	Grit	Size	Quantity/Case
051111- 54767	Medium	4.5"	10

3M™ SandBlaster™ Surface Conditioning Discs

Assorted grits. 3-pack.

Part Number	Grit	Size	Quantity/Case
051111- 54768	Assorted	4.5"	10

Grinding Discs and Wheels

	Applications				
	Coatings Removal	Weld Removal	Deburring	Blending	Metal Finishing
3M™ Grinding Discs					
3M™ Green Corps™ Fibre Discs	P	P	P	P	P
3M™ Fibre Discs 501C		B	B	B	B
3M™ Type C Discs 381C		G	G	G	G
3M™ Type D Discs 280C		B	B	B	B
3M™ Regalite™ Polycut™ Grit-Lok™ Discs 785C	G				
3M™ Green Corps™ Flexible Grinding Discs		B	B	B	B
3M™ Roloc™ Grinding Discs					
3M™ Green Corps™ Roloc™ Discs	P	P	P	P	P
3M™ Regalite™ Polycut™ Fibre Discs 777F		P	P	P	P
3M™ Cut-Off Wheels					
3M™ Green Corps™ Cut-Off Wheels	P	P	P	P	P
3M™ Regalite™ General Purpose Cut-Off Wheels		P	P	P	P

	Substrates						
	Fiberglass	Mild Steel	Stainless Steel	Aluminum	Bronze	Brass	Wood
3M™ Grinding Discs							
3M™ Green Corps™ Fibre Discs	P	P	P	P	P	P	
3M™ Fibre Discs 501C		B	B	B	B	B	
3M™ Type C Discs 381C	G	G	G	G	G	G	G
3M™ Type D Discs 280C	G						
3M™ Regalite™ Polycut™ Grit-Lok™ Discs 785C		P	P	P	P	P	
3M™ Green Corps™ Flexible Grinding Discs		B	B	B	B	B	
3M™ Roloc™ Grinding Discs							
3M™ Green Corps™ Roloc™ Discs	P	P	P	P	P	P	P
3M™ Regalite™ Polycut™ Fibre Discs 777F		P	P	P	P	P	P
3M™ Cut-Off Wheels							
3M™ Green Corps™ Cut-Off Wheels	P	P	P	P	P	P	P
3M™ Regalite™ General Purpose Cut-Off Wheels		P	P	P	P	P	P

P = Preferred Abrasive

B = Better Abrasive

G = Good Abrasive

3M Grinding Discs

3M Grinding Discs are used for metal and coatings removal, weld and fiberglass grinding and blending, heavy-duty deburring and metal finishing. They can also be used on wood. They are used with 3M™ Disc Pad Hubs, 3M™ Disc Pad Face Plates and 3M™ Disc Retainer Nuts. **BE SURE TO READ ALL WARNINGS SUPPLIED WITH DISCS.**

3M™ Green Corps™ Fibre Discs

3M's preferred grinding discs are all-purpose for any kind of fiberglass or metal grinding. These high performance green grinding discs are long-lasting and fast cutting for a whole new performance level in fiberglass and metal grinding. Excellent for boat propeller reconditioning.



Part Number	Grade	Discs/Box	Boxes/Case
5" x 7/8"			
051131- 01913	50	20	5
051131- 01914	36	20	5
051131- 01915	24	20	5
7" x 7/8"			
051131- 01921	50	20	5
051131- 01922	36	20	5
051144- 01923	24	20	5
9-1/8" x 7/8"			
051131- 01927	50	20	5
051131- 01928	36	20	5
051144- 01929	24	20	5

3M™ Fibre Discs 501C

Features tough, sharp alumina zirconia (AZ) mineral. Versatile enough to work on a wide variety of metals. Fast cutting, long-lasting and cool running for weld grinding and blending, metal and coatings removal, heavy duty deburring metal finishing.

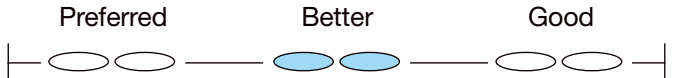

Part Number	Product ID	Grade	Discs/Box	Boxes/Case
4-1/2" x 7/8"				
051111- 50409	501C	24	25	100
051111- 50413	501C	36	25	100
051111- 50414	501C	50	25	100
051111- 50415	501C	60	25	100
051111- 50416	501C	80	25	100
051111- 50417	501C	100	25	100
051111- 50419	501C	120	25	100
5" x 7/8"				
051111- 50410	501C	24	25	100
051111- 50412	501C	36	25	100
051111- 50420	501C	50	25	100
051111- 50421	501C	60	25	100
051111- 50422	501C	80	25	100
051111- 50423	501C	100	25	100
051111- 50424	501C	120	25	100
7" x 7/8"				
051111- 50411	501C	24	25	100
051111- 50426	501C	36	25	100
051111- 50425	501C	50	25	100
051111- 50427	501C	60	25	100
051111- 50428	501C	80	25	100
051111- 50429	501C	100	25	100
051111- 50430	501C	120	25	100
9-1/8" x 7/8"				
051111- 50432	501C	24	25	100
051111- 50433	501C	36	25	100
051111- 50434	501C	50	25	100

3M Grinding Discs

3M™ Type C Discs 381C

A closed coat, aluminum oxide fibre backed discs which are tough as well as flexible. For fiberglass, wood and metal sanding.



Part Number	Product ID	Grade	Discs/Box	Boxes/Case
4" x 5/8"				
051144- 01722	381C	80	100	2
051144- 01725	381C	36	100	2
051144- 81368	381C	24	100	2
5" x 7/8"				
051144- 20052	381C	120	100	4
051144- 20053	381C	100	100	4
051144- 20054	381C	80	100	4
051144- 01727	381C	60	100	4
7" x 7/8"				
051144- 01738	381C	120	25	4
051144- 01739	381C	100	25	4
051144- 01740	381C	80	25	4
051144- 81736	381C	50	25	2
9-1/8" x 7/8"				
051144- 01760	381C	120	25	4
051144- 01761	381C	100	25	4

3M™ Type D Discs 280C

Dependable open coated, heavy duty, aluminum oxide, fibre backed discs. Excellent for fiberglass grinding.



Part Number	Product ID	Grade	Discs/Box	Boxes/Case
5" x 7/8"				
051144- 01818	280C	36	25	4
051144- 01819	280C	24	25	4
051144- 01820	280C	16	25	4
7" x 7/8"				
051144- 01833	280C	36	25	4
051144- 01834	280C	24	25	4
051144- 01835	280C	16	25	4
9-1/8" x 7/8"				
051144- 81867	381C	36	25	4
051144- 81868	381C	24	25	4

3M™ Regalite™ Polycut™ Resin Bond Fibre Grit-Lok™ Discs 785C



Utilizes a state-of-the-art attachment system which results in fast and easy disc changing. It also incorporates 3M™ Regalite™ Polycut™ Resin Bond Fibre Grit-Lok™ Discs 785C, a premium performance disc construction, which is ideal for a variety of grinding applications including steel, brass, bronze, aluminum and fiberglass.

Part Number	Product ID	Grade	Discs/Min. Pkg.	Discs/Case
9" x 11"				
051144- 13884	785C	80	25	100
051144- 13885	785C	60	25	100
051144- 13886	785C	50	25	100
051144- 13888	785C	36	25	100
051144- 13889	785C	24	25	100

3M™ Grit-Lok™ Disc Hubs

Provide a quick and simple disc changing of 3M™ Regalite™ Polycut™ Resin Bond Fibre Grit-Lok™ Discs. Simply insert disc into hub, rotate the disc a 1/4 turn clockwise and you're ready for grinding.



Part Number	Description	Each/Case
051144- 11824	2-1/2" diameter hub 5/8" – 11 thread size fits Black & Decker #4247 or #2750, RYOBI #G1150 or G1250, Dynabrade #50378 or #50237, AEG #WS330, WS601, WS750	1

3M™ Roloc™ Grinding Discs

3M™ Roloc™ Grinding Discs are a handy, quick-change system for disc grinding that fits any standard 1/4" drill. Utilizing a quick 1/2 turn on and off the 3M Roloc disc assembly (PNs 05539, 05540 and 05541), this system speeds up disc changing and cuts down time. 3M Roloc discs are color-coded. The grit of any disc can be determined by the color of the plastic holding button: 50 grit-Green; 36 grit-Brown; 24 grit-Black. The 3M Roloc Disc Assembly has a hard rubber backup pad that comes complete with a 2" x 1/4" shaft.

3M™ Green Corps™ Roloc™ Discs 264F

Combines the versatility of the 3M™ Roloc™ Disc System with the premium quality of 3M™ Green Corps™ construction.



Part Number	Product ID	Grade	Discs/Box	Box/Case
2"				
051131- 01396	264F	50	25	10
051131- 01397	264F	36	25	10
051131- 01398	264F	24	25	10
3"				
051131- 01406	264F	50	25	10
051131- 01407	264F	36	25	10
051131- 01408	264F	24	25	10

3M™ Roloc™ Disc Pad Assemblies

Part Number	For Use with Disc Size	MOS	Each/Case
051144- 05539	2"	25,000 RPM	10
051144- 05540	3"	20,000 RPM	10
051131- 05541	4"	12,000 RPM	10

3M™ Regalite™ Polycut™ Roloc™ Discs 777F

Combine the versatility of the 3M™ Roloc™ Disc System with the premium performance of 3M™ Regalite™ Polycut™ construction. Excellent on stainless steel, aluminum and fiberglass.



Part Number	Product ID	Grade	Discs/Box	Box/Case
2"				
051144- 14661	777F	80	50	4
051144- 80512	777F	120	50	4
3"				
051144- 14634	777F	80	50	4
051144- 80513	777F	120	50	4

3M Grinding Disc Accessories

3M™ Disc Pad Hubs and Face Plates are lightweight, have excellent balance and are low profile for better grinding and finishing control. 3M face plates are designed to resist chunking, reduce edge wear and prolong disc life. Full size plates give support to disc's edge and tapered to fit the disc's shape to minimize flare and wild scratches. 3M™ Disc Retainer Nuts are designed to be used with all 3M disc pad hub and face plates, as well as all non-3M fibre disc holders. They come in various thread sizes and have 1/4" diameter holes for use with a spanner wrench. This attachment system can result in long term savings in materials and changeover time. 3M™ Disc Face Plates are color coded by density:

Color	Hardness	Application
Red	Extra Hard	Heavy grinding.
Black	Hard	Heavy metal removal such as large welds, etc.
Gray	Medium	Normal flexibility for general purpose grinding and finishing.
White	Soft	Flexible for finishing operation and contour grinding.

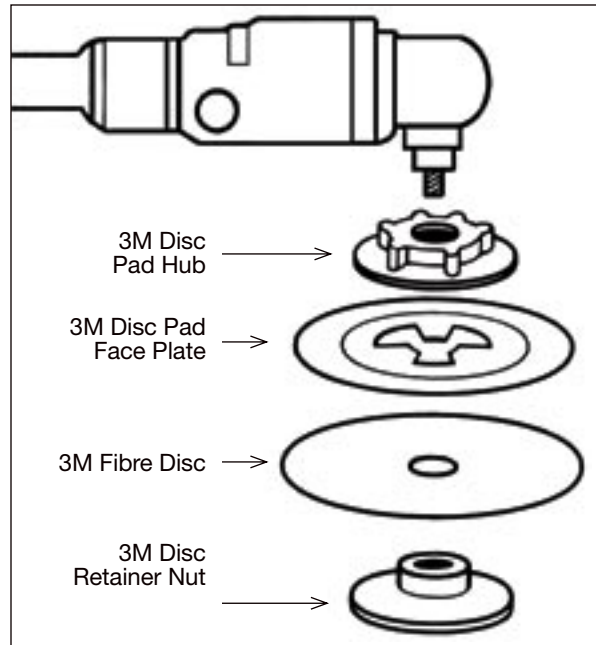

3M™ Disc Pad Face Plates



Part Number	Diameter	Hardness	MOS
051144-14270	4-1/2"	Hard – Black	13,000 RPM
051144-13325	4-1/2"	Medium – Gray	13,000 RPM
051144-45206	5"	Hard – Black	12,000 RPM
051144-45207	5"	Medium – Gray	12,000 RPM
051144-45208	5"	Soft – White	12,000 RPM
051144-45192	7"	Hard – Black	8,500 RPM
051144-45193	7"	Medium – Gray	8,500 RPM
051144-45194	7"	Soft – White	8,500 RPM
051144-45195	9"	Hard – Black	6,500 RPM

3M™ Disc Pad Face Plates – Ribbed



Part Number	Diameter	Hardness	MOS
051144-81732	5"	Extra Hard – Red	12,000 RPM
051144-81733	5"	Hard – Black	12,000 RPM
051144-81734	5"	Medium – Gray	12,000 RPM
051144-81735	5"	Soft – White	12,000 RPM
051144-80514	7"	Extra Hard – Red	8,500 RPM
051144-80515	7"	Hard – Black	8,500 RPM
051144-80516	7"	Medium – Gray	8,500 RPM
051144-80517	7"	Soft – White	8,500 RPM
051144-81728	9"	Extra Hard – Red	6,500 RPM
051144-81729	9"	Hard – Black	6,500 RPM

3M™ Disc Pad HUB

Plastic hubs with 5/8" – 11 metal insert. Use with 3M™ Disc Pad Face Plates.



Part Number	Diameter	Use with	Min./Case
051144-45205	2-1/2"	All size face plates	5/10
051144-45190	4-1/2"	7" face plates only	5/10
051144-88743	2-1/2"	All size face plates, tool shaft length 1/2" or less	5/10

3M™ Disc Retainer Nuts

For use with all 3M™ Disc Pad Face Plates, disc pads, and 3M™ Disc Pad Hubs. Nuts have 5/8" – 11 threaded arbor hole in three depths to accommodate grinder shaft lengths.



Part Number	Depth	Quantity/Case
051144-05622	3/2"	5/10
051144-05621	1/2"	5/10
051144-05620	5/2"	5/10
051111-51047	5-1/16"	5/10

Disc Holder Adapter No. 9

These adapters will convert a grinder with M10 – 1.25, M10 – 1.5, or 3/8" – 24 external threaded shaft to a 5/8" – 11 external threaded shaft.



Part Number	Thread Size	Quantity/Case
040811-22971	M10 – 1.25 INT	10
040811-22972	M10 – 1.55 INT	10
040811-22970	3-3/4" – 24 INT	10

3M™ Cut-Off and Weld Grinding Wheels

These wheels are designed for use in cutting metal, aluminum, stainless steel tubing, propeller shafts, clamps and rusted bolts. They are used with utility type cut-off tools. Maximum Safe Operating Speed (MOS) is 25,000 RPMs. **READ ALL WARNINGS SUPPLIED WITH WHEELS, AND DO NOT USE ON TOOLS WITHOUT GUARDS.**

3M™ Green Corps™ Cut-Off Wheels

High performance and long lasting. Ideal for cutting spot welds and grinding in hard to reach places.



Part Number	Size	MOS	Wheels/ Pack	Packs/ Case
051131- 01989	3" x 1/32" x 3/8"	35,000 RPM	5	10
051131- 01990	3" x 1/16" x 3/8"	28,000 RPM	5	10
051131- 01991	3" x 1/16" x 3/8"	25,000 RPM	5	10
Bulk				
051144- 82238	3" x 1/32" x 1/4"	35,000 RPM	Bulk	50
051131- 01994	4" x 1/32" x 3/8"	25,000	Bulk	50

3M™ General Purpose Cut-Off Wheels

A general purpose, more economical cut-off wheel.



Part Number	Size	MOS	Wheels/Pack
051131- 01987	3" x 1/32" x 3/8"	25,000 RPM	50
051131- 01988	3" x 1/16" x 3/8"	25,000 RPM	50

3M Depressed Center Grinding Wheels

3M™ Green Corps™ Flexible Grinding Discs

These 1/8" thick grinding wheels contain 3M patented Cubitron for fast cut, durability and a consistent finish on all metals. Thinner design gives wheels more flexibility. Smooth operation with minimal vibration. For weld removal and heavy deburring on steel, iron, stainless steel and aluminum. Discs are 1/8" thick with 7/8" shaft. **READ ALL WARNINGS SUPPLIES WITH WHEELS AND DO NOT USE ON TOOLS WITHOUT GUARDS.**



Part Number	Grit	MOS	Each/Box	Boxes/Case
4-1/2"				
051111- 50444	80	13,000 RPM	20	10
051111- 50443	60	13,000 RPM	20	10
051111- 50442	46	13,000 RPM	20	10
051111- 50440	36	13,000 RPM	20	10
7"				
051111- 50448	80	8,500 RPM	20	5
051111- 50447	60	8,500 RPM	20	5
051111- 50446	46	8,500 RPM	20	5
051111- 50445	36	8,500 RPM	20	5

Adapter Nuts

Part Number	Description	Each/Case
051144- 88765	5/8" – 11 Thread	5

3M Disc Holder T-27 Kit

Part Number	Description	Each/Box	Box/Case
051144- 88769	Kit (includes plate, nut, spacers, and wrench)	1	1

Plastic Back-Up Plates

Part Number	For Use with Disc Size	Each/Inner	Each/Case
051111- 51045	7"	5	100
051111- 51046	4-1/2"	5	100

3M™ Green Corps™ Flexible Grinding Wheel Attachment System

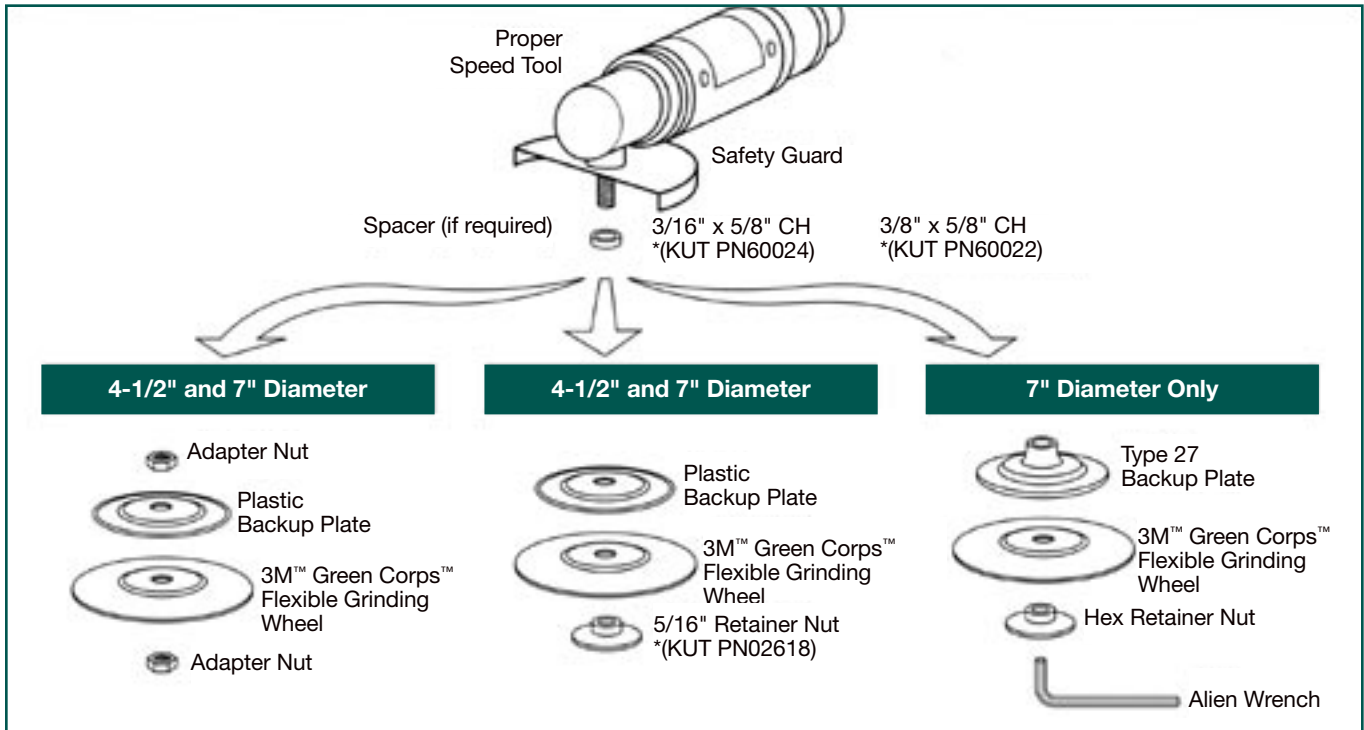

Scotch-Brite™ Applications Chart

	Applications						
	Bottom Paint Stripping	Bottom Paint Scuffing	Varnish Stripping	Rust Removal	Heavy Clean-up	Aluminum Stainless Steel Blending Finishing	Wood Highlighting
Scotch-Brite™ Hand Pads and Sponges							
Heavy Duty – Tan	■	■	■	■	■		
Light Duty – White				■			
Blending – Gray						■	■
General Purpose – Maroon							
Ultra Fine – Gray							
Scrubbing Sponge – No. 74					■		
Flexible Scrubber – No. 85						■	
General Purpose Scouring Pad – No. 96				■	■	■	
General Purpose Scrubbing Pad – No. 9650				■	■	■	
Power Pad – No. 2000						■	
Power Pad Sponge – No. 3000				■	■	■	
Soft Scour™ Sponge – No. 9489							
Multi-Flex Abrasive Sheet Rolls						■	■
Scotch-Brite™ Surface Conditioning Discs							
Coarse – Brown	■	■	■	■	■	■	
Medium – Maroon				■		■	
Very Fine – Blue							
Super Fine – Gray							
General Purpose Scuffing Discs							
Ultra Fine Scuffing Discs							
Scotch-Brite™ RS Coarse	■	■	■	■	■	■	
Scotch-Brite™ RS Medium				■		■	
Scotch-Brite™ Roloc™ Coarse	■	■	■	■	■	■	
Scotch-Brite™ Roloc™ Medium				■			
Scotch-Brite™ Roloc™ Very Fine							
Scotch-Brite™ Roloc™ Super Fine							
3M™ Roloc™ Bristle Products							
Bristle Discs							
Radial Bristle Brushes							
Radial Bristle Discs							

Scotch-Brite™ Applications Chart

	Applications						
	Light Paint Removal	Scuffing Primer/Paint Prep	Metal Cleaning	Deburring	Finishing	General Purpose Multi-Surface Cleaning	Light Multi-Surface Cleaning
Scotch-Brite™ Hand Pads and Sponges							
Heavy Duty – Tan							
Light Duty – White						■	■
Blending – Gray	■						
General Purpose – Maroon		■	■	■			
Ultra Fine – Gray					■		■
Scrubbing Sponge – No. 74						■	■
Flexible Scrubber – No. 85						■	■
General Purpose Scouring Pad – No. 96	■					■	■
General Purpose Scrubbing Pad – No. 9650	■					■	■
Power Pad – No. 2000							
Power Pad Sponge – No. 3000	■		■			■	
Soft Scour™ Sponge – No. 9489						■	■
Multi-Flex Abrasive Sheet Rolls	■	■					
Scotch-Brite™ Surface Conditioning Discs							
Coarse – Brown			■				
Medium – Maroon		■					
Very Fine – Blue					■		■
Super Fine – Gray					■		■
General Purpose Scuffing Discs		■					
Ultra Fine Scuffing Discs							
Scotch-Brite™ RS Coarse			■				
Scotch-Brite™ RS Medium		■					
Scotch-Brite™ Roloc™ Coarse			■				
Scotch-Brite™ Roloc™ Medium							
Scotch-Brite™ Roloc™ Very Fine							
Scotch-Brite™ Roloc™ Super Fine							
3M™ Roloc™ Bristle Products							
Bristle Discs			■	■	■	■	■
Radial Bristle Brushes			■	■	■	■	■
Radial Bristle Discs			■	■	■	■	■

Scotch-Brite™ Hand Pads

Scotch-Brite™ Hand Pads are non-woven, three-dimensional pads that can be used in a variety of blending, finishing and cleaning applications. The convenient size and conformability makes hard to reach and contoured surfaces easily accessible. Their open web construction allows the pads to be easily cleaned, and they can be rinsed for reuse over and over. These pads deliver a uniform, consistent finish because they resist loading and build-up that affects standard coated abrasives. They come in various colors and degrees of coarseness. They can be used to replace steel wool and wire screens, and the finer pads won't scratch most surfaces.



Part Number	Description	Color	Pads/Box	Boxes/Case
6" x 9"				
7440	Heavy Duty	Tan	10	4
051131- 07445	Light Duty	White	20	3
7446	Blending	Gray	10	4
051131- 07447	General Purpose	Maroon	20	2
051131- 07448	Ultra Fine	Gray	20	2

Scotch-Brite™ General Purpose and Ultra Fine Scuff Sponges



Three-dimensional non-woven material laminated to a cellulose sponge material. These sponges are ideal for scuffing/cleaning a variety of marine surfaces. Sponges may be used wet or dry. Hand-held size offers convenience, comfort and reduces waste. Produces the same finish as the PN07447 (Maroon) and PN07448 (Gray) Scotch-Brite™ Hand Pads.

Part Number	Description	Color	Sponges/Bag	Sponges/Case
6" x 9"				
051131- 07441	General Purpose	Maroon	10	30
051131- 07442	Ultra Fine	Gray	10	30
051131- 07439	Clean and Prep	White	10	30

Scotch-Brite™ Cleansing Sponge — No. 63

This convenient two-sided light cleansing tool is ideal for use on stainless steel, plexiglass and plastic surfaces. It won't scratch most surfaces. Scotch-Brite™ side for cleansing action backed by an absorbent cellulose sponge on the other side for wiping spills.



Part Number	Size	Sponges/Case
048011- 08251	5-5/8" x 3-1/2"	20

Scotch-Brite™ Scrubbing Sponge — No. 74

Here's a dual-action cleaning tool for dirty surfaces. It's a scouring pad on one side – scrubs and cleans walls, tables and countertops. The cellulose sponge on the other side quickly wipes up spills and messes. Handy and versatile.



Part Number	Size	Sponges/Case
048011- 20688	6-1/4" x 3-1/2"	20

Scotch-Brite™ General Purpose Scouring Pad — No. 96

It's the original nylon scouring pad and a performance pacesetter. It replaces steel wool and metal sponges, and won't leave metal slivers in hands. Long lasting, non-rusting and resilient.

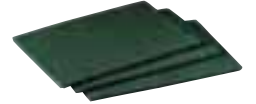

Part Number	Size	Pads/Box	Boxes/Case
048011- 08293	6" x 9"	20	3

Scotch-Brite™ General Purpose Scrubbing Pad — No. 9650

Thicker, hand-size version of Scotch-Brite™ General Purpose Scour Pad No. 96. The convenient size eliminates the need to cut or fold the pad.



Part Number	Size	Pads/Case
048011- 15027	3.5" x 5"	60

Scotch-Brite™ Power Pad — No. 2000

Scours up to 4 times faster than conventional products. Scratches surfaces up to 8 times less than other medium/heavy-duty products. Unique bow-tie shape.



Part Number	Size	Pads/Case
048011- 23162	5.5" x 3.9"	20

Scotch-Brite™ Power Pad Sponge — No. 3000

Two cleaning tools in one. Scotch-Brite™ Power Pad combined with a sponge. Scratches surfaces up to 8 times less than other medium duty/heavy duty products.



Part Number	Size	Sponges/Case
048011- 23163	2.8" x 4.5" x 0.6"	20

Scotch-Brite™ Hand Pads

3M™ Soft Scour!™ Sponge — No. 9489

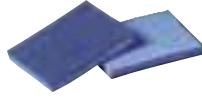

This sponge combines no-scratching scrubbing and moisture pick-up all in one. One side scours and the other side wipes up spills or carries cleaning solution to the work surface.

Part Number	Size	Pads/Bag	Bags/Case
048011- 09489	3-1/2" x 5"	10	4

Scotch-Brite™ Multi-Flex Abrasive Sheet Rolls



Use PN07521 for scuffing before applying paint and paint primers. Also may be used in cleaning upholstery and chrome. A thin, ultra-conformable extra sharp and economical Scotch-Brite™ Sheet. Use for quick scuffing irregular surfaces.

Non-leveling, reusable, use wet or dry. Use PN07522 on the following applications: blending/ finishing of aluminum, wood highlighting and light paint removal. Designed to replace steel wool and wire screens. Extra sharp for fast surface preparation. Non-leveling, reusable, use wet or dry.

Part Number	Grade	Color	Sheets/ Roll	Rolls/ Case
4-1/2"				
051131- 07521	A VFN General Purpose	Maroon/ Purple	60	4
051131- 07522	S-UFN	Light Gray	60	4

Scotch-Brite™ Surface Conditioning Discs

Scotch-Brite™ Surface Conditioning Discs are non-woven, three-dimensional discs that can be used in a variety of blending, finishing and cleaning applications. Their open web construction allows the discs to be easily cleaned for reuse over and over. These discs deliver a uniform, consistent finish because they resist loading and build-up that affects standard coated abrasives. They come in various colors and degrees of coarseness. These discs are designed to be used with Scotch-Brite disc holders, which securely attaches the disc to the through use of the 3M™ Scotchmate™ Dual Lock™ Fastening System. Discs are color coded and come in a variety of coarseness. See chart below. The larger and coarser discs have applications for coating removal and surface preparation of boat hulls. The smaller discs are used in cleaning and surface conditioning of boat propellers, as well as in gasket removal.

Grade	Color	Hardness
Coarse	Brown	80 – 100
Medium	Maroon	100 – 120
Very Fine	Blue	220 – 320
Super Fine	Gray	320 – 600

Scotch-Brite™ Surface Conditioning Discs

Part Number	Grade	Discs/ Box	Boxes/ Case
8"			
040811- 00752	Coarse		20
040811- 00670	Medium		25
040811- 04306	Very Fine		20
7"			
040811- 00751	Coarse		25
040811- 00645	Medium		25
040811- 04305	Very Fine		20
4"			
040811- 07450	Coarse	25	100
040811- 07451	Medium	25	100
051131- 07504	Very Fine	10	25
051131- 07505	Super Fine	10	25
3"			
051131- 07455	Coarse	25	100
051131- 07456	Medium	25	100
051131- 07506	Very Fine	25	4
051131- 07507	Super Fine	25	4
2"			
051131- 07453	Coarse	25	100
051131- 07457	Medium	25	100
051131- 07508	Very Fine	25	4
051131- 07509	Super Fine	25	4

Scotch-Brite™ Surface Conditioning Discs

Scotch-Brite™ Surface Conditioning Disc Pad

This hook-and-loop disc pad connects quickly to any power tool while holding Scotch-Brite™ Surface Conditioning Discs securely and safely through the use of 3M™ Scotchmate™ Dual-Lock™ Fastening System.



Part Number	Size	MOS	Pads/Case
048011- 09451	For 8" Discs	6,000 RPM	1
048011- 09450	For 7" Discs	6,000 RPM	1
048011- 07492	For 4" Discs	13,000 RPM	5
051131- 07493	For 3" Discs	15,000 RPM	10
048011- 07494	For 2" Discs	23,000 RPM	10

3M™ Contact Disc Pad Holder — No. 947

This disc pad holder may be used with 3M™ Surface Conditioning Discs 7" and 8" (PNs 00645, 00670, 00751, and 00752) for use in various scuffing applications. 3M™ Contact Disc Pad Holder No. 947 features a flexible edge which enables the pad to better conform to contours of boat hulls. This disc pad holder fits 5/8" shaft tools.

Part Number	Size	MOS	Pads/Case
051144- 13627	For 7" Discs	6,000 RPM	1

Scotch-Brite™ General Purpose and Ultra-Fine Scuffing Discs

Scotch-Brite™ General Purpose Scuffing Disc (Maroon) and Scotch-Brite ultra-fine scuffing disc (Gray) are designed to be used in conjunction with a 3M™ Hookit™ Disc Pad for 6" discs (PN05776) on a random orbital sander. These discs offer a quicker, more efficient method of machine scuffing marine finishes versus doing it by hand.



Part Number	Grade	Color	Discs/Box	Boxes/Case
6"				
051131- 07467	General Purpose	Maroon	10	4
051131- 07468	Ultra Fine	Gray	10	4

3M™ Hookit™ Disc Pad

This pad is specifically made to use with the 3M™ Hookit™ discs. The pad face securely holds the discs yet allows for easy change and reattachment of discs. The pad is lightweight, shock resistant and well-balanced. The tough durable plastic hub and a conformable foam body are designed for a maximum operating speed of 7000 RPM.



Part Number	Size	MOS	Pads/Case
051131- 05776	6"	12,000 RPM	10

Scotch-Brite™ Surface Conditioning Discs

The unique open web construction of these discs delivers a uniform, consistent finish because it resists the loading and heat buildup that normally affect disc performance; they also work fast and reduce labor and material cost. These discs are designed to be used with the Scotch-Brite™ Disc Holder (PNs 07492-07494 and 09450-09451) and attach safely and securely through the use of the 3M™ Scotchmate™ Dual Lock™ Fastening System. The larger and coarser discs have applications for coating removal and surface preparation of boat hulls. The smaller discs are used in cleaning and surface upgrading of boat propellers, as well as gasket removal. The Coarse grade (brown) equates with a coated abrasive grit of 80 to 100, Medium (maroon) 100 to 120 grit, Very Fine (blue) 220-320, Super Fine (gray) 320-600.

Scotch-Brite™ Roloc™ RS Surface Conditioning Discs

Part Number	Grade	MOS	Discs/Case
2"			
048011- 29211	Coarse	25,000	200
048011- 29212	Medium	25,000	200
3"			
048011- 29213	Coarse	18,000	100
048011- 29214	Medium	18,000	100

Scotch-Brite™ Roloc™ TS Mandrel

Part Number	Each/Case
1/4" x 2"	
051144- 85097	5

Scotch-Brite™ Roloc™ TR Back-Up Pads

Part Number	Grade	MOS	Pads/Case
2"			
051144- 45095	Medium	25,000	5
051144- 45096	Hard	25,000	5
2"			
051144- 45091	Hard	20,000	5

Scotch-Brite™ Hook-and-Loop RS Surface Conditioning Discs

Part Number	Grade	MOS	Per/Case
4-1/2"			
048011- 29217	Coarse	13,000	50
048011- 29218	Medium	13,000	50
5"			
048011- 29219	Coarse	10,000	50
048011- 29220	Medium	10,000	50
7"			
048011- 29221	Coarse	6,000	25
048011- 29222	Medium	6,000	25

Scotch-Brite™ Hook-and-Loop Back-Up Pads



Part Number	Thread Size	MOS	Pads/Case
4-1/2"			
048011- 14111	5/8" - 11 Female Hub Shank	13,000	1
5"			
048011- 05680	5/8" - 11 Female Hub Shank	10,000	1
7"			
048011- 09450	5/8" - 11 Female Hub Shank	6,000	1

Scotch-Brite™ Roloc™ Surface Conditioning Discs

Scotch-Brite™ Roloc™ Surface Conditioning Discs



Part Number	Grade	Discs/Box	Boxes/Case
2"			
051131- 07480	Coarse	25	4
051131- 07481	Medium	25	4
051131- 07515	Very Fine	25	4
051131- 07516	Super Fine	25	4
3"			
051131- 07485	Coarse	25	4
051131- 07486	Medium	25	4
051131- 07513	Very Fine	25	4
051131- 07514	Super Fine	25	4
4"			
051131- 07482	Coarse	10	10
051131- 07483	Medium	10	10
051131- 07511	Very Fine	10	10
051131- 07512	Super Fine	10	10

Scotch-Brite™ Cleaning and Stripping Products

Scotch-Brite™ Clean 'n Strip™ XT Discs

This product earns the 3M Purple color which indicates the latest 3M technology, greatest cost/value and highest quality available. Scotch-Brite™ Clean 'n Strip™ XT Discs have an open web construction for cool running with excellent resistance to loading and smearing. Faster cutting than wire brushes and wheels with no rust or surface contamination from metal residue. These discs are the perfect alternative to wire brushes for removing weld discoloration, scale, rust, paint, coatings, gasket and sealing compounds, adhesives and marine algae.

Part Number	Size	MOS	Discs/Case
048011-27657	4" x 1/4"	6,000 RPM	25
048011-27658	8" x 1/2"	3,000 RPM	15
048011-27659	4" x 1/2"	6,000 RPM	25
048011-27690	6" x 1/2"	4,000 RPM	15

Scotch-Brite™ General Purpose and Ultra Fine Scuffing Wheels Roloc™+

These are constructed of a durable 3D non-woven material. Both products are flexible and ideal for machine scuffing/ cleaning of hard to reach areas. The 3M™ Roloc™+ Holder (PN07500) allows for easy changeover of discs.



Part Number	Size	Wheels/Box	Boxes/Case
051131-07443	4" x 1-1/8" General Purpose	6,000	25

Scotch-Brite™ Clean 'n Strip™ Roloc™+ Discs

Constructed of a 3-D, durable web. These discs are the perfect alternative to wire brushes for removing paint, rust, cleaning welds, drip rail moldings and light grinding/ sanding in hard-to-reach areas. The 3M™ Roloc™+ Holder (PN07500) allows for easy changeover of discs.



Part Number	Size	Discs/Case
051131-07466	4" x 1/2"	10

Scotch-Brite™ Roloc™+ Rivet Cleaning Disc

Constructed of a three dimensional, non-woven material designed to sand and clean around rivets. These discs are aggressive, yet highly conformable. Discs are used in conjunction with 3M™ Roloc™+ Holder (PN07500).



Part Number	Size	Discs/Case
051131-07410	4" x 1-1/4"	10

Scotch-Brite™ Roloc™+ Holder

A durable plastic holder for use with all 3M™ Roloc™+ products including 1/4" steel shank allows easy use to portable tools.



Part Number	Size	Billing Units/Case
051131-07500	1" x 1/4" Shank	1

Stripe Removal Discs

Scotch-Brite™ Large Area Stripe Removal (LASR) Disc Assembly

This is a 8" diameter, 16 layer version of the existing 3M™ Molding Adhesive and Stripe Removal Disc (PNs 07501, 07502). The LASR disc assembly quickly removes vinyl stripes and graphics and their adhesive without damaging gelcoat or marine paint. This assembly is designed to be used with a variable speed buffer with a 1,500–3,000 RPM speed range. Attaching a Scotch-Brite™ LASR Adapter (PN07519) is all that is necessary to convert your 5/8" – 11 shaft to accommodate the LASR Disc Assembly. An approved tool is the Black and Decker Buffmaster #6138.



Part Number	Size	Each/Case
051131-07517	8" Dia. x 5/8"	1

Scotch-Brite™ Roloc™+ Holder

A durable plastic holder for use with all 3M™ Roloc™+ products including 1/4" steel shank allows easy use to portable tools.



Part Number	Size	Billing Units/Case
051131-07500	1" x 1/4" Shank	1

Scotch-Brite™ Molding Adhesive and Stripe Removal Disc Roloc™+

A vinyl, non-abrasive material designed to remove vinyl stripes, numbers, letters and graphics from gelcoat and painted marine surfaces without damaging the finish.

Required 4000 RPM tool.



Part Number	Size	Billing Units/Case
051131-07501	4" x 3/8"	5
051131-07502	6" x 3/8"	5

3M™ Stripe Off Wheel

Use to remove vinyl decals, striping tapes, and double-sided foam attachment tapes. It will not scratch or damage acrylic enamel or urethane paint. Do not use on lacquer coatings. Use with common 3/8" pneumatic and electric tools with a 500 – 4000 RPM speed range. Optimum performance achieved around 200+/-200 RPM.



Part Number	Description	Quantity/Case
051131-07498	Includes attachment hardware	5
051131-07499	Does not include hardware	5

3M™ Bristle Discs and Brushes

3M™ Roloc™ Bristle Discs

A molded abrasive bristle product designed to conform to the workpiece in numerous surface conditioning applications. Much safer to use than conventional wire brushes the discs use the quick "1/2 turn on, 1/2 turn off" 3M™ Roloc™ fastening system for maximum convenience. In addition, the 3M Roloc bristle disc works well in applications where loading is a problem, replacing wire brushes, surface conditioning discs, and coated abrasive discs. The bristle design and 3-dimensional abrasive enable the bristle disc to remove coatings, sealant, and adhesives quickly, leaving a clean surface ready for subsequent operations. The high Maximum Operating Speed (MOS) of the bristle disc makes it compatible with right angle die grinders. Use in conjunction with the 3M Roloc disc pad assembly.



Part Number	Grade	Color	MOS	Discs/Box	Boxes/Case
1"					
048011-18698	50	Green	30,000 RPM	20	80
048011-18706	80	Yellow	30,000 RPM	20	80
048011-18710	120	White	30,000 RPM	20	80
2"					
048011-18730	50	Green	25,000 RPM	10	40
048011-18732	80	Yellow	25,000 RPM	10	40
048011-18733	120	White	25,000 RPM	10	40
3"					
048011-18734	50	Green	18,000 RPM	10	40
048011-18736	80	Yellow	18,000 RPM	10	40
048011-18737	120	White	18,000 RPM	10	40

3M™ Roloc™ Disc Pad Assembly

This disc pad assembly comes complete with a 2" steel shaft and adapter. The hard rubber backup pad provides firm support for Scotch-Brite™ Roloc™ Surface Conditioning Discs (PNs 07480-07514) and 3M™ Roloc™ Bristle Discs (PNs 18698-18737).



Part Number	Size	Hardness	Each/Case
051144-45102	1/4"	Threaded Shaft	50
051144-45101	1"	Medium	5
051144-05539	2"	Coarse	10
051144-05540	3"	Medium	10

3M™ Radial Bristle Brushes

3M™ Radial Bristle Brushes bring superior cleaning to a wide variety of surface areas. The 6" radial bristle brush works on most bench motors in place of wire brushes for general maintenance and production. Tough, flexible products provide a faster cut and more uniform finish.



Part Number	Size	Grade	Color	Brushes/Box	Brushes/Case
048011-27603	6"	36	Dk. Brown	1	5
048011-27605	6"	50	Green	1	5
048011-27606	6"	80	Yellow	1	5

3M™ Bristle Discs and Brushes

3M™ Roloc™ Bristle Disc Introductory Packs

Convenient introductory packs of 2" and 3" as well as assortments of 2" and 3" products including 777F 3M™ Roloc™ Discs, Surface Conditioning and SE Surface Conditioning Discs, Unitized Wheels, Bristle Discs and Disc Pad Holder.



Part Number	Intro Pack No.	Packs/Case
048011-18696	982BS	5
Contains: 2 each 3M™ Roloc™ Bristle Disc, 2" x 5/8" T 50X, 80X, 120X 1 each 3M™ Roloc™ Disc Pad Holder, 2" Hard		
048011-18697	983BS	5
Contains: 2 each 3M™ Roloc™ Bristle Disc, 3" x 5/8" T 50X, 80X, 120X 1 each 3M™ Roloc™ Disc Pad Holder, 3" Hard		
048011-18694	982RS	5
Contains: 3 each 3M 777F 3M™ Roloc™ Disc, 2" – 60YF, 80YF, 120YF 2 each 3M™ Roloc™ Surface Conditioning Disc, 2" – ACRS, AMED, AVFN, SSFN 2 each 3M™ Roloc™ SE Surface Conditioning Disc, 2" – ACRS 1 each 3M™ Roloc™ EXL Unitized Wheels, 2" – 2SFIN, 6AMED, 8ACRS 2 each 3M™ Roloc™ Bristle Disc, 2" x 5/8" T – 50X, 80X, 120X 1 each 3M™ Roloc™ Disc Pad Holder, 2" Hard		
048011-18695	983RS	5
Contains: 3 each 3M 777F 3M™ Roloc™ Disc, 3" – 60YF, 80YF, 120YF 2 each 3M™ Roloc™ Surface Conditioning Disc, 3" – ACRS, AMED, AVFN, SSFN 2 each 3M™ Roloc™ SE Surface Conditioning Disc, 3" – ACRS 1 each 3M™ Roloc™ EXL Unitized Wheels, 3" – 2SFIN, 6AMED, 8ACRS 2 each 3M™ Roloc™ Bristle Disc, 3" x 5/8" T – 50X, 80X, 120X 1 each 3M™ Roloc™ Disc Pad Holder, 3" Hard		

3M™ Radial Bristle Discs

1" and 9/16" are meant for very small jobs. The 9/16" is specifically for polishing in small, tight places where a mirror-like finish is desired. They are very flexible for deburring, cleaning, and/or finishing intricate or tiny areas. The 1" disc is for small areas with heavy duty requirements. Can be used to clean machine marks on soft and hard metals for precision parts or hard-to-reach areas. Satin finish for watch cases and other small metal products. With these discs, you can automate many previous manual operations, and replace chemicals. Use with Mandrels listed below.

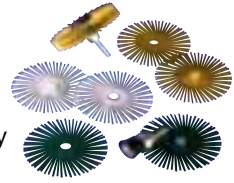

Part Number	Grade	Color	Discs/Box	Boxes/Case
1"				
048011-27610	36	Dk. Brown	24	96
048011-27611	50	Green	24	96
048011-27612	80	Yellow	24	96
048011-27613	120	White	24	96
9/16"				
048011-27614	120	White	48	192
048011-27615	P220	Red	48	192
048011-27616	P400	Blue	48	192
048011-27617	Pumice	Pink	48	192
048011-27618	Polish I	Lt. Green	48	192
048011-27619	Polish II	Peach	48	192

Mandrels

Part Number	Size	MOS	Brushes/Case
048011-27681	1/8" x 1/8"	30,000 RPM	100
048011-27684	1/4" x 1/8"	30,000 RPM	100

3M Fillers and Putties

	Professional Repair					
	Bottom Repair Larger Areas	Bottom Repair Semi-Structural	Bottom Repair Minor Defects	Bottom Repair Bonding	Bottom Repair Filling	Bottom Repair Fairing
3M Fillers						
3M™ Marine High Strength Repair Filler	P	P		P	P	
3M™ Marine Premium Filler			P		P	P
3M™ Zebra™ Advance Lightweight Filler						
3M™ Lightweight Body Filler						
3M™ Long Strand Fiberglass Reinforced Filler						B
3M™ Short Strand Fiberglass Reinforced Filler						
	Topside Repair Larger Areas	Topside Repair Semi-Structural	Topside Repair Minor Defects	Topside Repair Bonding	Topside Repair Filling	Topside Repair Fairing
3M Fillers						
3M™ Marine High Strength Repair Filler	P	P		P	P	
3M™ Marine Premium Filler			P		P	P
3M™ Zebra™ Advance Lightweight Filler			P		P	P
3M™ Lightweight Body Filler			G		G	G
3M™ Long Strand Fiberglass Reinforced Filler	B	B			B	
3M™ Short Strand Fiberglass Reinforced Filler			B		B	B
	Fill Pinholes	Fill Sand Scratches	Fill Minor Scratches	Fill Low Areas	Misc. Imperfections	Grinding Imperfections
3M Putties						
3M™ Piranah™ Advanced Finishing Putty	P	P	P	P	P	
3M™ Acrylic – Green Spot Putty			B		B	
3M™ Acrylic – Blue Glazing Putty		B		B		
3M™ Acrylic – Red Putty	B	B	B			
3M™ Acrylic – Marine Putty – White	B	B			B	B

P = Preferred Abrasive B = Better Abrasive G = Good Abrasive

3M Vinyl Ester Fiberglass Repair Fillers

3M™ Marine High Strength Repair Filler

A unique vinyl ester formulation designed with short strand fiberglass for semistructural repairs, above and below the waterline. This high performance reinforced filler is designed to repair areas of fiberglass hulls, decks, and other parts. Cures tack-free in 30 minutes. Use with 3M™ Blue Crème Hardener (PN05766).

**ABOVE
BELOW**
THE WATERLINE



3M™ Marine Premium Filler

A unique vinyl ester formulation designed for marine filling and fairing applications above and below the waterline. Cures tack-free in 30 minutes. Made with 3M™ Scotchlite™ Glass Bubbles for sanding ease. Use with 3M™ Blue Crème Hardener (PN05766).

**ABOVE
BELOW**
THE WATERLINE



Part Number	Container Size	Containers/Case
051131-46012	1 Pint	6
051131-46013	1 Quart	6
051131-46014	1 Gallon	4

Part Number	Container Size	Containers/Case
051131-46004	1 Pint	6
051131-46005	1 Quart	6
051131-46006	1 Gallon	4

3M Polyester Fiberglass Repair Fillers

3M™ Zebra™ Advanced Lightweight Filler

An advanced formulation, two-component filler designed to fill low areas on hulls, decks above the waterline, as well as other fiberglass, steel, SMC or aluminum parts. Sands better than traditional lightweight fillers with reduced sandpaper loading. Stain-resistant. Vacuum processed for fewer pinholes. Cures tack free in approximately 20 minutes. Use with 3M™ Blue Crème Hardener (PN05766).



Part Number	Container Size	Containers/Case
051131-05868	1 Gallon	4
051131-05870	3 Gallon Pail*	1
051131-05871	5 Gallon Pail**	1

* To be used with Mechanical Dispensers
 ** To be used with Air-Operated Dispensers.

3M™ Lightweight Body Filler

This vacuum processed lightweight body filler is designed to be used for filling and shaping prototypes and plugs in the OEM Plug/Mold Department. This filler cures tack-free in 15–20 minutes, reducing sandpaper loading. Features creamy texture, smooth spreading and easy sanding with reduced sandpaper loading. Use with red 3M™ Crème Hardener (PN05830).



Part Number	Container Size	Containers/Case
051131-05800	1 Quart	6
051131-05801	1 Gallon	4
051131-05804	5 Gallon Pail**	1
051131-05805	5 Gallon Pail*	1

* To be used with Mechanical Dispensers
 ** To be used with Air-Operated Dispensers.

3M™ Long Strand Fiberglass Reinforced Filler

This polyester filler contains long strands of fiberglass and is designed to repair larger holes, cracks and tears in fiberglass above the waterline. Also repairs holes in metal. Waterproof. Use with red 3M™ Crème Hardener (PN05830).



Preferred Better Good

Part Number	Container Size	Containers/Case
051131-05814	1 Gallon 10.5 lbs./168 oz.	4

3M™ Short Strand Fiberglass Reinforced Filler

This polyester filler contains chopped fiberglass and is designed to repair smaller holes, cracks and tears in fiberglass above the waterline. Also repairs holes in metal. Smooth spreading and waterproof. Can be used with 3M™ Fiberglass Mat (PN05837) or 3M™ Fiberglass Cloth (PN05838) to reinforce large repair areas. Use with red 3M™ Crème Hardener (PN05830).



Preferred Better Good

Part Number	Container Size	Containers/Case
051131-05815	1 Gallon	4
051131-05816	1 Quart	6

3M™ Fiberglass Repair Putties

3M™ Piranah™ Advanced Finishing Putty



This two-component, self-leveling putty is designed for use as a skin coat over fillers to fill pinholes, sand scratches, low areas and other imperfections. It grips tightly to fiberglass, sanded paint, steel aluminum and SMC. Flowable and brushable, it cures tack-free in 30 minutes. Extremely easy sanding. Non-staining.

Part Number	Container Size	Containers/Case
051131-05821	24 fl. oz. Tube	6

3M™ Acryl-Red Putty



Spreads and sands easily, dries fast, has minimum shrinkage and excellent adhesion. It loads paper less and feathers out to a smooth surface. This putty is recommended for filling pinholes, scratches and grinding imperfections.

Part Number	Color	Container Size	Containers/Case
051144-05966	Red	21 oz. Tube	12

3M™ Acryl-Green Spot Putty



Spreads and sands easily, dries fast, has minimum shrinkage and excellent adhesion. This spot putty is recommended for filling minor imperfections and scratches.

Part Number	Color	Container Size	Containers/Case
051144-05960	Green	21 oz. Tube	12

3M™ Acryl-Marine Putty – White



Designed specifically for the boat repair market, this putty is recommended for filling pinholes, scratches and other surface defects on hulls. Its white color minimizes the possibility of color showing through the final coat as can happen when using colored putties beneath white paint. Other advantages include easy sanding, fast drying, spreads easily, and has low shrinkage.

Part Number	Color	Container Size	Containers/Case
051131-05962	White	21 oz. Tube	12

3M™ Acryl-Blue Glazing Putty



Spreads and sands easily, dries fast, has minimum shrinkage and excellent adhesion. This glazing putty is recommended for filling minor low areas or deeper sand scratches.

Part Number	Color	Container Size	Containers/Case
051144-05964	Blue	21 oz. Tube	12

3M Hardeners, Resin and Accessories

3M™ Blue Crème Hardener

A blue crème hardening agent designed to be used with 3M™ Marine High Strength Repair Filler (PN46012), 3M™ Premium Filler, 3M™ Zebra™ Advanced Lightweight Filler (PN05868) and 3M™ Piranah™ Putty (PN05021). Its creamy consistency mixes easily and quickly.

Part Number	Color	Container Size	Containers/Case
051131-05766	Blue	2.75 oz. Tube	12

3M™ Crème Hardener

A red crème hardening agent designed to be used with 3M™ Lightweight Body Filler (PN05800), 3M™ Long Strand Fiberglass Reinforced Filler (PN05014) and 3M™ Short Strand Fiberglass Reinforced Filler (PN05815 and 05816).



Part Number	Color	Container Size	Containers/Case
051131-05830	Red	2.75 oz. Tube	12

3M™ Fiberglass Resin

This polyester resin is designed to be used with 3M™ Fiberglass Cloth (PN05838) or 3M™ Fiberglass Mat (PN05833) to patch cracks, tears, punctures and splits in fiberglass and gelcoat, as well as repair holes in metal. The thick formulation resists sags or runs, and it is waterproof when cured. Comes with 3M™ Liquid Hardener (PN05836).



Part Number	Container Size	Containers/Case
051131-05833	1 Quart	12
051131-05834	1 Quart	12

3M™ Liquid Hardener



051131-05836	22cc Tube	12
--------------	-----------	----

3M™ Fiberglass Mat

For patching cracks, tears, punctures or splits in fiberglass, larger holes in metal, or for large repair areas where more reinforcement is needed. Designed for use with 3M™ Fiberglass Resin (PNs 05833 or 05834) or 3M™ Short Strand Reinforced Fiberglass Filler (PNs 05815 or 05816).



Part Number	Description	Size	Units/Case
051131-05837	Mat	8 Sq. Ft.	6
051131-05838	Cloth	8 Sq. Ft.	6

3M™ Spreaders

Designed for spreading body and fiberglass fillers, finishing putties and resins. These spreaders are flexible, durable and easy to clean. Each has a sharp edge and cured filler pops off easily.



Part Number	Size	Units/Case
051131-05842	4"	50
051131-05844	Assortment 1 each - 4", 5" and 6"	24

3M™ Scotchlite™ Glass Bubbles

Hollow, unicellular, microscopic spheres composed of water, insoluble chemically stable soda-lime borosilicate glass. This filler/resin extender can be used in mixing of marine putties and fairing compounds, as well as in fiberglass reinforced plastic layup. These bubbles offer light-weight, minimal shrinkage and easy sanding. For hand mixing use K1 or K15 series bubbles; for spray applications less than 500 psi use K20 series bubbles; for spray applications less than 750 psi use K25 series bubbles.

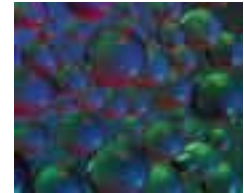

Part Number	Catalog Number	Pounds/Case
021200-67424	K1	5
021200-67432	K1	40
021200-67416	K15	10
021200-86417	K15	50
021200-86422	K20	10
021200-86423	K20	60
021200-83949	K25	10
021200-83950	K25	80

3M Marine “Preferred” Product Systems for Marine Applications

3M “Preferred” Gelcoat Oxidation Removal/Reconditioning System

Heavy Oxidation		Light to Medium Oxidation	
1	3M™ Marine Fiberglass Restorer and Wax Best used with any 3M™ Superbuff™ Compound Pad	1	3M™ Marine Fiberglass Cleaner and Wax Best used with any 3M™ Superbuff™ Compound Pad
<i>For added protection or when follow-up wax is needed</i>			
2	3M™ Marine Ultra Performance Paste Wax Best used with 3M™ High Performance Cloth	2	3M™ Marine Ultra Performance Paste Wax Best used with 3M™ High Performance Cloth
<i>For regular touch-up and maintenance as needed</i>			
3	3M™ Marine Clean and Shine Wax with soft cloth or 3M™ High Performance Cloth	3	3M™ Marine Clean and Shine Wax with soft cloth or 3M™ High Performance Cloth

3M Marine Surface Maintenance Products – Restoring Products

3M™ Marine Restorer and Wax



Special blend of rubbing compound and a variety of waxes produces a high gloss while removing medium to heavy oxidation, chalking, water spots, rust and exhaust stains in one step. Ideal for fiberglass/gelcoat and marine topside paints. Retards UV light damage.

Part Number	Container Size	Containers/Case
051131-09005	16 fl. oz. (Liquid)	6
051131-09006	32 fl. oz. (Liquid)	6
051131-09007	1 Gallon (Liquid)	2

3M™ Super Duty Rubbing Compound

Fast-cutting, liquid rubbing compound clings to surfaces to remove scratches and heavy oxidation on fiberglass/gelcoat and painted surfaces. Can be used by hand or machine. Follow-up with 3M™ Marine Finesse-It™ II Glaze for a deep “wet look” shine.



Part Number	Container Size	Containers/Case
051131-09004	16 fl. oz.	6
051131-05954	1 Quart	12
051131-05955	1 Gallon	4

3M™ Marine Finesse-It™ II Glaze

Designed to remove swirl marks, minor scratches and light oxidation while producing a “wet look” finish on fiberglass/gelcoat and painted surfaces. Contains no wax or silicone.



Part Number	Container Size	Containers/Case
051131-09048	1 Pint	6
051131-05928	1 Quart	12
051131-05929	1 Gallon	4

3M™ Marine Color/Gloss Restorer



Resurrect the gloss in gelcoat with this compound/polish that combines an exceptionally fast cutting compound with a finishing material in one. Removes light to heavy oxidation, scratches, stains, blemishes, and fine swirl marks. Contains no wax or silicone. Use by hand or with an electric air powered machine. Follow-up with a Scotchgard™ Marine Wax or 3M™ Marine Wax to maintain the gloss.

Part Number	Container Size	Containers/Case
051131-09089	500ml Spray	6

3M™ Marine Metal Restorer and Polish



Unique combination of rubbing compounds and oils that polishes and restored original luster. Quickly removes surface rust, oxidation, corrosion and tarnish in one step. Safe to use on stainless steel, brass, bronze, copper, chrome and other marine metals.

Part Number	Container Size	Containers/Case
051131-09019	Net wt. 18 oz. (Paste)	12

3M™ Marine Aluminum Restorer and Polish

Designed to restore the original lustre on bare of painted aluminum surfaces. Removes oxidation, chalking, water spots and other weathering effects, in one step. Use on non-anodized aluminum only.



Part Number	Container Size	Containers/Case
051131-09020	Net wt. 18 oz. (Paste)	6

3M™ Marine Superbuff™ Pad

Two-sided, 6" diameter buffing is designed fore 1/4" or 3/8" drills for compounding, waxing or polishing your boat. Has a built-in backup pad to assure balance and non-slip, vibration-free operation. Allows full-surface contact with fewer swirl marks.



Part Number	Pads/Case
051131-09038	12

3M Marine Surface Maintenance Products – Cleaning Products

3M™ Marine Fiberglass Cleaner and Wax

Special blend of light rubbing compound combined with a variety of waxes. Designed to clean and protect lightly oxidized fiberglass/gelcoat and marine topside paints, in one easy step.

One Step Process



Part Number	Container Size	Containers/Case
051131-09009	16 fl. oz. (Liquid)	6
051131-09010	32 fl. oz. (Liquid)	6
051131-09011	1 Gallon (Liquid)	2

3M™ Marine Multi-Purpose Boat Soap

Concentrated formula cleans a variety of surfaces removing grease, oil, grime, algae, fish blood and dirt. Excellent on hull, deck, upholstery, canvas, carpet, windows and engines.



Part Number	Container Size	Containers/Case
051131-09034	16 oz. (Liquid)	6
051131-09035	32 oz. (Liquid)	6

3M™ Marine Boat Wash

With an easy-to-use attachment system, this formula removes algae, grime, oil, fish blood and dirt from fiberglass/gelcoat, metal and painted surface.



Part Number	Container Size	Containers/Case
051131-09060	32 oz.	12

3M™ Marine Non-Skid Deck Cleaner

3M-patented formula that deep cleans ground in dirt and stains on non-skid areas. Ideal for fiberglass/gelcoat, metal and painted surfaces.



Part Number	Container Size	Containers/Case
051131-09063	1 Liter	6

3M™ Marine Vinyl Cleaner and Restorer

Cleans, shines and conditions while deep cleaning dirt and grime from vinyl, rubber and plastic surfaces, in one easy step. Leaves a fresh lemon scent.

One Step Process



Part Number	Container Size	Containers/Case
051131-09029	15 fl. oz.	6

3M™ Marine Black Streak Remover

Formulated to safely remove black streaks and other stains with an easy spray-on formula. Ideal for fiberglass/gelcoat, metal and painted surfaces.



Part Number	Container Size	Containers/Case
051131-09047	500ml Spray	6

3M™ Marine Mildew Stain Remover

Unique spray-and-wipe formula quickly removes mildew stains and dirt from vinyl, boat covers, cushions, carpets/fabrics and other marine surfaces. Follow up with 3M™ Marine Mildew Block for lasting protection.



Part Number	Container Size	Containers/Case
051131-09067	500ml Spray	6

3M™ Detailing Spray Bottle and Nozzle

A 32 oz. fluorinated bottle. Use with 3M™ Detailing General Purpose Spray Trigger Nozzle Head (PN37717) for water-based products. Use with 3M™ Solvent Spray Trigger Nozzle Head (PN37718) for solvent-based products.



Part Number	Container Size	Containers/Case
051131-37716	32 oz. Spray	24
051131-37717	Spray Trigger Nozzle Head – Water-Based	24
051131-37718	Spray Trigger Nozzle Head – Solvent-Based	24

3M Marine Surface Maintenance Products – Protecting Products

Scotchgard™ Marine Liquid Wax

Results that combine exceptionally high gloss and unmatched durability that lasts and lasts. The unique formula provides protection from the sun's damaging ultraviolet rays, and is safe for use on fiberglass/gelcoat, marine topside paints, painted aluminum and marine metal parts. Reactive chemistry actually bonds the wax to your boat's surface. Contains a pleasant tropical scent.



Part Number	Container Size	Containers/Case
051131-09061	500ml Spray	6
051131-09062	1 Liter	6

3M™ Marine Liquid Wax

Formula designed to provide exceptional gloss and durable protection to fiberglass/gelcoat, marine topside paint and marine trim metals. A special formulation that uses reactive chemistry to bond the boats surface, providing exceptional durability. Retards UV rays.



Part Number	Container Size	Containers/Case
051131-09026	16 fl. oz. (Liquid)	6
051131-09027	32 fl. oz. (Liquid)	6

3M™ Marine Vinyl Conditioner and Protector

Designed to clean, condition and protect marine vinyl and rubber components. Unique gel formula provides durable protection in exterior, as well as interior applications. Gel formula gives you better application control than liquids. A little bit goes a long way.

One Step Process



Part Number	Container Size	Containers/Case
051131-09023	8 oz. (Gel)	6

3M™ Marine Ultra Performance Paste Wax

Unique, concentrated formula contains carnauba and other waxes. Provides a durable, high gloss finish on fiberglass/gelcoat, metal and painted surfaces. Protects against UV rays.



Part Number	Container Size	Containers/Case
051131-09030	9.5 oz. Tub	6

3M™ Marine Clean and Shine Wax

One Step Process

Spray on/wipe off formula cleans and shines while providing a "just waxed" look. Ideal for fiberglass topside paint, painted aluminum and other metal surfaces. Quick and easy to apply in one easy step. Use on both wet and dry surfaces.



Part Number	Container Size	Containers/Case
051131-09033	15 oz.	6









3M™ Marine Mildew Block

Patented, non-toxic formula helps keep surface cleaner with an invisible barrier that blocks mildew growth. Safe to use on most marine surfaces and wherever mildew grows. Ideal for vinyl seats, cushions, sails, covers, furniture, plastic, tile, grout, sealed, wood, metal, nylon and fiberglass.



Part Number	Container Size	Containers/Case
051131-09065	500ml Spray	6

3M Marine “Preferred” Finishing

	Compound	Buff Pad	Glaze	Buff Pad
Tooling Gelcoat	3M™ Marine Imperial Compound and Finishing Material 	3M™ Superbuff™ III (double-sided) or	3M™ Perfect-It™ 3000 Swirl Mark Remover followed by 3M™ Perfect-It™ 3000 Final Glaze 	3M™ Superbuff™ (double-sided) or
Production Gelcoat	3M™ Marine Imperial Compound and Finishing Material 	3M™ Perfect-It™ III (single-sided) 	3M™ Finesse-It™ II Finishing Material 	3M™ Hookit™ SBS™ (single-sided) 
Paint*	3M™ Perfect-It™ III 3000 Extra-Cut Rubbing Compound 	White Compound Pad	3M™ Perfect-It™ 3000 Swirl Mark Remover followed by 3M™ Perfect-It™ 3000 Final Glaze 	Yellow Polishing Pad

* Always refer to paint manufacturer's instructions.

3M “Preferred” Gelcoat Finishing Systems

Production Gelcoat	
1	3M™ Imperial™ Hookit™ Abrasives P320 or P400 with Standard Disc Pad
2	3M™ 260L Finishing Film P600, followed by P800, followed by P1000* with Standard Disc Pad and Soft Interface Pad
3	<i>Optional Step: 3M™ 260L Finishing Film P1200</i>
4	3M™ Imperial™ Compound and Finishing Material with any 100% Wool 3M White Compound Pad
5	If necessary, remove swirl marks with 3M™ Imperial™ Compound and finishing material with any 3M Yellow Polishing Pad
6	Clean surface with 3M™ Marine Clean and Shine Wax and Scotch-Brite™ High Performance Cloth

Tooling Gelcoat	
1	Remove debris or mold release agents with 3M™ Sharpshooter Extra Strength No Rinse Cleaner and Scotch-Brite™ High Performance Cloth
2	3M™ Imperial™ Hookit™ P220, followed by P500 with Standard Disc Pad
3	3M™ Imperial™ 360L P800 followed by P1000 with Standard Disc Pad and Soft Interface Pad
4	3M™ Imperial™ Compound and Finishing Material with any 100% Wool 3M White Compound Pad
5	3M™ Perfect-It™ 3000 Swirl Mark Remover with any 3M Yellow Polishing Pad or Black Foam Polishing Pad
6	<i>Optional Step: 3M™ Perfect-It™ 3000 Final Glaze with 3M Black Foam Polishing Pad</i>

* End users may feel they can eliminate sanding steps, which is fine.

3M “Preferred” Topside Paint Finishing Systems*

Surface Texture Repair (Orange, Peel, Dust Nibs, etc.)	
1	Apply 3M Dry Guide Coat as a sanding aid. Remove Guide Coat with 3M™ 260L Hookit™ Finishing Film P1000 with Low Profile Finishing Disc Pad.
2	Reapply Guide Coat and remove with 3M™ 260L Hookit™ Finishing Film P1200 or P1500 with Low Profile Finishing Disc Pad and Soft Interface Pad.
3	3M™ Perfect-It™ 3000 Extra Cut Compound with any 3M White 100% Wool Compounding Pad.
4	3M™ Perfect-It™ 3000 Swirl Mark Remover with 3M Yellow Polishing Pad
5	<i>Optional Step: 3M™ Perfect-It™ 3000 Finishing Glaze or 3M™ Detail Polish 208 with 3M™ Perfect-It™ Black Foam Polishing Pad or by hand with Scotch-Brite™ High Performance Cloth.</i>

Sag or Run Repair	
1	3M™ Imperial™ WeterDry™ 401Q Ultra Fine 1000 Paper with Rigid Hand Block
2	3M™ Imperial™ WeterDry™ 401Q Microfine 1200 Paper with Rigid Hand Block
3	<i>Optional Step: 3M™ Imperial™ Wet-or-Dry™ 401Q Microfine 2000 or Microfine 2500 Paper with Rigid Hand Block</i>
4	3M™ Perfect-It™ 3000 Extra Cut Compound with any 3M White 100% Wool Compounding Pad.
5	3M™ Perfect-It™ 3000 Swirl Mark Remover with 3M Yellow Polishing Pad.
6	<i>Optional Step: 3M™ Perfect-It™ 3000 Finishing Glaze or 3M™ Detail Polish with 3M™ Perfect-It™ Black Foam Polishing Pad or by hand with Scotch-Brite™ High Performance Cloth.</i>

* Always follow paint manufacturer's instructions.

3M Marine Gelcoat Finishing Compounds and Glazes

3M™ Super Duty Rubbing Compound

3M's "Good" gelcoat finishing compound. Recommended for heavy aggressive compounding of oxidized gelcoat and marine paint. Clings to paint surface – remains wet on the job with little or no mess. Maintains high rate of cut with constant pressure. Buffs to high gloss with minimum of swirl marks. Can be used by hand or by machine.



Part Number	Container Size	Containers/Case
051131-09004	1 Pint	6
051131-05954	1 Quart	12
051131-05955	1 Gallon	4

3M™ Marine Finesse-It™ II Glaze

3M's "Preferred" glaze is designed for use on gelcoat and marine paints to remove swirl marks after compounding. Also an excellent choice for removing light to medium oxidation. Leaves a glazed finish. Use with an air or electric buffer at 1500 – 2500 RPM with a yellow 3M 100% wool polishing buff pad (PN05705 or 05713). Best results will be achieved by following 3M Marine's Preferred Production or Tooling Gelcoat Finishing Systems sanding and buffing steps (see page 61).



Part Number	Container Size	Containers/Case
051131-09048	1 Pint	6
051131-35928	1 Quart	12
051131-35929	1 Gallon	4

3M™ Detail Polish 208

3M's "Good" polish is a fine finishing polish that is easy to use and effective with foam polishing pads (PN05725 or 05726). Leaves a high-gloss finish on marine coatings. This polish contains silicone.



Part Number	Container Size	Containers/Case
051131-38116	1 Gallon	4

3M™ Marine Premium Mold and Tooling Compound

The premium compound has a unique formulation that aggressively removes P800 or finer sanding scratches on tooling gelcoat, reducing sanding and buffing time and saving money. Contains no wax or silicone. Use with an air or electric buffer at 1500 – 2500 RPM with a yellow 3M 100% wool polishing buff pad (PN05705 or 05713). If necessary, follow with 3M™ Finesse-It™ II Finishing Material (PN35928 or 35929) for a clean, high-gloss finish. Best results will be achieved by following 3M Marine's Preferred Tooling Gelcoat Finishing System sanding and buffing steps (see page 61).



Part Number	Container Size	Containers/Case
051131-06027	1 Gallon	4

3M™ Imperial™ Compound and Finishing Material

3M's Marine "Preferred" gelcoat finishing compound is fast cutting, while leaving an excellent finish with minimal to no swirl marks. This white liquid compound and finishing material is designed to remove a P800 or P1000 dual action sand scratch from gelcoat. Also is an excellent choice for removing heavy oxidation. Use with an air or electric buffer at 1500 – 2500 RPM with a white 3M 100% wool compounding buff pad (PN05703 or 05719). Best results will be achieved by following 3M Marine's Preferred Production Gelcoat Finishing System sanding and buffing steps (see page 61).



Part Number	Container Size	Containers/Case
051131-06044	32. fl. oz.	12
051131-06045	1 Gallon	4
NEW 051131-06046	5 Gallon	1

3M™ Marine High Gloss Gelcoat Compound

3M's Marine "Better" gelcoat finishing compound. This paste compound is designed to quickly remove P800 dual action sand scratches or 1000 wet sanding scratches from production gelcoat. Contains no wax or silicone and leaves a high gloss finish with minimal swirl/wheel marks. It has a unique formulation that reduces slinging while buffing. Best results are obtained when used with a white 3M 100% wool compounding pad (PN05703 or 05719) on a slow-speed polisher at 1500 – 2500 RPM. If necessary, follow with 3M™ Finesse-It™ II Finishing Material (PN35928 or 35929) for a clean, high-gloss finish.



Part Number	Container Size	Containers/Case
051131-06025	1 Gallon – 10 lbs.	4
051131-06026	5 Gallon – 50 lbs.	1

3M Buff Pad Accessories

3M™ Superbuff™ Adapter

Adapter used to secure double-sided 3M buff pads to buffer, as well as with 3M™ Perfect-It™ Backup Pad (PN05718).



Part Number	Pads/Case
051144- 05710	10

3M™ Hookit™ SBS™ Back-Up Pad

Back-up pad used with 3M™ Hookit™ SBS™ single-sided polishing pad (PN05713).



Part Number	Pads/Case
051131- 05717	4

3M™ Perfect-It™ Backup Pad

A specially designed backup pad for use with the 3M™ Superbuff™ Adapter (PN05710). This backup pad enables 3M™ Superbuff™ Pad users to use the 3M™ Perfect-It™ Foam Polishing Pad without having to remove the 3M Superbuff adapter from the shaft of the polisher. Fits all standard (5/8" shaft) slow-speed polishers.



Part Number	Pads/Case
051131- 05718	1

3M™ Finesse-It™ Roloc™ Finishing Pad

Holds the 3" 3M™ Finesse-It™ Natural Buffing Pad in place. Provides a soft surface for excellent results. Finishing pad mounts in a 3" 3M™ Roloc™ Disc Pad Assembly (PN05540).



Part Number	Size	Pads/Bag	Bags/Case
051144- 14736	3"	12	12

Scotch-Brite™ High Performance Cloth

Provides ultra cleaning power because of its knitted, interwoven design of water-and oil-absorbing microfibers that lift and trap liquids, grease, dust and dirt particles. Surfaces are left cleaner than with conventional wipes. When used dry or damp, it's excellent for the removal of grease and silicone from injection molded parts, solvents, dust residue, abrasive residue, splatter from welding, compounds, polish residues, waxes and fingerprints.



Part Number	Color	Size	Cloths/Case
048011- 23589	Blue	32cm x 36cm	50
048011- 23649	White	32cm x 36cm	50
048011- 23650	Green	32cm x 36cm	50
048011- 23651	Yellow	32cm x 36cm	50
048011- 23652	Red	32cm x 36cm	50

Part Number	Color	Size	Cloths/Case	Packs/Case
048011- 25972	Blue	32cm x 36cm	3	10
048011- 25942	Blue	32cm x 36cm	5	10
Retail Package				
051131- 67408	Blue	32cm x 36cm	1	12

3M™ Perfect-It™ Detailing Cloths

These cloths are safe, chemical-free, streak-free and non-linting. Microfiber design quickly and easily removes oily and filmy residues. They can be used damp or dry on paint, metal, glass and other marine substrates. The cloths are washable, reusable and durable. Available in two sizes.



Part Number	Size	Cloths/Pack	Packs/Case
051131- 06016	12.5" x 14"	6	6
051131- 06017	12.5" x 14"	50	1
051131- 06018	16" x 16"	6	6

3M Marine Paint Finishing Compounds and Glazes*

3M™ Perfect-It™ 3000 Extra-Cut Rubbing Compound

3M's "Preferred" paint finishing compound.* Designed to remove P1200 and finer sand scratches when used with a white 3M 100% wool compounding pad (PN05703 or 05719), or P1500 and finer sand scratches with a black foam polishing pad (PN05725 or 05726). Completely removes scratches without filling. Easy to detail. Works on fresh or cured paint* surfaces, and its non-gritty formula produces a fine swirl mark finish. Use with an air or electric buffer at 1500 – 2500 RPM with a white 3M 100% wool compounding buff pad (PN05703 or 05719). Best results will be achieved by following 3M Marine's Preferred Paint Finishing System* sanding and buffing steps (see page 61).



Part Number	Container Size	Containers/Case
051131-06060	1 Quart	6
051131-06061	1 Gallon	4

3M™ Perfect-It™ 3000 Rubbing Compound

3M's "Preferred" paint finishing compound.* Lighter than 3M™ Perfect-It™ 3000 Extra Cut Rubbing Compound, this product is designed to remove P1500 and finer sand scratches with a black foam polishing pad (PN05725 or 05726). Completely removes scratches without filling. Easy to detail. Works on fresh or cured paint* surfaces, and its non-gritty formula produces a fine swirl mark finish.



Part Number	Container Size	Containers/Case
051131-06062	1 Quart	6
051131-06063	1 Gallon	4

3M™ Perfect-It™ 3000 Swirl Mark Remover

3M's "Preferred" paint finishing glaze.* Designed as the first follow-up step to 3M™ Perfect-It™ 3000 Extra Cut Rubbing Compound, this product will quickly and effectively remove swirl marks from paint surfaces. Good handling with easy clean-up. Use with an air or electric buffer at 1500 – 2500 RPM with a yellow 3M 100% polishing buff pad (PN05705 or 05713). Best results will be achieved by following 3M Marine's Preferred Paint Finishing System* sanding and buffing steps (see page 61).



Part Number	Container Size	Containers/Case
051131-06064	1 Quart	6
051131-06065	1 Gallon	4

3M™ Perfect-It™ 3000 Final Glaze

3M's "Preferred" paint finishing glaze.* Designed as the follow-up step to 3M™ Perfect-It™ 3000 Swirl Mark Remover. Produces a durable, high-gloss finish on fresh or cured paint surfaces.* Good handling with easy clean-up. Can be applied by hand, or use with an air or electric buffer at 1500 – 2500 RPM with a yellow 3M 100% polishing buff pad (PN05705 or 05713). Best results will be achieved by following 3M's Marine "Preferred" Paint Finishing System* sanding and buffing steps (see page 61).



Part Number	Container Size	Containers/Case
051131-06066	1 Quart	6
051131-06067	1 Gallon	4

3M™ Perfect-It 3000 Spot Finishing Material

Designed to remove the P3000 scratch created by 3M™ Trizact™ Hookit™ II Foam Discs or to quickly and easily remove compound swirl marks. Leaves an excellent, high-gloss finish. Ideal for spot repairs. Good handling with easy clean-up.



Part Number	Container Size	Containers/Case
051131-06070	1 Quart	6

3M™ Trizact™ Hookit™ II Foam Discs

3M™ Trizact™ abrasives feature a pyramid-shaped structure that contains multiple layers of abrasive mineral. Providing a consistently smooth finish, these discs are used to refine finishing film scratches prior to buffing by producing a P3000 scratch. Use of these discs can reduce compounding time. Follow-with 3M™ Perfect-It™ 3000 Spot Finishing Material to remove the scratch. Utilizes the 3M™ Hookit™ II attachment system.



Part Number	Size	Discs/Box	Boxes/Case
051131-02077	3"	15	4
051131-02075	6"	15	4

3M™ Hookit™ II Back-Up Pads

Part Number	Size	Discs/Case
051131-05270	3"	5
051131-05276	6"	10

* Always refer to paint manufacturer's instructions.

Buffing Pad Characteristics

Part Number	Description	
100% Wool Compound Pads		
051131-05703	3M™ Superbuff™ III (P)	
051131-05700	3M™ Superbuff™	
051131-05719	3M™ Perfect-It™ III (P)	
Blended Wool Compound Pads		
051131-05704	3M™ Superbuff™ III 2 Plus 2 (P)	
051131-05701	3M™ Superbuff™ 2 Plus 2	
051131-05734	3M™ Perfect-It™ III Foam Compounding Pad	
Polishing Pads		
051131-05705	3M™ Superbuff™ III (P)	
051131-05713	3M™ Hookit™ SBS™ (P)	
051131-05725	3M™ Perfect-It™ Black	
051131-05726	Foam Polishing Pads (P)	
051144-81470	3M™ Finesse-It™ Natural Buffing	
051144-81471	Pads	

(P) = Preferred Pad

3M Compounding Pads

3M™ Superbuff™ III Buffing Pad

3M's "Preferred" 100% twisted wool compounding pad. Double-sided. An aggressive, fast-cutting pad with a stiffer center hub for more cutting power. Excellent for gelcoat and marine paints*. Fits all standard (5/8" shaft) slow-speed polishers. Use with 3M™ Superbuff™ Adapter (PN05710).



Part Number	Pads/Case
051131-05703	6

* Always refer to paint manufacturer's instructions.

3M™ Superbuff™ III 2 Plus 2 Buffing Pad

3M's "Preferred" 100% blended wool compounding pad. Double-sided. Less aggressive than a 100% wool pad, this pad has a stiffer center hub for more cutting power. Excellent for gelcoat and marine paints*. Fits all standard (5/8" shaft) slow-speed polishers. Use with 3M™ Superbuff™ Adapter (PN05710).



Part Number	Pads/Case
051131-05704	6

* Always refer to paint manufacturer's instructions.

3M™ Perfect-It™ III Compound Pad

3M's "Preferred" 100% wool compounding pad. Single-sided featuring the hook-and-look attachment system for quick changing. 100% untwisted wool construction offers a fast and more aggressive cut. Use with 3M™ Hookit™ SBS™ Back-Up Pad (PN05717).



Part Number	Pads/Case
051131-05719	24

3M™ Superbuff™ Buffing Pad

3M's "Better" 100% wool compounding pad. Double-sided construction allows both sides of this pad to be used. Has its own built-in, lightweight support pad that eliminates the need for heavy back-up pads. Soft, usable edge allows access to hard-to-reach areas, and edge burn is virtually eliminated. Fits all standard (5/8" shaft) slow-speed polishers. Use with 3M™ Superbuff™ Adapter (PN05710).



Part Number	Pads/Case
051131-05700	24

3M Compounding Pads

3M™ Superbuff™ 2 Plus 2 Buffing Pad

3M's "Better" 100% blended wool compounding pad. Double-sided, this pad features more flexibility to get into tighter areas and longer life for greater cost savings. Less aggressive than a 100% wool pad, this pad has its own built-in support system that eliminates the need for heavy back-up pads. Fits all standard (5/8" shaft) slow-speed polishers. Use with 3M™ Superbuff™ Adapter (PN05710).



Part Number	Pads/Case
051131-05701	24

3M™ Perfect-It™ III Rounded Edge Foam Compounding Pad

This pad utilizes 3M's patented convoluted foam face, which results in an aggressive, fast-cutting compounding pad. This is a very user-friendly, lint free system.



Part Number	Pads/Case
051131-05734	6

3M Polishing Pads

3M™ Superbuff™ Polishing Pad

3M's "Preferred" 100% blended wool compounding pad. Double-sided and soft-edged, this pad is specially designed for use with a polisher and glaze or wax. Made of extremely fine fibers, this pad produces a high gloss on paint and gelcoat surfaces. It is flexible, light-weight and well-balanced. Fits all standard (5/8" shaft) slow-speed polishers. Use with 3M™ Superbuff™ Adapter (PN05717).



Part Number	Pads/Case
051144-05705	24

3M™ Perfect-It™ Foam Polishing Pad

3M's "Preferred" foam polishing pad. Utilizes a 3M patented convoluted foam face to produce a wheel-mark free finish on various marine substrates when used with glazes. Use with 3M™ Perfect-It™ Back-Up Pad (PN05718).



Part Number	Size	Pads/Bag	Bags/Case
051131-05725	8"	2	12
051131-05726	3"	4	10

3M™ Hookit™ SBS™ Polishing Pad

3M's "Preferred" 100% blended wool polishing pad. Single-sided, this pad utilizes the hook-and-loop attachment system for quick changing. Made of extremely fine fibers, this pad produces a high gloss on paint and gelcoat surfaces when used with glazes or waxes. Use with 3M™ Hookit™ SBS™ Back-Up Pad (PN05717).



Part Number	Pads/Case
051131-05713	24

3M™ Finesse-It™ Natural Buffing Pad

These buffing pads are designed to get you into tight areas not accessible with a conventional polisher. Pads are hook-and-loop backed. 3" version attaches to the 3" 3M™ Finesse-It™ Roloc™ Finishing Pad (PN14736) which mounts in a 3" 3M™ Roloc™ Disc Pad Assembly (PN05540). 5-1/4" version is used with a dual action sander attached to a 5" 3M™ Hookit™ Backup Pad (PN05775 or 77855).



Part Number	Size	Pads/Bag	Bags/Case
051144-87470	3"	10	50
051144-87471	5-1/4"	10	50

3M Buff Pad Accessories

3M™ Superbuff™ Adapter

Adapter used to secure double-sided 3M buff pads to buffer, as well as with 3M™ Perfect-It™ Backup Pad (PN05718).



Part Number	Pads/Case
051144- 05710	10

3M™ Hookit™ SBS™ Back-Up Pad

Back-up pad used with 3M™ Hookit™ SBS™ single-sided polishing pad (PN05713).



Part Number	Pads/Case
051131- 05717	4

3M™ Perfect-It™ Backup Pad

A specially designed backup pad for use with the 3M™ Superbuff™ Adapter (PN05710). This backup pad enables 3M™ Superbuff™ Pad users to use the 3M™ Perfect-It™ Foam Polishing Pad without having to remove the 3M Superbuff adapter from the shaft of the polisher. Fits all standard (5/8" shaft) slow-speed polishers.



Part Number	Pads/Case
051131- 05718	1

3M™ Finesse-It™ Roloc™ Finishing Pad

Holds the 3" 3M™ Finesse-It™ Natural Buffing Pad in place. Provides a soft surface for excellent results. Finishing pad mounts in a 3" 3M™ Roloc™ Disc Pad Assembly (PN05540).



Part Number	Size	Pads/Bag	Bags/Case
051144- 14736	3"	12	12

Scotch-Brite™ High Performance Cloth

The Scotch-Brite™ High Performance Cloth provides ultra cleaning power because of its knitted, interwoven design of water-and oil-absorbing microfibers that lift and trap liquids, grease, dust and dirt particles. Surfaces are left cleaner than with conventional wipes. When used dry or damp, it's excellent for the removal of grease and silicone from injection molded parts, solvents, dust residue, abrasive residue, splatter from welding, compounds, polish residues, waxes and fingerprints.



Part Number	Color	Size	Cloths/Case
048011- 23589	Blue	32cm x 36cm	50
048011- 23649	White	32cm x 36cm	50
048011- 23650	Green	32cm x 36cm	50
048011- 23651	Yellow	32cm x 36cm	50
048011- 23652	Red	32cm x 36cm	50

Part Number	Color	Size	Cloths/Case	Packs/Case
048011- 25972	Blue	32cm x 36cm	3	10
048011- 25942	Blue	32cm x 36cm	5	10

Retail Package

051131- 67408	Blue	32cm x 36cm	1	12
----------------------	------	-------------	---	----

3M™ Perfect-It™ Detailing Cloths

These cloths are safe, chemical-free, streak-free and non-linting. Microfiber design quickly and easily removes oily and filmy residues. They can be used damp or dry on paint, metal, glass and other marine substrates. The cloths are washable, reusable and durable. Available in two sizes.



Part Number	Size	Cloths/Pack	Packs/Case
051131- 06016	12.5" x 14"	6	6
051131- 06017	12.5" x 14"	50	1
051131- 06018	16" x 16"	6	6

Cleaning

3M™ Marine Fiberglass Cleaner and Wax

Designed to remove LIGHT to MEDIUM oxidation, clean, polish and protect fiberglass/gelcoat. Unique liquid formulation combines a compound with a special blend of waxes which restore shine and protect in one application.

One Step Process



Part Number	Container Size	Containers/Case
051131-09009	16 fl. oz. (Liquid)	6
051131-09010	32 fl. oz. (Liquid)	6
051131-09011	1 Gallon (Liquid)	2

3M™ Marine Multi-Purpose Boat Soap

Concentrated formula designed to clean anything from dirty decks to soiled fabrics to degreasing engines. Mix concentrate with water for desired cleaning strength. Cleans grease, oil, grime, algae, fish, blood, dirt, etc. on hulls, decks, upholstery, canvas, carpet and engines. For example: Mix 2 oz. of 3M™ Marine Multi-Purpose Boat Soap with 1 gallon of water for effective hull and deck cleaning.



Part Number	Container Size	Containers/Case
051131-09034	16 oz. (Liquid)	6
051131-09035	32 oz. (Liquid)	6

3M™ Marine Boat Wash

With an easy-to-use attachment system, this formula removes algae, grime, oil, fish blood and dirt from fiberglass/gelcoat, metal and painted surfaces.

Part Number	Container Size	Containers/Case
051131-09060	32 oz. (Liquid)	6

3M™ Marine Non-Skid Deck Cleaner

Designed to clean hard to reach ground-in dirt and stains on non-skid decks. Safe for use on fiberglass, metal and painted surfaces.



Part Number	Container Size	Containers/Case
051131-09063	1 Liter	6

3M™ Marine Vinyl Cleaner and Restorer

Cleans, shines, conditions and protects vinyl, rubber and plastic surfaces. Deep cleans dirt and grime, enhances appearance. Restores natural sheen, protects surfaces. Fresh lemon scent.

One Step Process



Part Number	Container Size	Containers/Case
051131-09029	15 fl. oz.	6

3M™ Marine Black Streak Remover

Designed to remove black streaks. This product is safe for use on fiberglass, metal and painted surfaces.



Part Number	Container Size	Containers/Case
051131-09047	500 ml Spray	6

3M™ Marine Mildew Stain Remover

Unique spray-and-wipe formula quickly removes mildew stains and dirt from vinyl, boat covers, cushions, carpets/fabrics and other marine surfaces. Follow up with 3M™ Marine Mildew Block for lasting protection.

Part Number	Container Size	Containers/Case
051131-09067	16.9 oz. (Liquid)	6

3M™ Marine Superbuff™ Pad

A 6" diameter buffing pad with a 1" wool pile on both sides of the pad. The 3M™ Marine Superbuff™ Pad allows the do-it-yourselfer to recondition and maintain their boat, using their drill to obtain a high-gloss finish like the professional who uses high-speed tools. The unique double face construction allows both sides of the pad to be used. It has a lightweight support pad built into each pad, thus eliminating the need for heavy rubber backup pads. Designed to fit any standard electric drill with its 1/4" arbor and hex-head nut.



Part Number	Pads/Case
051131-09038	12

3M™ Sharpshooter Extra Strength No Rinse Cleaner

This special cleaner is designed to remove such tough stains as grease, lipstick, crayon, black heel marks and smoke film from most washable hard surfaces. Use on walls, floors, partitions, vinyl, chrome, grout, stainless steel, Formica, fiberglass, ceramic or porcelain.



Part Number	Container Size	Containers/Case
048011-13702	5 Gallon Container	1
048011-16861	Quart with 12 Nozzles	12
048011-19344	Quart with 12 Nozzles	12
048011-19349	55 Gallon Container	1

Cleaning

3M™ Detailing Spray Bottle

A 32-oz. fluorinated bottle. Use with 3M™ Detailing General Purpose Spray Trigger Head (PN37717).



Part Number	Description	Containers/Case
051131- 37716	32 oz. Spray Bottle	24

3M™ Detailing General Purpose Spray Trigger Nozzle Head

This long-lasting, adjustable sprayer is red and white in color. The sprayer is for use with water-based 3M™ Detailing Products. For solvent-based 3M products, use 3M™ Solvent Spray Trigger Nozzle Head (PN37718).



Part Number	Description	Each/Case
051131- 37717	Spray Trigger Nozzle Head	24

3M™ Solvent Spray Trigger Nozzle Head

3M™ Solvent Spray Trigger Nozzle Head is a long-lasting, adjustable sprayer that is excellent for 3M solvent-based products. For water-based 3M products, use 3M™ Detailing General Purpose Spray Trigger Nozzle Head (PN37717).



Part Number	Description	Each/Case
051131- 37718	Spray Trigger Nozzle Head	24

3M™ Glass Cleaner

3M™ Glass Cleaner is an easy to use, quick acting, non-streaking aerosol glass cleaner. Excellent for cleaning glass; this product is also effective for use on plastic, chrome or metal.



Part Number	Container Size	Cans/Case
051135- 08888	20 oz. Aerosol	12

Scotchgard™ Cleaner for Rugs and Carpet

A unique carpet cleaner with patented Scotchgard™ protector ingredient so carpets stay cleaner longer. Aerosol will clean 9' x 12' area.



Part Number	Container Size	Cans/Case
021200- 76418	18.5 oz. Aerosol	6

3M™ Carpet Spot Remover and Upholstery Cleaner

A 19 oz. aerosol can designed to clean carpets and upholstery. Releases both oil and water-based soils from carpet and upholstery. Aerosol foam is sprayed directly on spot with minimum of over spray. Requires no rinsing. Wipe or blot area with a clean absorbent cloth.



Part Number	Container Size	Cans/Case
048011- 14003	19 oz. Aerosol	12

Scotchgard™ Upholstery Cleaner and Protector

Designed to clean and protect so spills blot up easily.



Part Number	Container Size	Cans/Case
021200- 01748	14 oz. Aerosol	6

Scotchgard™ Fabric Protector

An effective, safe, easy do-it-yourself-at-home method of treating fabrics. Offers convenient and lasting protection against soil, stains and rain.



Part Number	Container Size	Cans/Case
021200- 00213	14 oz. Aerosol	12

Scotchgard™ Water Repellent for Outdoor Fabrics

Scotchgard™ Water Repellent for Outdoor Fabrics is for heavy-duty repellency. Scotchgard™ Water Repellent for Outdoor Fabrics extra-strength formula gives added protection against rain, salt water, dirt and oily spills. Consumers have indicated a need for heavy-duty water and stain protection for their high-quality outdoor fabrics. Scotchgard™ Water Repellent for Outdoor Fabrics causes no change in look, feel or breathability of fabrics. Great for canvas and outdoor apparel.



Part Number	Container Size	Cans/Case
021200- 59129	14 oz. Aerosol	6

3M™ Tarnishield™ Silver Cleaner

Cleans tarnish away quickly, easily, safely. Polishes as it cleans. Restores natural luster.



Part Number	Container Size	Containers/Case
021200- 76546	10 oz.	6

3M™ Tarnishield™ Copper and Brass Cleaner

Protects as it polishes. Patented ingredient creates an invisible shield that locks tarnish out. Contains no harsh abrasives.



Part Number	Container Size	Containers/Case
021200- 76547	10 oz.	6

Cleaning

3M™ Stainless Steel Cleaner and Polish

This easy-to-apply cleaner and polish is ideally suited for stainless steel, chrome, laminated plastics and aluminum surfaces. With a high-gloss formula, it wipes clean with no streaks or build-up, resists fingerprints and masks surface blemishes. Pleasant lime fragrance. Contains no petroleum distillates.



Part Number	Container Size	Containers/Case
048011-14002	21.5 oz.	12
048011-19927	1 Quart	6

3M™ General Purpose Adhesive Cleaner

A specially blended solvent that provides easy cleanup of most types of adhesives, and quickly removes waxes, greases, oil and tars. When properly used, it will not harm thoroughly dried paint, vinyl or fabrics.



Part Number	Container Size	Containers/Case
051135-08984*	1 Quart Can	6
051135-08986*	5 Gallon Pail	1
051135-08987	20 oz. Aerosol Can	12

* This product cannot be purchased for use in Southern California per the California South Coast Air Quality District Rule 1171.

3M™ Citrus Base Adhesive Remover

A multi-purpose aerosol or bulk cleaner effective in removing many partially dried and some types of fully cured adhesives without leaving a residue.

Part Number	Container Size	Containers/Case
021200-49048	24 oz. Aerosol Can	6
021200-49142	1 Gallon	4
021200-49143	5 Gallon	1
021200-49144	55 Gallon Drum	1
021200-39296	6.25 fl. oz. Can	6

3M™ Citrus Base Cleaner

A multi-purpose cleaner which will dissolve and flush away dirt, grease, tar, most non-curing type adhesive films, and similar substrates. It is a citrus oil based cleaner that emulsifies when flushed with water and contains no petroleum distillates. Use it to clean and degrease metal parts, motors, tools, and concrete. Contains no ozone depleting chemicals.



Part Number	Container Size	Containers/Case
021200-76394	24 fl. oz.	12

3M™ Twist 'n Fill™ Cleaning Chemical Management System

System features a single, compact dispenser that is designed to accurately mix and dispense a wide range of cleaning chemicals. The system dispenses chemicals with one compact dispenser. Unique bottle and cap design lets you interchange chemicals in seconds. Very compact; fits in any closet. Easy to use – just insert bottle, twist and fill! Integral air gap prevents chemical backflow. Flexible – mounts on wall or, for portability, on cart or cleaning equipment. Accurate dispensing technology ensures consistent, effective chemical performance. Automatic 3 gallon per minute dispense rate for bucket applications; 1 gallon per minute for trigger spray bottle applications. Automatic shut-off attachment also available. Tamper-resistant packaging helps control chemical mixing away from the dispenser.



Part Number	Description	Dispensers/Case
048011-23592	Cleaning Chemical Dispenser	1
048011-23593	Cleaning Chemical Dispenser	1

3M™ Heavy Duty Multi-Surface Cleaner

Versatile cleaner removes most spots, stains and grease from washable surfaces. Use to clean carpets, marble, aluminum, stainless steel, chrome, plastics, windows and mirrors.



Part Number	Description	Each/Case
048011-19202	Heavy Duty Multi-Surface Cleaner Concentrate	6

3M™ General Purpose Cleaner

High-performance, all-purpose cleaner. First choice for your everyday cleaning needs. Use to clean non-porous surfaces.



Part Number	Description	Each/Case
048011-19211	General Purpose Cleaner Concentrate	6

3M™ Detailing Squeeze Bottle

A 12-oz. ketchup-style bottle; includes spout top. Use for dispensing compounds, glazes, polishes and liquid wax.



Part Number	Description	Each/Case
051131-37720	1 Bottle and Top	24

Cleaning

3M™ Glass Cleaner

Non-streaking cleaner for windows, glass and mirrors as well as stainless steel, chrome, aluminum, ceramic and plastic.



Part Number	Description	Each/Case
048011-23357	Glass Cleaner Concentrate	6

3M™ 3-in-1 Cleaner

Versatile, low-foaming cleaner used for cleaning non-porous surfaces.



Part Number	Description	Each/Case
048011-23553	3-in-1 Cleaner Concentrate	6

3M™ Heavy Duty Glass Cleaner

Non-streaking, heavy-duty cleaner for windows, glass, mirrors as well as stainless steel, chrome, aluminum, ceramic and plastic.



Part Number	Description	Each/Case
048011-23360	Heavy Duty Glass Cleaner Concentrate	6

Sponges, Scrubs and Cloths

3M™ Doodlebug™ Cleaning System

3M™ Doodlebug™ Products offer a versatile cleaning system that can make your cleaning job easier, more effective and less costly. Choose from two styles of holders, four cleaning pads and a brush. They're designed for most cleaning tasks, from light-duty cleaning of delicate surfaces to heavy-duty cleaning of dirt and finishing buildup.

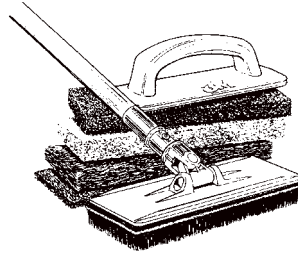

The pads and brush all easily attach to the holders, which feature special hook-and-loop grippers that hold them firmly in place. The Doodlebug cleaning system is especially effective when used with cleaning chemicals such as 3M™ TroubleShooter™ Cleaners, and 3M™ Sharpshooter™ Extra-Strength, No-Rinse Cleaner.

3M™ Doodlebug™ Holders

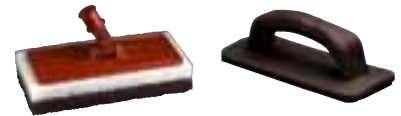

Part Number	Description	Application	Holders/Case
6472	Pad Holder	Attaches to brush/broom handle	4
6473	Hand Block	Convenient built-in handle designed to be gripped by hand for hand	4

3M™ Doodlebug™ Pads

Part Number	Description	Application	Pads/Box	Pads/Case
4-1/2" x 10"				
8440	White Cleansing Pad	Delicate surfaces and light cleaning jobs	5	4
8242	Blue Cleaning Pad	Medium duty cleaning jobs	5	4
8541	Brown Scrub 'N Strip Pad	Heavy-duty pad for tough cleaning and stripping jobs	5	4
4-5/8" x 10"				
8550	High Productivity Stripping Pad	Most aggressive pad. Heavy-duty maintenance and stripping jobs	10	4

Sponges, Scrubs and Cloths

Scotch-Brite™ Scrubs

Three grades of Scotch-Brite™ material permanently bonded to a handle to provide ease and quickness for a variety of cleaning tasks.



Part Number	Product Type	Each/ Pack	Packs/ Case
021200-01008	Grill-Black (7721)	4	12
021200-01009	Floor-Blue (7722)	4	12
021200-01010	Bath-White (7723)	4	12

Scotch-Brite™ Tub and Sink Scrub Sponge — No. 445

Durable nonwoven nylon laminated to a pure cellulose sponge.



Part Number	Sponges/Case
021200-00002	12

O-Cel-O™ Stay Fresh Home, Car and Boat Sponge

An excellent choice for big cleaning jobs on your boat. Excellent boat bailer.



Part Number	UPC Number	Size	Sponges/ Case
7220T	053200-07220	9" x 4-1/2" x 1-3/4"	12

3M™ C-31 Large Commercial Sponge

An excellent quality sponge for multiple boat cleanup duties.



Part Number	UPC Number	Size	Sponges/ Case
7449T	053200-07449	6" x 4-1/4" x 1-5/8"	24

Scotch-Brite™ Lens Cleaning Cloth

Ribbon-shaped fibers lift dirt and grease instead of rolling over it. Dirt and particles are trapped within knitted tufts of the fibers. Rows and rows of tufts and valleys trap large and small particles.



Part Number	UPC Number	Description	Each/ Case
9021	051111-11169	Lens Cloth with Countertop Merchandiser	20
9021CS	051111-11239	Clip Strip	2 Clips of 6

3M™ Synthetic Steel Wool Pads

A combination of synthetic fibers and abrasive particles that work like steel wool. Yet these durable pads are easier on hands, resist clogging, and can be rinsed and reused. 3M™ Synthetic Steel Wool Pads won't rust, splinter or shred. They outlast steel wool. 3M synthetic steel wool pads are compatible with both solvent-based and water-based stains and finishes.



Part Number	Grade	Pads/ Pack	Packs/ Case
051111-10115	#3 Coarse	6	18
051111-10116	#2 Medium	6	18
051111-10118	#2 Medium	6	18
051111-10120	"000" Extra Fine	6	18

Scotch-Brite™ High Performance Cloth

Provides ultra cleaning power because of its knitted, interwoven design of water- and oil-absorbing microfibers that lift and trap liquids, grease, dust and dirt particles. Surfaces are left cleaner than with conventional wipes. When used dry or damp, it's excellent for the removal of grease and silicone from injection molded parts, solvents, dust residue, abrasive residue, splatter from welding, compounds, polish residues, waxes and fingerprints.











Part Number	Color	Size	Cloths/Case
048011-23589	Blue	32cm x 36cm	50
048011-23649	White	32cm x 36cm	50
048011-23650	Green	32cm x 36cm	50
048011-23651	Yellow	32cm x 36cm	50
048011-23652	Red	32cm x 36cm	50

Part Number	Color	Size	Cloths/ Case	Packs/ Case
048011-25972	Blue	32cm x 36cm	3	10
048011-25942	Blue	32cm x 36cm	5	10

Retail Package

051131-67408	Blue	32cm x 36cm	1	12
--------------	------	-------------	---	----

3M Masking Tapes

	Scotch® Masking Tapes		Scotch® Paint Striping Tapes			Scotch® Weather-Resistant Tapes		
	233+	2040	218	256	471	2090	225	4811
								
Application Guide								
Critical Masking	■		■	■	■	■	■	
Utility/General Purpose		■						
Paint Striping/Color Separation			■	■	■			
Holding/Building		■						
Conformability	■				■	■		
Indoors or less than 24 Hours Outdoors	■	■	■	■	■	■	■	■
Outdoors more than 24 Hours but less than 5 Days				■	■	■	■	■
Outdoors more than 24 Hours but less than 14 Days					■	■	■	■
Outdoors 14 to 30 Days					■		■	■
Tape on 30 Days to 1 Year								■

Metric Width	Standard Width
3mm	1/8"
6mm	1/4"
12mm	1/2"
18mm	3/4"
21mm	7/8"
24mm	1"
36mm	1-1/2"
48mm	2"
72mm	3"
96mm	4"

3M Masking Tapes

Scotch® Performance Masking Tape 233+

3M's "Preferred" indoor or single-day outdoor critical masking tape. This highly conformable tape provides outstanding paint lines. It consistently performs under a variety of climactic conditions.



Part Number	Size	Rolls/Case
051131- 26330	6mm x 55m (1/4" applications)	96
051131- 26332	12mm x 55m (1/2" applications)	48
051131- 26334	18mm x 55m (3/4" applications)	48
051131- 26336	24mm x 55m (1" applications)	24
051131- 26338	36mm x 55m (1-1/2" applications)	16
051131- 26340	48mm x 55m (1" applications)	12
051131- 26341	72mm x 55m (3" applications)	8
051131- 26343	3mm x 55m (1/8" applications)	12
051131- 26344	6mm x 55m (1/4" applications)	12

Scotch® Paint Masking Tape — No. 233

3M's "Better" indoor or single-day outdoor critical masking tape. Designed specifically for the professional painter, this tape is conformable, hugs curves and contours, goes on quick and easy, sticks at a touch and stays put. Well suited for boats, trucks and aircraft. Not for extended outdoor use.

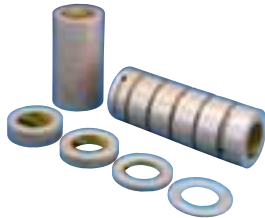

Part Number	Size	Rolls/Case
021200- 06330	1/4" x 60 yds.	144
021200- 06332	1/2" x 60 yds.	72
021200- 06334	3/4" x 60 yds.	48
021200- 06336	1" x 60 yds.	36
021200- 06338	1-1/2" x 60 yds.	24
021200- 06340	2" x 60 yds.	24
021200- 06341	3" x 60 yds.	12
021200- 06343	1/8" x 60 yds.	12
021200- 06344	1/4" x 60 yds.	12

Scotch® Solvent Resistant Masking Tape — No. 2040

This tape is ideal for solvent-based and lacquer coatings. Ideal for use in cool temperatures. High adhesion to most surfaces and high holding power.

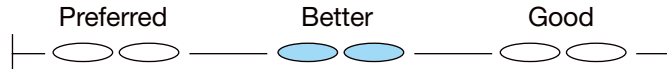

Part Number	Size	Rolls/Case
021200- 02991	18mm x 55m	48
021200- 02992	24mm x 55m	36
021200- 02993	36mm x 55m	24
021200- 04365	48mm x 55m	24
021200- 02994	72mm x 55m	12

Scotch® Masking Tape for General Painting — No. 2050

This tape can be removed cleanly for up to 3 days. It features medium adhesion and is ideal for window, door and wall trim and for masking cabinets, carpet, and vinyl flooring. Good for interior and exterior use.



Part Number	Size	Rolls/Case
021200- 05617	.70" x 2160"	48
021200- 05618	.94" x 2160"	36
021200- 05619	1.41 x 2160"	24
021200- 05620	1.88 x 2160"	24
021200- 05621	2.83" x 2160"	12

3M Paint Striping Tapes

Scotch® Fine Line Tape – No. 218

3M's "Preferred" indoor or single-day outdoor paint striping tape. This specially extruded matte finish green polypropylene tape provides the finest color line separation available because of its thinness. Stretches easily for smooth curves, yet tears easily by hand. Excellent solvent and moisture resistance. Allows taping over freshly cured lacquer, enamel and urethane paint systems sooner with less chance of imprint damage. Not for extended outdoor use.

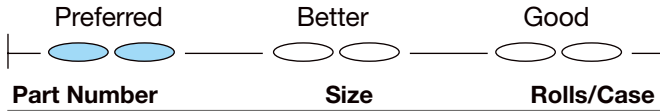

Part Number	Size	Rolls/Case
Boxed		
021200- 06300	1/8" x 60 yds.	12
021200- 06301	1/4" x 60 yds.	12
021200- 06302	3/8" x 60 yds.	12
021200- 06303	1/2" x 60 yds.	12
021200- 06305	3/4" x 60 yds.	12
021200- 06306	1/16" x 60 yds.	12
021200- 06307	3/16" x 60 yds.	12
021200- 06308	3/32" x 60 yds.	12
Bulk		
021200- 16028	1/4" x 60 yds.	144
021200- 04698	1/2" x 60 yds.	71
021200- 04699	3/4" x 60 yds.	48
021200- 04700	1" x 60 yds.	36
021200- 04701	2" x 60 yds.	24

3M Scotchmark Green Masking Tape – No. 256

3M's "Preferred" outdoor paint striping tape. A treated, flatback tape with good adhesive characteristics and a surface color-coating of light green. Has a smooth, sharp edge and doesn't lose its shape when applied over a long, continuous horizontal surface such as masking for painting of a boats boot stripe. Provides ultraviolet (UV) stability and adhesive transfer resistance up to five days from application.



Part Number	Color	Size	Rolls/Case
021200- 05423	Green	3/4" x 60 yds.	48
021200- 04968	Green	1" x 60 yds.	36
051115- 17688	Green	2" x 60 yds.	24

Scotch® Plastic Tape – No. 471, Blue

3M's "Preferred" paint striping tape for extended outdoor use. A blue vinyl plastic tape that is highly conformable and is excellent for masking off areas for detailed boat and boot stripe painting. Also excellent for masking over rivets or aluminum boats. Provides ultraviolet (UV) stability and adhesive transfer resistance up to 30 days from application.



Part Number	Color	Size	Rolls/Case
Boxed			
051131- 06404	Blue	1/8" x 36 yds.	12
021200- 06405	Blue	1/4" x 36 yds.	12
051131- 06408	Blue	1/2" x 36 yds.	12
051131- 06409	Blue	3/4" x 36 yds.	12
Bulk			
021200- 61192	Blue	1/4" x 36 yds.	144
021200- 03119	Blue	1/2" x 36 yds.	72
021200- 03120	Blue	3/4" x 36 yds.	48
021200- 03121	Blue	1" x 36 yds.	36

3M Weather Resistant Tapes

Scotch® Blue Painters Tape for Multi-Surfaces — No. 2090



This medium adhesion conformable crepe-backed tape removes cleanly from the surface for up to 14 days. The painter's tape is sunlight resistant and is recommended for interior and exterior use. 2090 is ideal for most painted surfaces such as: painted walls, trim and woodwork; glass and metal. Water-based and solvent based coatings can be applied. Not compatible with lacquer coatings or surfaces.



Part Number	Color	Size	Rolls/Case
051115- 06817	Blue	3/4" x 60 yds.	48
051115- 06818	Blue	1" x 60 yds.	36
051115- 06819	Blue	1-1/2" x 60 yds.	24
051115- 06820	Blue	2" x 60 yds.	24

Scotch® Silver Weather Resistant Masking Tape — No. 225

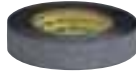

3M's "Preferred" critical masking tape for extended outdoor use. The silver colored coating on the backing of this crepe paper tape reflects ultraviolet (U.V.) light to provide weather resistance for up to a month's time. Prevents slivering and adhesive transfer during unmasking.



Part Number	Color	Size	Rolls/Case
021200- 02828	Silver	3/4" x 60 yds.	48
021200- 02829	Silver	1" x 60 yds.	36
021200- 02830	Silver	1-1/2" x 60 yds.	24
021200- 04597	Silver	2" x 60 yds.	24

Scotch® White Preservation Tape — No. 4811



A white, pressure-sensitive tape designed for use in sealing of plastic sheeting, tarps, and shrinkwrap for boat storage and over-the-road transportation. Applies well in cold weather and is resistant to hot and cold temperatures. Is also resistant to common lubricants and strippable coatings. Removes cleanly and easily up to two years after application when properly applied.

Part Number	Color	Size	Rolls/Case
021200- 42425	White	1" x 36 yds.	36
021200- 62334	White	2" x 36 yds.	24
021200- 62335	White	3" x 36 yds.	12
021200- 42426	White	4" x 36 yds.	12

Scotch® Black Preservation Tape — No. 481



A pigmented black plastic film tape that conforms readily to irregular surfaces and has excellent stain resistance. Resists hot and cold weathering over two years. Removes cleanly and quickly. Uses include holding and sealing poly and other covering material to sides of boats during storage and shipment.

Part Number	Color	Size	Rolls/Case
021200- 03174	Black	1" x 36 yds.	36
021200- 04319	Black	2" x 36 yds.	24
021200- 03175	Black	3" x 36 yds.	12

Safe Release Tapes

Scotch® Safe-Release™ Masking Tape – No. 2070

A white-colored, flat-back paper masking tape utilizing a low-tack adhesive system that provides safe removal without damage to delicate surfaces. This tape should be used in place of higher tack masking tapes if the risk of “lifting” or pulling up of an existing finish (paint or varnish) is possible. Can also be used as a paint striping masking tape, providing sharp paint lines.



Part Number	Color	Size	Rolls/Case
051115- 02501	White	3/4" x 60 yds.	24
051115- 00445	White	1" x 60 yds.	24
051115- 02502	White	1-1/2" x 60 yds.	12
051115- 00444	White	2" x 60 yds.	12

Scotch® Scotch-Blue™ Painters Tape for Delicate Surfaces – No. 2080

This low to medium adhesion flat-back tape removes cleanly from the surface for up to 60 days. The painter's tape is sunlight resistant and is recommended of interior and exterior use. 2080 is ideal for most smooth or delicate surfaces such as: most fresh paints (24-hours old), vinyl-coated wallpaper, primed wallboard, wood floors and faux painting. Water-based, solvent based and stain coatings can be applied. Not compatible with lacquer coatings or surfaces.



Part Number	Size	Rolls/Case
051131- 80988	3/4" x 60 yds.	48
051131- 79748	1" x 60 yds.	36
051131- 79749	1-1/2" x 60 yds.	24
051131- 79750	2" x 60 yds.	24

General Purpose Tapes

Tartan™ Paper Tape – No. 200

A utility purpose paper tape used for holding, bundling and sealing. Ideal for paint suit sleeve and shoe wrapping. Not to be used for paint masking.

Part Number	Size	Rolls/Case
048100- 53469	12mm X 55m	72
048100- 53464	18mm X 55m	72
048100- 53465	24mm X 55m	48
048100- 53470	36mm X 55m	36
048100- 53466	48mm X 55m	24
048100- 53467	72mm X 55m	12
048100- 53468	96mm X 55m	8

3M™ Masking Tape 2308

Natural colored crepe paper. A general purpose masking tape for holding, bundling, sealing, general paint masking and a vast number of other jobs where a pressure-sensitive tape is needed.



Part Number	Size	Rolls/Case
051131- 06545	18mm X 55m	48
051131- 06547	36mm X 55m	24
051131- 06548	48mm X 55m	24

3M™ Paper Masking Tape – No. 2214

This is a general purpose tape for holding, bundling, sealing, non-critical masking and a vast number of other jobs where a pressure-sensitive tape is needed.

Part Number	Size	Rolls/Case
021200- 45587	12mm x 55m	64
021200- 26074	18mm x 55m	64
021200- 26075	24mm x 55m	64
021200- 26076	36mm x 55m	64
021200- 26077	48mm x 55m	48
021200- 26078	72mm x 55m	64
021200- 48119	96mm x 55m	64

3M Duct Tapes

3M™ Performance Plus Duct Tape 8979

A unique construction of high tensile cloth and aggressive adhesive. Designed for permanent and temporary applications both indoors and outdoors. Sunlight/UV Resistance allows for clean removal with little or no adhesive residue for up to 6 months.

	Part Number	Size	Rolls/Case
NEW	048011- 53299	24mm X 55m	48
NEW	048011- 56468	48mm X 55m	24
NEW	048011- 56469	72mm X 55m	12
NEW	048011- 56470	96mm X 55m	12

3M™ Duct Tape 3939

A heavy duty silver cloth duct tape with strong backing, good adhesion, tears easily without curling, conformability and low tack edges. Ideal for hanging poly, holding, patching, bundling, sealing and temporary repair. Tensile strength 26 lbs./in.

	Part Number	Size	Rolls/Case
	021200- 85561	24mm x 54.8m	36
	051131- 06975	48mm x 54.8m	24
	021200- 85562	72mm x 54.8m	12
	021200- 85563	96mm x 54.8m	12

Scotch® Heavy Duty All Weather Duct Tape

Heavy duty tape is longer lasting outdoors. UV and water resistant backing resists drying, cracking and peeling.

	Part Number	Tape Number	Size	Rolls/Case
	051131- 92040	2245-A	1.88" x 45 yds.	12

Scotch® Transparent Duct Tape

Ideal for use where appearance matters, this tape ends the ugly repairs associated with traditional gray duct tapes.



	Part Number	Tape Number	Size	Rolls/Case
	051131- 83260	2120-A	1.88" x 20 yds.	12

Scotch® Professional HVAC Duct Tape

Ideal for industrial and HVAC applications. Meets UL 723.

	Part Number	Tape Number	Size	Rolls/Case
	051131- 50253	132DC-BA	1.88" x 20 yds.	24
	051131- 50254	132DC-BA	1.88" x 60 yds.	24

Scotch® Colored Cloth Tape – No. 220

Ideal for crafts, color matching and identifying.

	Part Number	Tape Number	Color	Size	Rolls/Case
	051131- 86851	220RED-A	Red	1.88" x 20 yds.	12
	051131- 86862	220BRN-A	Brown	1.88" x 20 yds.	12
	051131- 86849	220BLU-A	Blue	1.88" x 20 yds.	12
	051131- 86848	220BLK-A	Black	1.88" x 20 yds.	12
	051131- 86850	220GRN-A	Green	1.88" x 20 yds.	12
	051131- 86852	220WHT-A	White	1.88" x 20 yds.	12
	051131- 86853	220YLW-A	Yellow	1.88" x 20 yds.	12

Tartan™ Utility Duct Tape – No. 955

Utility grade duct tape for bundling, sealing, and holding.

	Part Number	Tape Number	Size	Rolls/Case
	051131- 59094	955-K	1.88" x 55 yds.	240

Protective Tapes Long Term

Scotch® Plastic Chafing Tape – No. 471, White

A white vinyl plastic tape that is highly conformable and withstands heavy abrasion. It is commonly used in marine as a chafing tape to protect dock, mooring and rigging lines, turn buckles, shrouds and spreaders. Not recommended for use on vinyl or other plastics containing migrating-type plasticizers.



Part Number	Color	Size	Rolls/Case
021200-03135	White	3/4" x 36 yds.	48
021200-03136	White	1" x 36 yds.	36

Scotchgard™ Paint Protection Film

A yellowing-resistant, clear protection film for reducing stone chipping and bug damage on painted surfaces. Excellent for hoods, valances, rocker areas, etc. For new cars and for refinished vehicles. **Non-returnable product.**

Part Number	Film Thickness	Roll Size	Rolls/Case
Rolls			
NEW 051141-84701	14 mils*	1" x 12.5 yds.	6
NEW 051141-84706	14 mils*	6" x 20 yds.	4
NEW 051141-84802	8 mils*	2" x 40 yds.	24
NEW 051141-84804	8 mils*	4" x 40 yds.	12
NEW 051141-84806	8 mils*	6" x 40 yds.	8
Strips			
NEW 051141-84904	8 mils*	4" x 84"	20
NEW 051141-84906	8 mils*	6" x 84"	15
NEW 051141-84911	8 mils*	12" x 84"	18

* Total thickness including 2-mil adhesive.

Scotchgard™ Paint Protection Film Door Edge Guard

6-mil, clear coated urethane film with PSA. Used to protect door edges from potential nicks and abrasion. Use on new or recently refinished vehicles.



Part Number	Thickness	Roll Size	Rolls/Case
051141-84901	6mm base (9mm with adhesive)	.4" x 10 yds.	12
051141-84905	6mm base (9mm with adhesive)	.4" x 40 yds.	12

Scotchgard™ Paint Protection Film Door Edge Guard

3M Marine Rigging Tape helps prevent turnbuckles, cotter pins, rigging wire, stanchions, spreaders and chainplates from chafing sales, lines and sheets. The self-bonding tape is water and UV resistant.

Part Number	Size	Rolls/Case
054007-55512	1" x 10 ft.	32

Protective Tapes Short Term

3M™ Marine Heavy Duty Protection Tape – No. 346

Abrasion resistant. Its 17 mils thickness gives outstanding protection against scuffing and tearing. It offers protection to topside surfaces and cabin soles of boats under construction or repair/restoration. Its adhesive transfer resistance makes it ideal for use wherever protection from wear or damage is needed; as a temporary carpet for new boat display, to protect plastic portlites and windshields from scratches during installation, prevents damage to painted, varnished, gelcoated surfaces, wooden decks or fiberglass decks.

Part Number	Thickness	Roll Size	Rolls/Case
021200-05418	17 mils	12" x 60 yds.	4
021200-05419	17 mils	18" x 60 yds.	1
021200-05420	17 mils	24" x 60 yds.	1
021200-05421	17 mils	36" x 60 yds.	1

3M™ Protective Tape SCPM 44X

A 6-mil, medium-high tack protective tape with anti-slip properties. Applications include protecting aggregate and diamond patterned non-skid, gelcoat, paint, wood and counter top surfaces during boat or RV assembly and repair processes. For indoor use only.

Part Number	Roll Size	Rolls/Case
NEW 051128-74779	12" x 100 yds.	1
NEW 051128-74780	18" x 100 yds.	1
NEW 051128-30379	24" x 100 yds.	1
NEW 051128-30378	36" x 100 yds.	1
NEW 051128-30377	48" x 100 yds.	1

Thinsulate™ Sound and Thermal Insulation

Thinsulate™ Marine Insulation

Thinsulate™ Marine Insulation is a non-woven mat that has excellent sound-absorbing properties useful in many marine interior applications. It is compressible, non-linting, lightweight, hydrophobic (does not absorb moisture) and it can be easily die-cut.

	Product	Covering	Roll Width	Roll Length	Roll Area	Part Number
MA4700 Series Thickness: 3/4" – 1" (19 – 26mm) Weight: 1.4 oz/ft ² (417g/m ²) For filling gaps: 1/2" – 1" (13 – 26mm) R value 4 at 26mm thickness	MA4700	None	30" (76cm)	270' (82m)	675 ft ² (63m ²)	Discontinued
			60" (1.52cm)	90' (27m)	450 ft ² (42m ²)	Discontinued
			60" (1.52cm)	270' (82m)	1350 ft ² (125m ²)	Discontinued
	MA4710	Black	30" (76cm)	375' (114m)	937 ft ² (87m ²)	76768
			60" (1.52cm)	90' (27m)	450 ft ² (42m ²)	76769
			60" (1.52cm)	375' (114m)	1875 ft ² (174m ²)	76631
	MA4720	White	30" (76cm)	375' (114m)	937 ft ² (87m ²)	Discontinued
			60" (1.52cm)	90' (27m)	450 ft ² (42m ²)	Discontinued
			60" (1.52cm)	375' (114m)	1875 ft ² (174m ²)	Discontinued
	MA4720M	Metal Film	25" (63cm)	225' (69m)	469 ft ² (44m ²)	Discontinued
			50" (1.27cm)	90' (27m)	375 ft ² (35m ²)	Discontinued
			60" (1.52cm)	90' (27m)	450 ft ² (42m ²)	91972
50" (1.27cm)			225' (69m)	937 ft ² (87m ²)	Discontinued	
MA4700 Series Thickness: 1-1/2" – 2" (38 – 51mm) Weight: 2.0 oz/ft ² (617g/m ²) For filling gaps: 1" – 2" (25 – 51mm) R value 6 at 44mm thickness	MA6710	Black	30" (76cm)	225' (69m)	562 ft ² (52m ²)	76774
			60" (1.52cm)	90' (27m)	450 ft ² (42m ²)	76775
			60" (1.52cm)	225' (69m)	1125 ft ² (104m ²)	76633
	MA6720	White	30" (76cm)	225' (69m)	562 ft ² (52m ²)	Discontinued
			60" (1.52cm)	90' (27m)	450 ft ² (42m ²)	Discontinued
			60" (1.52cm)	225' (69m)	1125 ft ² (104m ²)	76634
	MA6720M	Metal Film	25" (63cm)	150' (46m)	312 ft ² (29m ²)	Discontinued
			50" (1.27cm)	90' (27m)	375 ft ² (35m ²)	Discontinued
60" (1.52cm)			90' (27m)	450 ft ² (42m ²)	91971	
50" (1.27cm)			150' (46m)	625 ft ² (58m ²)	Discontinued	

Marking Tapes

3M™ Hazard Marking Vinyl Tape 766

A general purpose hazard marking vinyl tape for use in non-critical applications. Can be used to mark equipment pinch points, and temporary floor marking around equipment or spills.

Part Number	Color	Size	Rolls/Case
021200- 43181	Black/Yellow	2" x 36 yds.	24

3M™ Hazard Marking Vinyl Tape 767

Red and white stripe, 5-mil (0.125-mil) vinyl backing with rubber adhesive. Stripes promote employee safety by marking pinch points or gears on equipment. Provides temporary floor marking around equipment or spills. Mark risers on stairways or low-clearance areas.

Part Number	Color	Size	Rolls/Case
021200- 43186	Red/White	2" x 36 yds.	24

Scotch® 300 Series Barricade Tapes

Effective and economical with 300 and 1000 feet of tape per roll. One roll has sufficient length to designate a large area. It is constructed of durable polyethylene plastic and measures 3- or 4-mil thick, which prevents accidental tearing. Bold, two-inch, black characters on a bright yellow or red background are sure to attract attention and ensure that a warning message is clearly visible. The Scotch® 300 Series Barricade Tapes are non-adhesive, non-lead, polyethylene tapes. The tapes are a fast, effective way to restrict entry into hazardous areas. "Caution" is printed repeatedly in bold, black characters on a bright yellow or red background. The roll dimensions are 3" x 1000' or 3" x 300' with a nominal 3- or 4-mil thickness. Each roll is individually shrink-wrapped.



Part Number	Size	Rolls/Case
055128- 53042	3" x 1000'	8
055128- 53460	3" x 300'	16

Tartan™ Color Cloth Tape

An economical 9-mil thick tape constructed of polyethylene film bonded to a strong polycotton blend cloth. This tape is conformable and also provides good weather and moisture resistance. Available in assorted colors for mending vinyl seat cushions, canvas boat covers, plastic tarps, etc.



Part Number	Size	Color	Rolls/Case
051131- 58709	48mm x 45.8m	Black	12
051131- 58727	48mm x 45.8m	Brown	12
051131- 58728	48mm x 45.8m	Red	12
051131- 58729	48mm x 45.8m	White	12

Scotch® Colored Plastic Tape

Super thin, stretchy, waterproof vinyl plastic tape in two sizes. Each roll is cellophane wrapped. Mends, decorates, identifies. Great for color-coding and identifying rigging lines on sailboats. Available in red, green, brown, white, yellow, blue, black and clear.



Part Number	Color	Rolls/Pack	Packs/Case
Catalog No. 190-3/4" x 125"			
021200- 00006	Clear	6	72
021200- 00007	Red	6	72
021200- 00008	Blue	6	72
021200- 00009	White	6	72
021200- 00010	Brown	6	72
021200- 00011	Yellow	6	72
021200- 00012	Green	6	72
021200- 00013	Black	6	72
Catalog No. 191 – 1-1/2" x 125"			
021200- 00014	Clear	6	72
021200- 00015	Red	6	72
021200- 00016	Blue	6	72
021200- 00017	White	6	72
021200- 00018	Brown	6	72
021200- 00019	Yellow	6	72
021200- 00020	Green	6	72
021200- 00021	Black	6	72

Filament Strapping Tape and Dispensers

Scotch® Filament Tape — No. 898

Excellent for bundling elongated metal and wood parts and for sealing and reinforcing cartons containing heavy items for shipment. This strong, high performance tape adheres instantly. Tensile strength is 380 lbs./inch.



Part Number	Size	Rolls/Case
Boxed		
051131- 06893	12mm x 55m	12
051131- 06894	18mm x 55m	12
051131- 06895	24mm x 55m	12
Bulk		
051131- 06896	12mm x 55m	72
051131- 06897	18mm x 55m	48
051131- 06898	24mm x 55m	36

Scotch® Filament Tape — No. 893

An economical transparent filament tape for general and miscellaneous packaging. Tensile strength is 300 lbs./inch.



Part Number	Size	Rolls/Case
Bulk		
051131- 06937	12mm x 55m	72
051131- 06938	18mm x 55m	48
051131- 06939	24mm x 55m	36

Scotch® Filament Tape — No. 897

A commercial grade filament tape for use when a medium-duty reinforced tape is required.



Part Number	Size	Rolls/Case
021200- 86523	12mm x 55m	72
021200- 86524	18mm x 55m	48
021200- 86525	24mm x 55m	36

Tartan™ Filament Tape — No. 8934

General purpose strapping tape designed for light-duty strapping applications such as reinforcing boxes and bundling light items.



Part Number	Size	Rolls/Case
021200- 86518	12mm x 55m	72
021200- 86519	18mm x 55m	48
021200- 86520	24mm x 55m	36

Scotch® H-10 Filament Tape Hand Dispenser

Accommodates all listed widths of filament tapes shown. **NOTE: PRODUCT IS NOT INCLUDED WITH THE DISPENSER.**



Part Number	Dispensers/Case
021200- 06910	6

Scotch® H-12 Filament Tape Hand Dispenser

Features a hand brake in the core that allows operator to adjust tension for tighter box reinforcement and bundling applications. Made from high-impact, durable plastic. Handles filament tapes up to 1" wide. **NOTE: PRODUCT IS NOT INCLUDED WITH THE DISPENSER.**



Part Number	For Use With	Dispensers/Case
021200- 06953	Up to 1" Width Roll	6

Box Sealing Tapes and Dispensers

3M™ Scotchpro™ Box Sealing Tape — No. 3750

A strong film tape that is excellent for box sealing, recouperage, fiber drum sealing and other heavy duty packaging applications. Available in transparent and tan colors.



Part Number	Color	Size	Rolls/Case
051131- 06639	Transparent	36mm x 50m	36
051131- 06640	Transparent	48mm x 50m	36
051131- 06642	Tan	48mm x 50m	36

Highland™ Commercial Grade Box Sealing Tape — No. 3710

A strong film tape that conforms to box surfaces for a consistent uniform seal with no water or sticky cleanup. Resists center seam splitting and seals out moisture, dust and dirt. Ideal for most packaging needs.



Part Number	Color	Size	Rolls/Case
021200- 14765	Tan	48mm x 50m	36
021200- 14766	Clear	48mm x 50m	36
021200- 18813	Clear	48mm x 100m	36

Scotch® Labelgard™ Tape — No. 8210

Designed for the attachment and protection of address labels on a wide variety of shipping and mailing containers.



Part Number	Size	Rolls/Case
021200- 06888	4" x 72 yds.	8

Scotch® Packing List Tape — No. 8240

A unique tape which is used to attach and protect packing lists, shipping papers and other documents to a wide range of shipping containers. Quick, inexpensive, easy! Use with 3M™ M-727 Labelgard™ Tape Dispenser (PN06944).



Part Number	Pouches/Roll	Size	Rolls/Case
021200- 06947	500	5" x 6"	8

3M™ ScotchPad™ 8240-P Packing List Tape

A unique tape which is available in convenient pad form. It offers a convenient system for attaching packing lists, shipping papers and other documents to a wide array of shipping containers. There is no dispenser necessary.



Part Number	Sheets/Pad	Pads/Carton	Cartons/Case
051131- 06954	25	40	5

Scotch® Packing List Tape — No. 825

This tape has a tough, scuff-resistant backing and aggressive packaging adhesive to securely attach packing lists and other mailing documents to most shipping container surfaces. It has a bright orange "Document Enclosed" border that makes packing lists easy to locate and remove without tearing documents.



Part Number	Pouches/Roll	Size	Rolls/Case
021200- 17063	250	5" x 6"	16

Scotch® 3750-RD Box Sealing Tape with Reusable Dispenser

The same 3M™ Scotchpro™ High Performance Box Sealing Tape but mounted in its own red reusable dispenser. This reusable dispenser makes it extremely convenient to use in a variety of locations without making an investment in extra dispensers.



Part Number	Color	Size	Rolls/Case
021200- 39523	Clear	48mm x 50m	24
021200- 39524	Tan	48mm x 50m	24

3M™ H-122 Box Sealing Dispenser

A lightweight and durable hand dispenser for box sealing tapes. **NOTE: PRODUCT IS NOT INCLUDED WITH THE DISPENSER.**



Part Number	For Use With	Dispensers/Case
021200- 06925	Up to 2" Width Roll	6

Box Sealing Tapes and Dispensers

Tartan™ HB-903 Pistol Grip Sealing Tape Dispenser

Easy-to-use, one-handed box sealing tape dispenser has an adjustable braking mechanism which applies tension to the tape. Refillable. **NOTE: PRODUCT IS NOT INCLUDED WITH THE DISPENSER.**



Part Number	For Use With	Dispensers/Case
051131-06997	Up to 2" Width Roll	24

3M™ M-727 Labelgard™ Tape Dispenser

Unique streamline construction allows for wall or bench mounting. **NOTE: PRODUCT IS NOT INCLUDED WITH THE DISPENSER.**

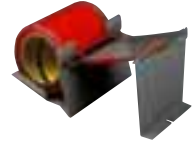

Part Number	For Use With	Dispensers/Case
021200-06944	Up to 4" Width Roll	6

3M™ M-707 Labelgard™ Dispenser

For address label applications. Applies and protects labels in one operation. **NOTE: PRODUCT IS NOT INCLUDED WITH THE DISPENSER.**



Part Number	For Use With	Dispensers/Case
021200-06923	Up to 4" Width Roll	6

Adhesive Transfer Tapes

Scotch® ATG Adhesive Transfer Tape

Use this tape to hold, attach, bond, laminate, tab, join, fasten, mount, splice or seal nearly any surface – paper, foils, films, fabrics, glass, foams, plastics, metal, painted surfaces and wood. Tape is thin and tacky on both sides; one side adheres to applied surface, the other side is immediately ready to join a second surface. Provides instant tack and strong constant bond.



Part Number	Product		Size	Rolls/Case
	Number	Thickness		
021200-04850	950	5 mils	1" x 60 yds.	50
051131-06491	924	2 mils	1/2" x 36 yds.	50
051131-06492	924	2 mils	3/4" x 36 yds.	50
051131-06493	969	5 mils	1/2" x 18 yds.	50

Scotch® Adhesive Transfer Tape – No. 465

Acrylic adhesive on a silicone-coated paper liner. Adhesive transfers from the liner easily to most smooth surfaces. Initial adhesion is very high. Used for miscellaneous holding, laminating, mounting and bonding applications.



Part Number	Size	Rolls/Case
021200-03337	1" x 60 yds.	36

Scotch® ATG Dispenser

This dispenser is designed for use with our Scotch® ATG Tapes for easy dispensing. **NOTE: PRODUCT IS NOT INCLUDED WITH THE DISPENSER.**



Part Number	Each/Case
021200-06927	6

Pipe Thread Sealant Tape

Scotch® Pipe Thread Sealant Tape – No. 48

This tape rolls on dry and molds into pipe threads to form a leak-proof seal. Unaffected by oils, transmission fluids or freon and never dries out. Permanently lubricated joints never stick.



Part Number	Size	Rolls/Case
054007- 06192	1/4" x 260"	12
054007- 06195	1/2" x 260"	12
054007- 06196	1/2" x 520"	12

Foam and Paper Tapes

3M™ Double-Coated Urethane Foam Tapes

These urethane foam tapes are soft, conformable and offer excellent shear adhesion which makes them ideal for a wide range of general purpose mounting and joining applications. The acrylic adhesive forms long-aging bonds to many surfaces. Application ideas include mounting of mirrors, interior signs and wire/cable clips. The individually boxed short rolls are ideal for maintenance, repair and operation needs.



Part Number	Product Number	Thickness	Roll Size	Rolls/Case
Bulk				
051131- 06439	4008	1/8"	1" x 4 yds.	5
021200- 06452	4008	1/8"	1" x 36 yds.	9
021200- 06455	4016	1/16"	1" x 36 yds	9
051131- 06440	4026	1/16"	1" x 6 yds.	5
021200- 06458	4032	1/32"	1" x 36 yds.	9

3M™ Double-Coated Urethane Foam Tapes

A black, conformable, urethane foam with a long-aging, high-shear adhesive on both sides. These tapes offer high internal strength with a wide temperature range (-40°F to 225°F). For general purpose mounting and joining or applications where cold temperature performance is required. Applies to most clean, dry unified surfaces; rough surfaces, too.



Part Number	Product Number	Size	Rolls/Case
021200- 14557	4052	1" x 1/32" x 72 yds.	9
021200- 14558	4056	1" x 1/16" x 36 yds.	9

3M™ Urethane Foam Tapes

An open cell low density charcoal gray polyester urethane with a pressure-sensitive acrylic adhesive on one side. This adhesive has excellent long-term aging, and ultimate high bond strength to a variety of surfaces as well as high temperature performance. Applications include gasketing and sealing for dust and light and damping and cushioning for sound and vibration.



Part Number	Product Number	Size	Rolls/Case
051131- 06443	4314	1" x 1/4" x 18 yds.	9
051131- 06446	4317	1" x 3/8" x 9 yds.	9

3M™ Adhesion Promoter

A liquid primer packaged in convenient, single-use applicator packets. Can be applied on common low-surface energy plastics used for dash and interior trim applications. One packet covers approximately 150 square inches of substrate at the recommended coating thickness.



Part Number	Size	Each/Box	Rolls/Case
051131- 06396	2.5cc	25	4

Foam and Paper Tapes

Scotch® Double-Coated 1/4" Urethane Foam Tape — No. 4004

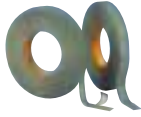

A high density, urethane foam, with a long-aging acrylic adhesive on both sides. Treated green plaid paper liner. For a multitude of mounting and holding jobs. Applies to most clean, dry, unified surfaces, rough surfaces, too. Functions for extended periods at 225°F under conditions of proper loading. Provides thermal insulation; reduces vibration transmission.

Part Number	Size	Rolls/Case
021200-03394	1" x 1/4" x 18 yds.	9

3M™ Double-Coated Vinyl Foam Tape — No. 4408



A black vinyl foam with long-aging adhesive on both sides. Treated green plaid paper liner. For a multitude of mounting and holding jobs while providing one-piece removal in most instances. Applies to most clean, dry, unified surfaces; rough surfaces, too. Functions for extended periods at 120°F. Provides thermal insulation. Reduces vibration transmission.

Part Number	Size	Rolls/Case
021200-03291	1" x 36 yds.	9

3M™ Vinyl Foam Tape



A black vinyl foam with a long-aging adhesive on one side. Used for a variety of sealing, gasketing and vibration damping applications. For clean, dry, unified and rough surfaces too. Excellent for use in hatch cover weatherstripping.

Part Number	Product Number	Thickness	Size	Rolls/Case
Bulk				
021200-03314	4508	1/8"	1" x 36 yds.	9
021200-03318	4504	1/4"	1/2" x 18 yds.	18
021200-03319	4504	1/4"	3/4" x 18 yds.	12
021200-03320	4504	1/4"	1" x 18 yds.	9

3M™ VHB™ Acrylic Foam Tapes — No. 4930, 4950









White closed cell acrylic foams with high-strength, long-aging acrylic adhesive on both sides. They have excellent immediate tack and feature the highest peel strengths available in a pressure-sensitive system. Available in 25 mils and 45 mils with treated paper liner. Primary applications are industrial assembly as an alternative to mechanical fasteners and liquid adhesives. The totally unique acrylic foam adds a new dimension to conformability without increasing the thickness.

Part Number	Product Number	Size	Thickness	Rolls/Case
021200-18088	4930	1" x 72 yds.	25 mils	9
021200-18092	4950	1" x 36 yds.	45 mils	9

3M Marine “Preferred” Masking Film and Papers

Application Guide

	Mask Film	ScotchBlok Paper	Steel Gray Paper	White Paper	Utility Green Paper	Overspray Sheeting
						
Critical Masking (Spraying)	■	■	■			
General Purpose Masking (Brushing or Rolling)	■	■	■	■		
Utility Masking (Brushing or Rolling)	■	■	■	■	■	
Indoor Masking	■	■	■	■	■	■
Outdoor Masking		■	■	■	■	
Conformable	■	■		■		■
Durable	■	■				■
Attracts and Holds Material	■	■				■
Overspray Protection	■	■	■	■	■	■

3M Masking Paper

3M™ ScotchBlok™ Masking Paper

3M’s “Preferred” critical masking paper. 3M™ ScotchBlok™ Masking Paper is a tightly-bonded, specially-coated masking paper specifically manufactured for the marine aftermarket. This superior masking paper offers the ultimate penetration resistance from all solvents used in today’s gelcoat and paint systems. 3M ScotchBlok masking paper’s bonded fiber formation reduces contamination of freshly painted and varnished surfaces and provides excellent conformability and holds up well under wet sanding conditions. Distinctive gold color for easy identification.



Part Number	Color	Size	Rolls/Case
051131- 06706	Gold	6" x 750'	6
051131- 06712	Gold	12" x 750'	3
051131- 06718	Gold	18" x 750'	2
051131- 06736	Gold	36" x 750'	1
051131- 06732	Gold	12" x 180'	12
051131- 06738	Gold	18" x 180'	12

Scotch® Steel Gray Masking Paper

3M’s “Better” critical masking paper. A steel gray-colored specially processed high-density paper with excellent penetration resistance designed for exacting requirements of paint masking.



Part Number	Color	Size	Rolls/Case
021200- 06503	Steel Gray	3" x 1000'	6
021200- 06506	Steel Gray	6" x 1000'	6
021200- 06509	Steel Gray	9" x 1000'	4
021200- 06512	Steel Gray	12" x 1000'	3
021200- 06518	Steel Gray	18" x 1000'	3
021200- 06524	Steel Gray	24" x 1000'	2
021200- 06536	Steel Gray	36" x 1000'	1

3M Masking Paper

3M™ White Masking Paper

3M's "Good" critical masking paper. 3M™ White Masking Paper is specifically manufactured for the marine aftermarket. It offers good protection against bleed-thru from gelcoat and urethane, enamel and lacquer paint systems. The tightly bonded paper protects against fiber contamination and conforms easily to irregular surfaces.



Part Number	Color	Size	Rolls/Case
051131- 06508	White	12" x 180'	12
051131- 06537	White	6" x 750'	6
051131- 06538	White	12" x 750'	3
051131- 06539	White	18" x 750'	2
051131- 06540	White	36" x 750'	1

3M™ Utility Grade Masking Paper (Green)

This masking paper is designed for non-critical masking applications or when paint is applied by brush or roller. This paper is not generally recommended for spray painting applications.



Part Number	Color	Size	Rolls/Case
051131- 77401	Green	3" x 60 yds.	12
051131- 77402	Green	6" x 60 yds.	12
051131- 77403	Green	9" x 60 yds.	12
051131- 77399	Green	12" x 60 yds.	12
051131- 77400	Green	15" x 60 yds.	12
051131- 06904	Green	18" x 60 yds.	12

3M Masking Film

3M Masking Films are high-density, non-porous plastic films specially designed for paint masking and paint overspray protection. These films are for indoor or very limited outdoor use only. At earliest opportunity, remove plastic films from gelcoat or painted surfaces to eliminate moisture from getting trapped between plastic and substrate. Trapped moisture may inhibit curing and plastic film may "imprint" on surface.

3M™ HandMasker™ Pre-Folded Masking Film Rolls

3M's "Preferred" critical indoor masking film. These rolls are pre-folded and will fold down to various widths. Plastic films are not for extended outdoor use. The 9" x 100' roll folds down to 72" width and 12" x 100' roll folds down to 99" width to offer paint overspray protection for larger surface areas on deck or hull.



Part Number	Description	Size	Rolls/Case
051131-06848	MF-48	48" x 180'	6

Part Number	Description	Blades/Roll
051131-06802	12" Masking Film Cut-Off Blade	6

Part Number	Description	Size	Rolls/Case
051131-06845	MF-24	24" x 180'	12
051131-77406	MF-72	72" x 90'	12
051131-77407	MF-99	99" x 90'	12

3M™ HandMasker Pre-taped Film with Scotch-Blue™ Painter's Tape for Multi-Surfaces — No. 2090



A convenient specially treated pre-taped plastic film that unfolds and clings to surfaces to protect from paint, splatter, and overspray. The painter's tape removes cleanly for up to 14 days.

Part Number	Size	Rolls/Case
051131-06696	24" X 30 yds.	12
051131-06697	35" X 25 yds.	12

3M™ HandMasker™ Pre-Loaded Dispensers

A convenient specially treated pre-taped plastic film that unfolds and clings to surfaces to protect from paint, splatter, and overspray. The painter's tape removes cleanly for up to 14 days.

Part Number	Size	Rolls/Case
051115-07997	24" X 30 yds. with Dispenser	12

3M™ HandMasker™ M3000FTK Film Tape Kit



Kit includes M3000 dispenser with multi-purpose hook, 1 roll of Scotch-Blue™ Painter's Tape for Multi-Surfaces 2090, 1 roll of MF48 48" x 180' pre-folded film and 1 FB12 12" film blade.

Part Number	Kits Per Case
051131-79284	12

3M™ HandMasker™ M2000FTK Film Tape Kit



Kit includes M2000 dispenser with multi-purpose hook, 1 roll of Scotch-Blue™ Painter's Tape 2090, 1 roll MF24 24" x 180' pre-folded masking film and 1 FB6 6" film blade.

Part Number	Kits Per Case
051131-79283	4

3M Masking Film

3M™ Hand-Masker™ Pre-taped Drop Cloth

When it comes to protecting surfaces from paint drips, splatter and overspray, 3M™ Hand-Masker™ Pre-taped Drop Cloths have it covered. No matter how large or small the area to cover, there's a pre-taped drop cloth ideal for the job. Benefits: pre-taped to make masking an easy, one-step job; Each unfolds to protect and cover both large and small areas; Two kinds of tape for different masking conditions; Scotch® Painters' Masking Tape No. 2090 is sunlight and UV-resistant for clean removal for up to 14 days – even on glass exposed to direct sunlight; Made of film for easier clean-up than conventional drop cloths. Product Number indicates which tape is included, and those with "D" indicates the roll comes with a dispenser. **Plastic films are not for extended outdoor use.**

Part Number	Product Number	Roll Size	Rolls/Case
051131-80058	PTD2090-48	48" X 30 yds.	6
051131-80055	PT2090-48	48" X 30 yds.	8
051131-80053	PTD2020-72	72" X 25 yds.	6
051131-80052	PT2020-72	72" X 25 yds.	8
051131-80056	PTD2020-99	99" X 50'	6
051131-80054	PT2020-99	99" X 50'	8

3M™ Overspray Protective Sheeting

A high density, tear resistant, clear film that is treated on both sides for excellent paint overspray adhesion. Twelve-foot film folded to three feet for easy one-person application. Sixteen foot width accommodates larger surface areas for more effective overspray protection. Use with 3M™ Overspray Protective Sheeting Masker (PN06780).



Part Number	Size	Rolls/Case
051131-06727	12' x 400' Clear (Folds down to 3')	1
051131-06728	16' x 400'	1

3M™ Overspray Protective Sheeting Masker

A portable masker designed to dispense 3M™ Overspray Protective Sheeting (PNs 06727 and 06728). It can be used horizontally, vertically or wall mounted. The spring-loaded end frame is designed for easy loading of Overspray Protective Sheeting. **NOTE: PROTECTIVE SHEETING IS NOT INCLUDED WITH THE MASKER.**

Part Number	Masks/Case
051131-06780	1

Maskers

3M™ Hand-Masker™ M3000 Kit

This kit consists of the 3M™ Hand-Masker™ M3000 Dispenser with multi-purpose hook, a 12" masking film cut-off blade and the 3M™ Hand-Masker™ Tack-Down Tape Dispenser. **NOTE: MASKING PAPER NOT INCLUDED WITH KIT.**



Part Number	Kits/Case
051131-06788	4

3M™ Hand-Masker™ M2000 Dispenser

This dispenser applies masking tape to masking film (up to 72") or masking paper (up to 12"). A convenient wrist strap lets you free your hands and can be used to hang the dispenser on a hook. The M2000 dispenser is the choice for light-duty masking.



Part Number	Dispensers/Case
051131-77384	4

3M™ Hand-Masker™ Dispenser M3000

Applies masking tape to masking film (up to 144") or paper (up to 18") in one continuous application. Compact, lightweight, saves time. For professional heavy duty use.



Part Number	Dispensers/Case
051131-77385	4

3M™ Hand-Masker™ Dispenser Cut-Off Blades

These 3M™ Cut-Off Blades are designed for use in conjunction with the 3M™ Hand-Masker™ Dispenser Model M-3X III.



Part Number	Size	Blades/Case
051131-06794	6"	6
051131-06795	9"	6
051131-06796	12"	6
051131-06804	6"	6

Masks

3M™ Hand-Masker™ Tack-Down Tape Dispenser

This accessory attachment for the 3M™ Hand-Masker™ Dispenser accommodates an additional roll of masking tape for tacking down the loose end of masking paper during masking applications. **NOTE: MASKING PAPER NOT INCLUDED WITH DISPENSER ATTACHMENT.**



Part Number	Dispensers/Case
051131-06787	6

Scotch® DT30 Dual-Tac™ Tape

Apply to masking tape to hold poly and untaped edges of masking film.



Part Number	Color	Size	Rolls/ Pack	Packs/ Case
051131-76741	Orange	3/4" x 60 yds.	6	4

Masking Machines

Scotch® Cart Masker

Dispenses one roll of masking paper up to 18" on each of the two levels. This masker has large, deep storage trays on the top and bottom. The narrow width, large handle, and 8" wheels make moving it very easy. In addition, this masker has a built in storage rack for spray guns, and two hooks for Scotch® Paint Masking Tape – No. 233, or Scotch® Plastic Tape – No. 471, Blue. It is very easy to assemble. **NOTE: MASKING PAPER NOT INCLUDED WITH MASKER.**



Part Number	Masks/Case
051131-06781	1

Scotch® Tray Masker

Dispenses single rolls of masking paper. Built into the top is a handy large storage tray. This masker can be wall mounted. It is very easy to assemble. Available in either an 18" or 36". **NOTE: MASKING PAPER NOT INCLUDED WITH MASKER.**



Part Number	Maximum Width of Masking Paper	Masks/Case
051131-06783	36"	1
051131-06784	18"	1

Scotch® Slimline Apron Taper

Dispenses three rolls of masking paper up to widths of 18" and can be easily moved from job to job with one-hand mobility. It maintains proper tape and paper alignment and doesn't require adjusting. **NOTE: MASKING PAPER NOT INCLUDED WITH TAPER.**

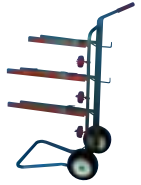

Part Number	Tapers/Case
021200-06864	1

Scotch® Apron Taper – 18"

Masking jobs are faster and easier with this unit that dispenses single paper aprons through 18" wide or adapts for most combinations up through 18" with conversion kit. **NOTE: MASKING PAPER NOT INCLUDED WITH TAPER.**



Part Number	Tapers/Case
021200-06865	1

Scotch® Apron Taper – 36"

Dispenses single aprons through 36" width or adapts for any combination of two paper widths up through 36". **NOTE: MASKING PAPER NOT INCLUDED WITH TAPER.**



Part Number	Tapers/Case
021200-06866	1

Masking Machines

Scotch® Multi Mobile Masker

The complete masker that reduces labor costs. It's fast and convenient. Two-roll capacity with top and bottom dispensing system. Dispenses single aprons through 18" wide. Laminates tape to paper as paper is dispensed. It comes easy to assemble – insert two bolts to complete frame and four bolts to mount lower cutting blade. **NOTE: MASKING PAPER NOT INCLUDED WITH MASKER.**



Part Number	Masksers/Case
051131-06869	1

Scotch® Mobile Frame

Designed to have the Scotch® Apron Taper (PN06866) added to the top, this frame is for those wishing to build a mobile 36" dispenser. Preassembled except for insertion of two bolts to make frame operative.



Part Number	Frames/Case
021200-06871	1

Welding Drape

3M™ Welding and Spark Deflection Paper

A flame retardant deflection paper formulated to protect vertical surfaces, glass and paint from welding splatter and grinding sparks. Comes in an easy-to-use roll form with repositionable adhesive on one side.

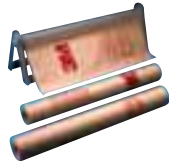

Part Number	Roll Size	Rolls/Case
051131-05916	24" x 150'	2

3M™ Welding and Spark Deflection Dispenser

This dispenser is designed for use with single rolls of 24" 3M™ Welding and Spark Deflection Paper (PN05916). It is very easy to assemble and can be wall or table mounted.

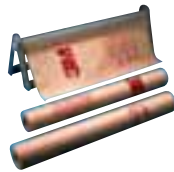

Part Number	Dispensers/Case
051131-05912	2







3M™ High Performance Welding Drape

A unique construction of 100% carbon fiber. This sets this product apart from others used to protect surfaces from spark and weld splatter. Exceptional wear and tear resistance makes this drape one that won't need to be replaced as often. At 57" x 80", it is the optimal size for local protection. Packed one blanket per case; each drape is packed in an upgraded zippered vinyl bag for storage.



Part Number	Size	Drapes/Case
051131-05919	57" x 80"	2

3M Marine Adhesives and Sealants

						
	5200	5200FC	4200	4200 UV	101	Silicone
Adhesive or Sealant	Both	Both	Both	Both	Sealant	Sealant
Above/Below Waterline	Both	Both	Both	Both	Both	Above
Strength	High	High	Medium	Medium	Medium	Low
Allows for Disassembly	No	No	Yes	Yes	Yes	Yes
“Skin Over” or Track Free Handling	48 Hours	1-2 Hours	1-2 Hours	1-2 Hours	5 Hours	5-10 Minutes
Cure Time	5-7 Days	24 Hours	24 Hours	24 Hours	14-21 Days	24 Hours
Cosmetic	No	No	No	Yes	No	No
Mechanical Fasteners Needed	No	No	Yes	Yes	Yes	Yes
Solvent-Resistance	No	No	No	No	Yes	No
Color	White, Black, Tan, Mahogany	White	White, Black	White	White	White, Clear

3M Marine Products

Adhesive Sealant Selection Chart



Applications	3M™ Marine Adhesive Sealant 5200	3M™ Marine Adhesive Sealant Fast Cure 5200	3M™ Marine Adhesive Sealant Fast Cure 4200	3M™ Marine Adhesive Sealant Fast Cure 4200 UV	3M™ Marine Sealant 101	3M™ Marine Sealant Silicon
Wood to:						
Metal (Deck/Hull Hardware)	■	■	■	■ ■	■	■
Wood (Wood Trim)	■ ■	■ ■	■	■	■	■
Thru-Hull Fastening (Wooden Boat)	■ ■	■ ■	■	■	■	■
Glass (sealing only)	NR	NR	NR	■	■	NR
Lexan™ Plastic	NR	NR	NR	■	NR	NR
Plastic Hardware (ABS, Nylon)	■	■	■ ■	■ ■	■ ■	■
Rub Rails	■	■	■ ■	■ ■	■ ■	■
Fiberglass to:						
Metal (Deck/Hull Hardware)	■	■	■	■ ■	■	■
Wood (Wood Trim)	■ ■	■ ■	■ ■	■ ■	■	■
Thru-Hull Fastening (Wooden Boat)	■ ■	■ ■	■	■	■	NR
Glass (sealing only)	NR	NR	NR	■	■	■
Lexan™ Plastic	NR	NR	NR	■	NR	■ ■
Plastic Hardware (ABS, Nylon)	■	■	■ ■	■	■ ■	■
Rub Rails	■	■	■ ■	■ ■	■ ■	■
Glass (sealing only) to:						
Metal (Windshields)	NR	NR	NR	■	■	■
Vinyl	NR	NR	NR	■	NR	■
Other:						
Deck to Hull Joints	■ ■	■ ■	■	■	NR	NR
Attributes:						
Sandable (Y=Yes, N=No)	Y	Y	Y	Y	Y	N
Chemical Resistant (Y=Yes, N=No)	N	N	N	N	Y	Y
Cure Rate (F=Fast, S=Slow)	S	F	F	F	S	F
Available Colors	White, Black, Tan, Mahogany	White	White, Black	White	White	White, Clear
Discoloration Resistance	■	■	■	■ ■	■	■ ■

NR=Not Recommended

Coverage Charts for Adhesive Sealant Products

Given the desired diameter of a bead or the dimensions of a seam, the coverage obtained from a cartridge can be looked up in the following charts. Note that the values are calculated for "no waste". The actual coverage will be based on application technique and overfill.

Bead Diameter (inch)		Length of Bead (lineal feet)	
Fractional	Decimal	for 10 fl. oz.	for 3 fl. oz.
1/8"	0.125	126.2	37.8
1/4"	0.250	31.6	9.4
3/8"	0.375	14.0	4.2
1/2"	0.500	7.9	2.3

To find out more about these and other great 3M Marine Products, please call 1-877-366-2746, or visit www.3M.com/marine.

Square Foot Area Coverage

Should it be necessary to cover an area with the adhesive sealant, the material should be dispensed from the container and spread with a trowel. Most trowels for spreading adhesives will have a notched edge to facilitate control of the thickness being applied. When the notch depth is known or can be measured, the coverage area can be determined from the following tables. Should it be necessary to apply a solid layer of a specific thickness, take the value given in the following table and divide the area by two.

Package Size	Notch Depth (inch)			
	1/16"	1/8"	3/16"	1/4"
1 oz. Tube	0.4	0.2	0.1	0.1
3 oz. Tube	1.2	0.6	0.4	0.3
10 oz. Cartridge	4.0	2.0	1.3	1.0
5 Gallon Pail	256	128	86	64

Adhesives/Sealants

3M™ Marine Adhesive/Sealant 5200

High performance, one-part polyurethane. Extremely strong and retains its strength above or below the waterline. Stays flexible. Watertight bonding/sealing of fiberglass, gelcoat and wood. Ideal for through-hull fastening, deck fittings, railings and transducers. Best when no removal is anticipated.



Part Number	Color	Container Size	Each/Case
Tubes – Carded			
051135-05203	White	3 oz.	6
051135-05205	Black	3 oz.	6
051135-05206	White	1 oz.	12
Cartridges			
051135-06500	White	1/10 Gallon	12
051135-06501	Tan	1/10 Gallon	12
051135-06502	Mahogany	1/10 Gallon	12
051135-06504	Black	1/10 Gallon	12
Pails			
021200-05206	White	5 Gallon	1

3M™ Marine Adhesive/Sealant Fast Cure 5200

Faster curing version of 3M™ Marine Adhesive Sealant 5200. Extremely strong and retains its strength above or below the waterline. Stays flexible. Watertight bonding/sealing of fiberglass, gelcoat and wood. Ideal for through-hull fastening, deck fittings, railings and transducers. Best when no removal is anticipated.



Part Number	Color	Container Size	Each/Case
Tubes – Carded			
051135-05220	White	3 oz.	6
Cartridges			
051131-06520	White	1/10 Gallon	12

3M™ Marine Adhesive/Sealant Fast Cure 4200

A one-part general purpose polyurethane that delivers strong, flexible bonds. Bonds and seals fiberglass, gelcoat and wood. Ideal for rub-rails, stern-joints, deck and through-hull fittings, and access plates. Medium strength allows for disassembly.



Part Number	Color	Container Size	Each/Case
Tubes – Carded			
051135-05260	White	3 oz.	6
Cartridges			
051135-06560	White	1/10 Gallon	12
051135-06564	Black	1/10 Gallon	12

3M™ Marine Adhesive/Sealant Fast Cure 4000UV

A one-part polyether formula that has superior U.V. resistance and cures to form a firm, rubbery, watertight seal. Remains flexible. Bonds and seals metal, gelcoat, fiberglass, wood and plastic. Ideal for deck hardware, hatches, portholes, transducers, railings and navigation lights. Great for visible bond lines.



Part Number	Container Size	Each/Case
051135-06580	1/10 Gallon	12
051135-06586	400ml Flex Pack	12
051135-05280	3 oz.	6

3M™ Marine Sealant 101

A high-quality polysulfide sealant that cures a firm, flexible rubbery seal with excellent waterproofing qualities. Seals fiberglass, wood, metal, glass and plastic. Ideal for Bedding hardware, moldings and hatches.



Part Number	Color	Container Size	Each/Case
Cartridges			
051135-06510	White	1/10 Gallon	12

Adhesives/Sealants

3M™ Marine Grade Silicone Sealant

This high quality silicone is designed for the harsh marine environment. It forms a mildew-resistant, non-yellowing seal that remains flexible even after years of exposure.



Part Number	Color	Container Size	Each/Case
Tubes – Carded			
051135-08017	White	3 oz.	6
051135-08019	Clear	3 oz.	6
Cartridges			
051135-08027	White	1/10 Gallon	12
051135-08029	Clear	1/10 Gallon	12

Coverage Calculator Table

Given the **seam dimensions**, chart provides lineal feet per cartridge (assumes no waste).

Depth	Width				
	1/8"	3/16"	1/4"	5/16"	3/8"
1/8"	96.3	64.2	48.1	38.5	32.1
3/16"	64.2	42.8	32.1	25.7	21.4
1/4"	48.1	32.1	24.1	19.3	16.0
5/16"	38.5	25.7	19.3	15.4	12.8
3/8"	32.1	21.4	16.0	12.8	10.7
7/16"	27.5	18.3	13.8	11.0	9.2

3M Adhesive Sealant Accessories

3M™ Cartridge Applicator Gun

1/10 gallon cartridge gun for use with adhesive, sealants and glazing compound cartridges.



Part Number	Each/Case
051135-08992	12

3M™ Professional Caulking Gun

A high-performance gun, designed for the professional, to be used for dispensing 1/10 gallon sized cartridges.



Part Number	Each/Case
051135-08993	1

3M™ Flexible Package Applicator Gun

A fully enclosed, all metal, rod driven, friction feed applicator gun for use with all 310ml or smaller foil flexible packages.



Part Number	Size	Each/Case
051135-08398	400ml	2

3M™ Flex Pack Heavy Duty Applicator Gun

A fully enclosed, all metal, rod driven, friction feed gun. For use with 400ml foil flexible packages. Ideal for use with 3M™ Marine Adhesive Sealant Fast Cure 4000UV (PN06586).



Part Number	Size	Each/Case
051135-08991	400ml	2

3M Sealers, Coatings and Adhesives Organizer

This organizer has one door which opens either on the right or on the left, is lockable and can be hung on a wall or placed on a shelf. It measures 30-1/8" high, 14-1/8" wide and 12-1/8" deep and is made of sturdy 24 gauge American steel. The weight is 26 pounds. Not a 3M product. To order, call Shopware at 1-800-877-9344. **NOTE: PRODUCT IS NOT INCLUDED WITH THE ORGANIZER.**



Part Number	Description	Each/Case
051131-02508	Right Side (door opens on left)	1

* Not stocked as a 3M item.

Adhesives

3M™ Super Weatherstrip Adhesive

For adhering all types of weatherstrip to doors. Light colored, very fast drying, exceptional bonding strength. Used as a gasket adhesive on engines.



Part Number	Container Size	Tubes/Case
051135-08001	5 oz. Tube	6

3M™ Weatherstrip Adhesive — Black

For bonding trim fabrics (except vinyl), deck mats and rugs, etc. Also good general cement. Has quick tack and will not bleed through fabric.



Part Number	Color	Container Size	Tubes/Case
051135-08011	Black	5 oz. Tube	6

3M™ Fast Tack Adhesive

A light-colored, extremely fast-drying, non-stain adhesive with long tack for attaching vinyl and other kinds of trim fabric, upholstery, floor mats and carpeting.



Part Number	Container Size	Tubes/Case
051135-08031	5 oz. Tube	6

3M™ Feathering Disc Adhesive Type II

Specially formulated to allow multiple disc applications without adhesive buildup or paper delamination. Discs remove easily and cleanly.



Part Number	Container Size	Tubes/Case
051135-08051	5 oz. Tube	6

3M™ Scotch-Seal™ Metal Sealant 2084

An aluminum colored, general purpose, medium viscosity sealant with good adhesion to aluminum and glass. Ideally suited for beading glass in aluminum window channels.



Part Number	Container Size	Tubes/Case
021200-20227	5 oz. Tube	6

3M™ Ultrapro™ High Temp Silicone Gasket

Premium grade compound for form-in-place gasketing. Range from -20°F to 600°F. Oxygen sensor safe.



Part Number	Color	Container Size	Tubes/Case
051135-08672	Black	3 fl. oz. Tube	6

3M™ Structural Adhesive Kit

A two-part general purpose gray adhesive that may be used for miscellaneous fiberglass repair and bonding trim ornaments.



Part Number	Container Size	Kits/Case
051135-08101	2-2 fl. oz./kit	6

3M™ Quick Fix Adhesive (Cyanoacrylate)

A strong, rapid-bonding, convenient-to-use adhesive. It has excellent adhesion to most rubber, weatherstripping, vinyl, metals, glass, wood and plastics as well as excellent resistance to temperature extremes, shock and most marine chemicals and fluids.



Part Number	Container Size	Bottles/Case
051135-08155	1 oz. Bottle	12

3M™ Strip-Calk

For sealing openings where a soft, non-hardening material is needed. Good for use in seams and under deck hardware. 3M™ Strip-Calk is waterproof, will not shrink, can be painted and requires no application tools. Each box contains 60, 1 ft. lengths.



Part Number	Color	Containers/Case
051135-08578	Black	12

3M™ Automix™ Fast Cure Epoxy Adhesive — Clear

A super strong two-part epoxy for bonding metal, glass, plastic, wood and fiberglass. Adhesive is conveniently dispensed by the 3M™ Automix™ Applicator Gun (PN08191).



Part Number	Duo-Packs/Case
051135-08107	6

3M™ Heavy Duty 2 oz. Automix™ Applicator Gun

Designed for use with all 2 oz. 3M™ Automix™ products.



Part Number	Each/Case
051135-08191	1

Aerosol Adhesives

3M™ Spray Trim Adhesive

A transparent, extremely fast drying adhesive with long tack for attaching upholstery cloth, floor mats, carpeting, etc. to painted or bare metal, wood, KB board or other trim materials. May also be used to bond styrofoam.



Part Number	Container Size	Cans/Case
051131-08074	24 oz. Aerosol	6

3M™ General Trim Adhesive – Clear, Low VOC

A fast-drying, high-strength, 50% VOC clear adhesive in an aerosol container. Designed for bonding most types of trim used in boat trim except unsupported vinyl. Excellent for fabrics, upholstery foam, carpets. Do not use on styrofoam.



Part Number	Container Size	Cans/Case
051131-08088	24 oz. Aerosol	4

3M™ Super Trim Adhesive

A fast-acting, high-strength, aerosol contact adhesive designed for two-surface application. This adhesive is resistant to heat and plasticizing oils and is excellent for attaching vinyl, insulation, foam, padding and rubber parts to metal and other surfaces. Bonds can be made within minutes of application or as long as one hour later.



Part Number	Container Size	Cans/Case
051131-08090	24 oz. Aerosol	6

3M™ Super 77 Spray Adhesive Low Mist

Reformulated to reduce misting and VOC emissions while increasing adhesive coverage. A high-tack, high-coverage, fast-drying, transparent adhesive for permanently attaching foils, carpeting, foams, paper, cardboard, felt, cloth, etc. to painted or unpainted metals, wood, hardboard, and other base materials. Features: convenient, fast, easy application; high coverage, aggressive high tack, long bonding range; two actuators, one actuator for standard spray pattern, second actuator for wide spray pattern; excellent spray control, uniform spray coat, high initial "grab" with sufficient open time to allow for positioning of materials. Contains no methylene chloride, 1,1,1-trichloroethane or chlorofluorocarbons.



Part Number	Container Size	Cans/Case
021200-21210	24 oz. Aerosol	12

3M™ High-Strength Adhesive 90

The fastest drying, high-strength aerosol contact adhesive that 3M offers. Drying in just one to two minutes, substrates that are to be bonded can be assembled faster for improved productivity. Bonds difficult substrates including: polyethylene, polypropylene, many other plastics. Comes with an adjustable tip that allows the selection of a 1 to 3 inch spray width to match any application requirement. Contains no methylene chloride, 1,1,1-trichloroethane or chlorofluorocarbons.



Part Number	Container Size	Cans/Case
021200-30023	24 oz. Aerosol	12

3M™ High Tack Adhesive 76

A high-tack adhesive with fast strength build-up. Used by sailmakers when tacking parts of sails together prior to sewing. Apply to one surface. It comes out of the can in a "lace" spray for more control. Also attaches nameplates and swimming pool liners.



Part Number	Container Size	Cans/Case
021200-30026	24 oz. Aerosol	12

3M™ Foam Fast Adhesive 74

Excellent aerosol adhesive for general upholstery form bonding. Its characteristics include: fast tack; foam tearing strength; soft, non-dimpling glue line; non-misting; precise spray control and variable width spray. Applications include forming foam shapes by knife edge bonding, boxing and edge turning and attaching foam to metal. Contains no methylene chloride, 1,1,1-trichloroethane or chlorofluorocarbons.



Part Number	Container Size	Cans/Case
021200-82242	24 fl. oz.	12

3M™ Industrial Spray Adhesive

An economical, industrial grade, general purpose aerosol adhesive. It bonds a wide variety of lightweight materials including paper, cardboard, plastic films, foam, and fiberglass insulation.

Part Number	Container Size	Containers/Case
021200-87998	24 fl. oz.	12

Aerosol Adhesives

Scotch-Weld™ Structural Plastic Adhesive DP-8005 and DP-8010

Two-part acrylic based adhesives (10:1 ratio by volume) that can bond many low surface energy plastics, including many grades of polypropylene, polyethylene and TPO's without special surface preparation. Especially effective with marine King Starboard® applications. Difference in the two products is their open time: DP-8005 has an open time of 5 minutes, and DP-8010 has an open time of ten minutes. Both products can replace screws, rivets, plastic welding, and two-step processes which include chemical etchants, priming or surface treatments in many applications.

Important: For the 35ml size, use only the specified 3M™ EPX Plus II Applicator System (PNs 50004 or 50007) or the appropriate meter mix equipment to ensure the proper 10:1 mix ratio and mix. Hand mixing is not recommended as it may produce unpredictable results.

Part Number	Product	Size	Open Time	Each/Case
021200-45167	DP-8005 Black	35ml	5 min.	12
021200-41547	DP-8005 Translucent	35ml	5 min.	12
021200-41548	DP-8005 Translucent	250ml	5 min.	12
021200-49110	DP-8010	35ml	10 min.	12
021200-96309	DP-8010 NS (non-sag)	35ml	10 min.	12

3M™ Scotch-Weld™ EPX™ Plus II Applicator W 2:1 and 1:1 Plunger Model 9170

This plunger is for the 3M™ Scotch-Weld™ EPX™ Plus II Applicator. The EPX Plus II Applicator is used to dispense 3M™ Scotch-Weld™ adhesives in duo-pak cartridges.

Part Number	Description	Quantity/Case
021200-50004	10:1 Ratio	10
021200-50007	Nozzle	10

3M™ Fastbond™ 10 Contact Adhesive – Neutral

A brushable, air-drying, neutral-colored contact adhesive used for bonding decorative laminates, aluminum, steel, wallboard, plywood, panels, wood and wood veneer, rubber, canvas and other porous and non-porous materials to each other or to themselves. Bonds immediately and permanently upon application eliminating the need for clamping or fixturing the materials being bonded. Offers exceptional high-bond strength and superior resistance to heat and sunlight.



Part Number	Container Size	Containers/Case
021200-20272	1 Quart	12
021200-20274	1 Gallon	4

3M™ Fastbond™ 30NF Contact Adhesive – Neutral

A water dispersed, high-strength, non-flammable contact adhesive. Has high-coverage, a long-bonding range, and good heat resistance. Used to bond plastics, plastic laminate, wood, plywood and wood veneer and canvas to themselves and to each other.



Part Number	Container Size	Containers/Case
021200-21180	1 Quart	12
021200-21181	1 Gallon	4
021200-21182	5 Gallon Pail	1
021200-21183	55 Gallon Drum (Open Head)	1

3M™ General Purpose Adhesive Cleaner

A specially blended solvent that provides easy cleanup of most types of adhesives, and quickly removes waxes, greases, oil and tars. When properly used, it will not harm thoroughly dried paint, vinyl or fabrics.



Part Number	Container Size	Containers/Case
051135-08984*	1 Quart Can	6
051135-08986*	5 Gallon Pail	1
051135-08987	20 oz. Aerosol Can	12

* This product cannot be purchased for use in Southern California per the California South Coast Air Quality District Rule 1171.

3M™ Citrus Base Cleaner

A multi-purpose cleaner which will dissolve and flush away dirt, grease, tar, most non-curing type adhesive films, and similar substrates. It is a citrus oil based cleaner that emulsifies when flushed with water and contains no petroleum distillates. Use it to clean and degrease metal parts, motors, tools, and concrete. Contains no ozone depleting chemicals.



Part Number	Container Size	Containers/Case
021200-76394	24 fl. oz.	12

Bulk Adhesives

Scotch-Grip™ Industrial Adhesive 4491

A light tan, sprayable, fast drying adhesive with good resistance to plasticizer migration. Formulated to be a HAPS free and SCAQMD Rule 1168 compliant solvent based adhesive. Ideal for bonding many vinyl extrusions and sheeting. Bonds made with it exhibit high strength and resistance to weathering, water, oil and many solvents.

Part Number	Container Size	Containers/Case
021200- 50046	5 Gallon Pail	1
021200- 50045	55 Gallon Pail	1

3M™ Super 77 Adhesive (Bulk)*

A bulk version of 3M Brand Super 77 Spray Adhesive. A high tack, high coverage, fast drying, transparent adhesive for permanently attaching foils, carpeting, many lightweight foams, paper, cardboard, felt, and cloth to painted or unpainted metals, wood, hardboard, and other base materials. Some of the features are: high coverage, aggressive high tack, and long bonding range. It provides high initial "grab" with sufficient open time to allow for positioning of materials.



Part Number	Container Size	Containers/Case
021200- 43798	1 Gallon	4
021200- 43793	5 Gallon Pail	1
021200- 43813	55 Gallon Drum	1

*Not for sale in California.

3M™ Hi-Strength 90 Adhesive (Bulk)*

A bulk version of 3M Brand Hi-Strength 90 Spray Adhesive. A high strength, fast, contact-type adhesive. It has fast contact strength buildup for many decorative laminates, yet only needs one or two minutes of drying time. Excellent adhesive for decorative laminates, particleboard, and many other materials, even polyethylene, polypropylene, and SBR rubber.



Part Number	Container Size	Containers/Case
021200- 43799	1 Gallon	4
021200- 43797	5 Gallon Pail	1
021200- 43814	55 Gallon Drum	1

*Not for sale in California.

3M™ Hi-Strength 90 Cylinder Spray Adhesive*

3M™ Hi-Strength 90 Cylinder Spray Adhesive applies translucent adhesive in a controlled lace pattern. For two-surface bonding only. Bonding within 15 minutes is recommended. Forms a permanent bond with typical shear strength of 45 psi (initial) to 230 psi (ultimate) and peel strength of 25 piw. Can be used in construction, display assembly, furniture assembly/repair and general assembly tasks including the bonding of kick plates to office desks and plastic lettering to wood.



Part Number	Container Size	Containers/Case
021200- 41554	47.7 lbs.	1
021200- 41599	26.2 lbs.	1

*Not for sale in California.

3M™ FoamFast 74 Spray Adhesive*

3M™ FoamFast 74 Spray Adhesive bonds foam to itself or other materials including most fabrics, wood or metal. Fast tack and non-dimpling. Various spray widths, from 1" to 12" can be achieved.

Part Number	Container Size	Containers/Case
021200- 49158	28.8 lbs.	1

*Not for sale in California.

3M™ Scotchgrip™ 1300L Rubber and Gasket Adhesive

A yellow, premium quality, versatile, heat resistant adhesive that develops strength rapidly. Has excellent adhesion to metal, wood, most plastics, and neoprene, reclaim, SBR, and butyl rubber.

Part Number	Container Size	Containers/Case
021200- 19936	5 Gallon Pail	1

3M™ Command™ Adhesives

3M™ Command™ Adhesive Products

3M™ Command™ Strips enable boat consumers to mount objects firmly on many surfaces and remove them without damaging the surface or leaving behind any sticky adhesive residue. 3M Command strips are available with hooks and clips or as replacement strips for a wide variety of applications. Hooks hold clothing, towels, etc. Clips for marine cables, wires and electronics. Hooks with Command water-resistant strips are available for use in wet environments. 3M Command strips hold on strongly, come off cleanly and leave no surface damage.

Part Number	Catalog Number	Description/ Size	Each/ Pack	Packs/ Case
051131- 65141	17001	Medium Utility Hooks 3.875" x 7.75" x 1.25"	6	36
051131- 65142	17003	Large Utility Hooks 3.875" x 7.75" x 1.25"	6	36
051131- 65601	17017	Wire Clips 3.875" x 7.75" x .438"	6	36
051131- 65988	17024	Poster Strips 3.875" x 7.75" x .188"	6	36
051131- 66206	17003CS	Clip Strip Large Utility Hooks	12	12
051131- 66207	17001CS	Clip Strip Medium Utility Hooks	12	12
051131- 66209	17024CS	Clip Strip Poster Strips	12	12
051131- 70532	17002	Small Hooks 7.75" x .3.876" x .75"	6	36
051131- 70533	17006	Mini Hooks 7.75" x .3.876" x 1"	6	36
051131- 70534	17004	Jumbo Hooks 7.75" x .3.876" x 1.875"	6	36
051131- 70535	17005	Spring Clip 7.75" x .3.876" x 1"	6	36
051131- 70536	17040	Sawtooth Picture Hanger 7.75" x .3.876" x .5"	6	36
051131- 85158	17081B	Medium Hooks 5.75" x 3.875" x .3	6	36
051131- 85159	17083B	Jumbo Hook 5.75" x 3.875" x 1.573	4	24
051131- 79268	17200	Removable Mounting Strips 6.75" x 3.875" x .125	6	36
051131- 80974	17201	Picture Hanging Strips 6.75" x 3.875" x .32	9	27
051131- 52184	17-SK	Display	1	35



17001



17003



17017



17024



17003CS



17001CS



17024CS



17002



17006



17004



17005



17040



17081B



17083B



17200



17201



17-SK

Fastening Systems

3M™ Marine Reclosable Attachment System

Five times stronger than conventional hook-and-loop fasteners. Industrial strength adhesive holds backing securely in place. Use for attaching marine electronics. Secure boat cushions, floor mats or mount pictures on cabin walls. Keeps loose items secure until they are needed.



Part Number	Size	Each/Case
051135-06539	Four 3" Strips	12 Blister Cards

3M™ Scotchmate™ Hook-and-Loop Fastening System

The 3M™ Scotchmate™ Hook-and-Loop Fastening System is comprised of two, 1" x 12" woven nylon strips, one strip of hook material and one of loop material, that mate together to hold items securely in place. Each strip is backed with a premium quality pressure-sensitive adhesive that is designed to meet the high and low temperature demands encountered in marine applications. Each 3M Scotchmate hook-and-loop package contains 12 mated strips and can be used for counter or pegboard display.



Part Number	Size	Each/Box	Boxes/Case
051131-06480	1" x 12" Mated Strips	12	6

3M™ Dual Lock™ Reclosable Fasteners

Two types of continuous plastic strips (Type 400 and Type 170) with mushroom shaped stems. They are designed to engage together one with another to provide reclosable fastening for a wide range of applications. 3M™ Dual Lock™ 400 has a dense stem pattern of approximately 400 stems/sq. in. Mating this product with 3M Dual Lock type 170 provides the most universal fastener combination in the 3M Dual Lock system. It locks together in any position and is generally the best choice for joining two surfaces when using the pressure-sensitive 3M Dual Lock products. 3M Dual Lock 170 has approximately 170 stems/sq. in. Besides general use with 3M Dual Lock type 400 it can also be mated with 3M™ Scotchmate™ loop products to provide an exceptional high-strength fastener with a limited reclosure life.



3M™ Dual Lock™ Plain Backed Reclosable Fasteners

(SJ-3441 Type 400 and SJ-3442 Type 170)

Plain Backed (no adhesive) 3M™ Dual Lock™ products are intended for attachment to various surfaces by sewing or by ultrasonic bonding to themselves, each other, or other polypropylene surfaces.

3M™ Dual Lock™ Pressure-Sensitive Backed General Purpose Reclosable Fasteners

(SJ-3541 Type 400 and SJ-3542 Type 170)

Designed for general purpose kinds of dynamic and static load applications where temperatures do not exceed 120°F. When applied under normal conditions, high adhesive bonds can be achieved to a wide variety of clean, dry surfaces including difficult surfaces like polyethylene and polypropylene.

3M™ Dual Lock™ Premium Performance Reclosable Fasteners

(SJ-3551 Type 400 and SJ-3552 Type 170)

High adhesive bonds can be achieved to a variety of surfaces, including paint, metal, and most plastics (except polyethylene or polypropylene). Special performance characteristics include:

- Good temperature and humidity cycling from -20°F to +200°F and 0% to 100% relative humidity.
- Good low and high temperature impact resistance at 20°F to 158°F.

Part Number	Product Number	Color	Packs/Case
1" x 50 yds.			
021200-86229	SJ3441	Black	2
021200-86230	SJ3442	Black	2
021200-86277	SJ3541	Black	2
021200-86309	SJ3542	Black	2
021200-86289	SJ3551	Black	2
021200-86279	SJ3552	Black	2

Fastening Systems

3M™ Dual Lock™ Reclosable Fastening System Mini Packs

3M™ Dual Lock™ Reclosable Fastening System offers advanced closure alternatives to zippers, screws, snaps, hooks, bolts and more. They're often better than conventional closure methods because they offer greater design flexibility, faster product assembly, smoother and cleaner exterior surfaces and improved product performance.



The new Mini Packs are great for design development and small-volume production requirements. Now you can inexpensively test and evaluate 3M's most popular reclosable fastening systems before making a more substantial investment. Mini Packs also simplify storage and dispensing.

Available in Mini Packs are both plain backed sew-on and adhesive-backed fasteners which allow for faster, easier attachment. Pressure-sensitive adhesive-backed versions include both general purpose and very-high-bond VHB adhesives.

Roll size is 1" x 4.9 yds./1 roll each of both sides included. There are 5 rolls per case.

Part Number	Product Number	Description	Temp.
Black			
051131- 06483	MP-3541/42	General Purpose Pressure-Sensitive Rubber Adhesive/ Bonds to Most Surfaces	120°F Continuous 158°F Intermittent
051131- 06484	MP-3551/52	Premium Acrylic Pressure-Sensitive Very-High-Bond Scotch™ VHB™ Adhesive UV and Plasticizer Resistant	Up to 200°F
Clear			
051131- 06463	MP-3560	"Clear" 3M™ Dual Lock™ Very-High-Bond Scotch™ VHB™ Adhesive UV and Plasticizer Resistant	Up to 200°F

Lubricants

3M™ Penetrant

3M™ Penetrant is a deep penetrating lubricant which frees rusted bolts, nuts, screws, and other mechanical fasteners. Also, it lubricates and protects against corrosion. Special spray tip actuator produces a straight shot spray pattern, minimizing overspray.



Part Number	Container Size	Cans/Case
051135-08876	12 oz. Aerosol	12

3M™ 4-Way™ Spray Lubricant

A specialized formula for general or all-around use. It provides characteristics of a lubricating oil, a penetrating oil and a demulsifying coating. A thin-bodied, transparent rust-preventative coating. Contains no silicone.



Part Number	Container Size	Cans/Case
051135-08898	10.5 oz. Aerosol	12

3M™ Lithium Lubricant

A heavy bodied lubricant with snorkel spray for hard-to-get-at areas. Excellent on all metal-to-metal parts.



Part Number	Container Size	Cans/Case
051135-08875	10.5 oz. Aerosol	12

3M™ Silicone Lubricant

Use 3M™ Silicone Lubricant to lubricate moving parts; eliminate squeaks caused by friction; prevent sticking and freezing; protect against rust and corrosion; seal out moisture; preserve plastic, rubber, leather; help prevent build up of glues, waxes, inks, paints, etc. Each can comes with a handy snorkel tube for small, hard-to-reach areas. It slips easily into the spray nozzle. Contains no methylene chloride, 1,1,1-trichloroethane or chlorofluorocarbons.



Part Number	Container Size	Cans/Case
021200-85822	24 fl. oz. Aerosol	12

3M™ Silicone Lubricant Plus (Wet Type)

A high solids silicone lubricant that provides a long "wet" appearance and increases sliding or lubricating qualities.



Part Number	Container Size	Cans/Case
051135-08877	9 oz. Aerosol	12

3M™ Spray Lube

3M™ Spray Lube is a clear fluid, high-performance, general purpose grease. It is designed to be water resistant. 3M™ Spray Lube can be used to lubricate many items including hinges, latches and seat tracts. 3M™ Spray Lube flows as a liquid then sets up to a uniform coating of grease.



Part Number	Container Size	Cans/Case
051135-08878	11 oz. Aerosol	12

3M™ Brake Lube/Anti-Seize

3M™ Brake Lube/Anti-Seize is a premium grade lubricant designed to prevent the seizure of close fitting metal parts. 3M™ Brake Lube/Anti-Seize Compound is resistant to high temperatures and designed to be used in critical applications such as lubricating brake parts, head bolts, spark plugs, oxygen sensors and most threaded fasteners.



Part Number	Container Size	Cans/Case
051135-08945	9 oz. Can	6

3M™ Silicone Paste

3M™ Silicone Paste is a 100% solid compound that is resistant to water and prevents oxidation on rubber or plastic parts such as weatherstrips, "O" rings, and rubber bushings. It can also be used to seal ignition systems. It has very good dielectric properties.



Part Number	Container Size	Cans/Case
051135-08946	8 oz. Can	6

3M™ Choke and Carb Cleaner

Penetrates quickly to loosen and clean away varnish, oil and gum. Has fast-cleaning action plus a powerful spray to flush away residue. Dries fast and may be used on cold, hot or running engines.



Part Number	Container Size	Cans/Case
051135-08796	12.5 oz. Aerosol	12

Paint and Varnish Remover and Accessories

3M™ Safest Stripper™ Paint and Varnish Remover

A revolutionary paint and varnish stripper that can be applied without gloves; just brush on a thick coat. It contains no methylene chloride fumes, non-caustic, no unpleasant odors, non-flammable and cleans up easily with water. Great for below deck applications where fumes can be a nuisance.



Part Number	Size	Containers/ Case
051111-10101	1 Quart	6
051111-10103	1 Gallon	2

3M™ Heavy Duty Stripping Pads (For Flat Surfaces)

The pads won't splinter, rust or shred like steel wool. They replace and outperform #2 and #3 steel wool. Ideal for marine applications.



Part Number	Size	Pads/ Package	Packages/ Case
051111-10111	3-1/2" x 5" x 1/2"	2	12

3M™ Heavy Duty Stripping Pads (Flexible for Curved Surfaces)

These pads provide aggressive stripping action, great on curved or rounded marine surfaces. They replace and outperform #2 steel wool.



Part Number	Size	Pads/ Package	Packages/ Case
051111-10112	6" x 3-7/8"	2	12

3M™ Final Stripping Pads (For Residue Removal)

Use these pads to thoroughly clean marine surfaces of any remaining stripper residue. This pad replaces "0" steel wool.



Part Number	Size	Pads/ Package	Packages/ Case
051111-10113	6" x 3-7/8"	2	12

3M Respirator Selection Guide



3M™ Full Facepiece Respirators 6000 Series



3M™ Speedglas™ Products



3M™ Half Facepiece Respirators 6000 Series



3M™ Full Facepiece Respirators 6000 Series



3M™ Particulate Filter 7093



3M™ Particulate Filter 2091



3M™ Half Facepiece Respirators 6000 Series



3M™ Belt-Mounted Powered Air Purifying Respirator (PAPR) Paint Spray Kit GVP-PSK Kit. Use 3M™ High Efficiency Cartridge GVP-440



3M™ Particulate Respirator 8210, N95



3M™ Particulate Respirator 8511, N95

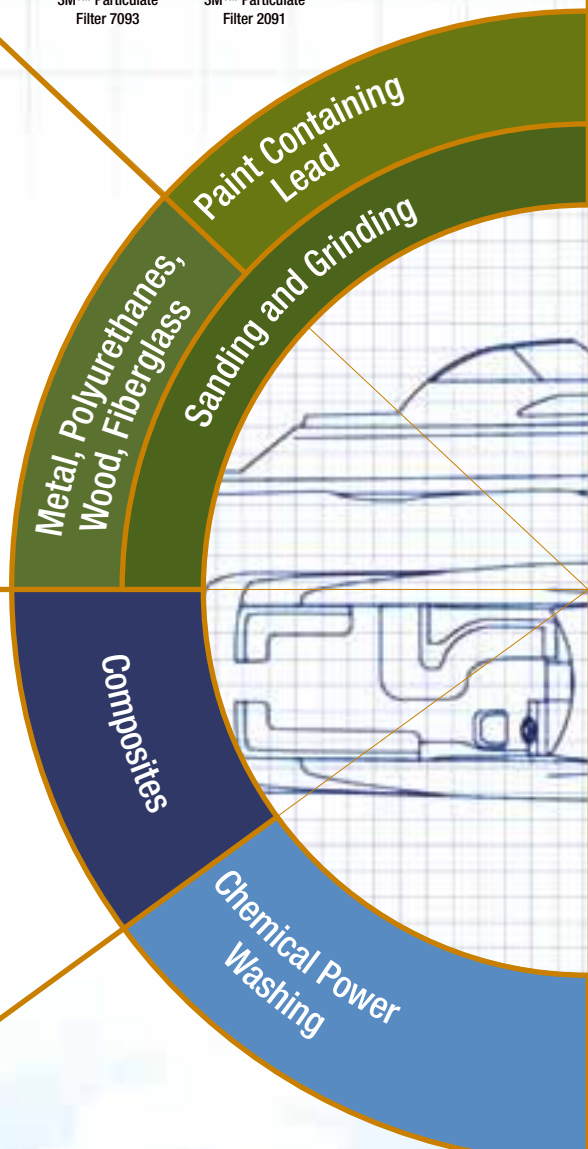

DISPOSABLE



3M™ Organic Vapor Respirator Assembly 51P71, 52P71, 53P71

REUSABLE



3M™ Professional Respirator Assembly Series R7511ES, R7512ES, R7513ES with 3M™ Organic Vapor Cartridge 6001



3M™ Particulate Respirator 8247, R95, with Nuisance Level Organic Vapor Relief*



3M™ Belt-Mounted Powered Air Purifying Respirator (PAPR) Paint Spray Kit GVP-PSK Kit. Use 3M™ High Efficiency Cartridge GVP-441



3M™ Full Facepiece Respirator Assembly OV/P95 67P71, 68P71, 69P71



3M™ Professional Series Half Facepiece 7500 Series with 3M™ Face Shield Kit 1631

* Nuisance level refers to concentrations not exceeding OSHA PEL/OEL or applicable exposure limits, whichever is lower.

Note: This wheel lists respirators available for various processes. Actual selection must be done by identifying the hazards and determining their concentration in the work environment.



3M™ Speedglas™ Products



3M™ Professional Series Respirator Assembly
R7511ES, R7512ES, R7513ES



3M™ Full Facepiece Respirators
6000 Series



3M™ Supplied Air Respirator Systems
H-Series Hoods



3M™ Belt-Mounted Powered Air Purifying Respirator (PAPR) Paint Spray Kit GVP-PSK Kit. Use 3M™ Organic Vapor/High Efficiency Cartridge GVP-441

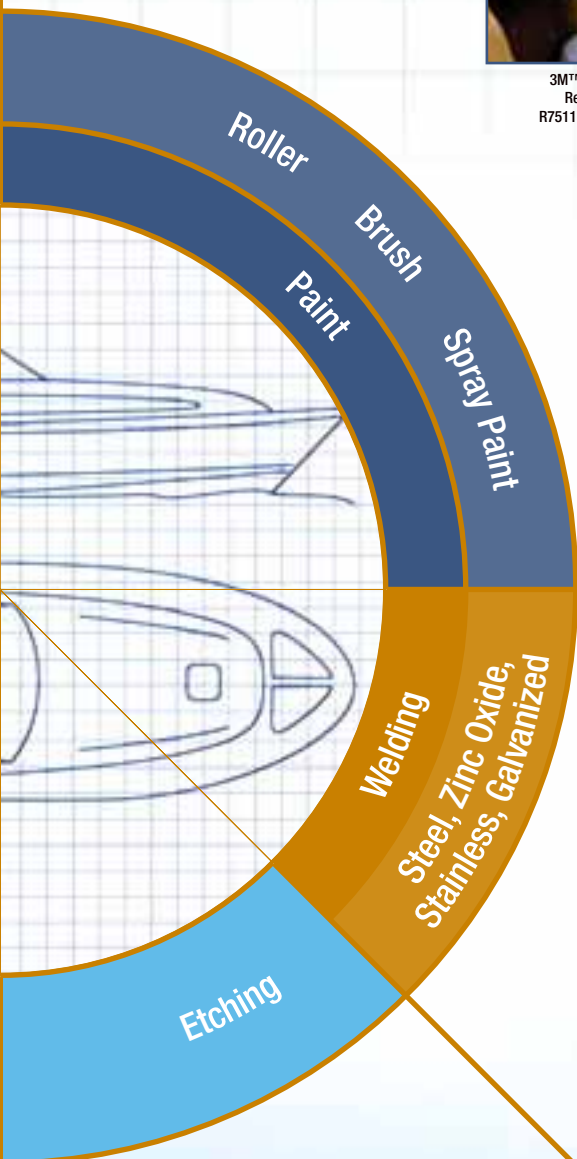

REUSABLE



3M™ Professional Series Half Facepiece
7500 Series



3M™ Speedglas™ Products



3M™ Full Facepiece Respirators 6000 Series



3M™ Organic Vapor/Acid Gas Cartridge 6003



3M™ Multi Gas Cartridge 6006



3M™ Particulate Welding Respirator
8515, N95



3M™ Particulate Welding Respirator
8515, N95

Grinding and Sanding Applications

Workers who perform grinding, sanding and related operations should always use proper respiratory protection. In addition, they should use protection against head, face and eye injury as well as protection against hearing loss. 3M offers products that can help protect and keep workers comfortable and safe in these applications.

3M™ Particulate Respirator 8210, N95

- Lightweight construction
- Foam nose seal
- Adjustable noseclip
- Helps provide excellent worker protection

Part Number	Respirators Per Box	Boxes Per Case
8210	20	8

3M™ Particulate Respirator 8511, N95

- 3M™ Cool Flow™ Exhalation Valve for added comfort and easier exhalation in hot and humid work settings
- Lightweight construction
- Helps provide excellent worker protection
- Stapled straps
- M-noseclip

Part Number	Respirators Per Box	Boxes Per Case
8511	10	8

3M™ Half Facepiece Respirator Packout 6191, 6291, 6391, P100

- Lightweight, comfortable
- Replaceable filters
- Available in 3 sizes
- Appropriate for use against asbestos
- Includes 1 pair of filters 2091, P100



The facepiece included with this packout can also be used with the filters shown below for grinding and sanding.

Part Number	Packout Description	Respirators Per Bag	Bags Per Case
6191	Small	1	24
6291	Medium	1	24
6391	Large	1	24



Particulate Filter 2071, P95



Particulate Filter 2091, P100



Particulate Filter 2097, P100*, **



Particulate Filter 7093, P100

Part Number	Filters Per Bag	Bags Per Case
2071	2	50
2091	2	50
2097	2	50
7093	4	15
7093B (Bulk)	4	36

* Provides nuisance level organic vapor relief. Nuisance level refers to concentrations not exceeding OSHA PEL or applicable government exposure levels, whichever is lower.
 ** 3M recommended for ozone protection up to 10 times the OSHA PEL. This product is not NIOSH approved for ozone protection.

3M™ Particulate Respirators 9210, 9211, N95

- Collapse resistant design
- Closed cell foam nose seal
- Easy to carry and to store
- Conforms to a wide range of face sizes
- Lightweight and comfortable
- 9211 (shown) has 3M™ Cool Flow™ Exhalation Valve for added comfort and easier exhalation in hot and humid work settings

Part Number	Respirators Per Box	Boxes Per Case
9210	20	12
9211	10	12

3M offers a broad range of respiratory protection products. For more information, visit www.3M.com/occsafety

See page 124 for Important WARNINGS

Belt-Mounted PAPR Systems for Grinding and Sanding

GVP Series



Part Number	Description	Respirators Per Box	Boxes Per Case
6700DIN	Small Facepiece	1	4
6800DIN	Medium Facepiece	1	4
6900DIN	Large Facepiece	1	4

Part Number	UPC Number	Description	Packs Per Case
H-411	051138-66096	Hood Assembly with Collar and Cap Suspension Tychem® QC	1
L-501	051131-37008	Bumpcap with Wide View Faceshield	1
L-901	051138-66155	Helmet with Wide View Faceshield	1



Part Number	UPC Number	Description	Packs Per Case
GVP-122	051138-29214	Breathing Tube (for GVP-1 with H-Series Hoods)	1
GVP-123	051138-29215	Breathing Tube (for GVP-1 with 7800S Full Facepiece)	1
L-122	051131-37012	Breathing Tube (for use with L-Series Headgear)	1



3M™ GVP-Series PAPR Systems

- Can be used with several different 3M facepieces, headgear and hoods
- Provides high levels of air flow
- Allows you to select several different cartridges for different contaminants
- Lightweight components are comfortable to wear
- Includes an eight hour battery
- Intrinsically safe

3M™ Adflo™ PAPR System with 3M™ Speedglas™ ClearVisor



Adflo™ PAPR System
16-1101-40



- Provides constant airflow even as filter loads
- Uses a brushless motor that has three times the life of standard PAPR motors
- Eye*, face and respiratory protection in a single unit
- Uses an environmentally-friendly NiMH battery that fully charges in less than three hours

Part Number	Description	Packs Per Case
16-1101-40	3M™ Adflo PAPR System with 3M™ Speedglas™ ClearVisor	1

* Safety glasses must be used under all secondary eye protection devices.

For information on Positive Pressure Respirator Systems, see pages 116, 117, 118 and 119.

Welding Applications

Welding and other metal working jobs can create a variety of fumes and gases that present unique respiratory protection challenges. In addition, these applications require hearing and specialized head and eye protection. 3M provides a comprehensive line of respirators and other products that can enhance safety in most welding/metal working jobs.

3M™ Particulate Welding Respirator 8515, N95

- 3M™ Cool Flow™ Exhalation Valve for added comfort and easier exhalation in hot and humid work settings
- Comfortable, reliable and economical protection
- 3M™ Welding Web is flame resistant as demonstrated per ASTM D 2859-96
- Adjustable M-noseclip for greater comfort
- Lightweight

Part Number	Respirators Per Box	Boxes Per Case
8515	10	8

3M™ Particulate Welding Respirators 8214, 8514, N95

- 3M recommended for protection against ozone up to 10 times the OSHA PEL*
- Nuisance level organic vapor relief**
- Carbon filter media
- Wide, adjustable straps
- 3M™ Welding Web is flame resistant as demonstrated per ASTM D 2859-96
- 3M cake-resistant filter media for longer filter life
- 3M™ Cool Flow™ Exhalation Valve for added comfort and easier exhalation in hot and humid work settings
- 8214 has special face seal

Part Number	Respirators Per Box	Boxes Per Case
8214	10	8
8514	10	8

3M™ Particulate Welding Respirators 8212, 8512, N95

- 3M cake-resistant filter media for longer filter life
- Wide, adjustable straps
- 3M™ Welding Web is flame resistant as demonstrated per ASTM D 2859-96
- 3M™ Cool Flow™ Exhalation Valve for added comfort and easier exhalation in hot and humid work settings
- 8212 has special face seal

Part Number	Respirators Per Box	Boxes Per Case
8212	10	8
8512	10	8

3M™ Professional Series Half Facepiece Respirator 7501, 7502, 7503, P100

- 3M™ Cool Flow™ Exhalation Valve for added comfort and easier exhalation in hot and humid work settings
- Reduced heat and moisture build up
- Thin-wall design around the nose for greater comfort



Use this facepiece with the filters shown below.



Particulate Filter
2091, P100



Particulate Filter
2097, P100*, **



Particulate Filter
7093, P100

Part Number	Facepiece Description	Facepieces Per Bag	Bags Per Case
7501	Small	1	10
7502	Medium	1	10
7503	Large	1	10

Part Number	Filters Per Bag	Bags Per Case
2091	2	50
2097	2	50
7093	4	15
7093B (Bulk)	4	36

* 3M recommended for ozone protection up to 10 times the OSHA PEL.
This product is not NIOSH approved for ozone protection.
** Nuisance level refers to concentrations below the current OSHA PELs.

See page 124 for Important WARNINGS

Belt-Mounted PAPR Systems for Welding

GVP Series



Part Number	UPC Number	Description	Packs Per Case
L-503	051138-66148	Bumpcap with Welding Shield	1
L-905	051138-66156	Helmet with Welding Shield and Wide View Faceshield	1

Part Number	Description	Respirators Per Box	Boxes Per Case
7800S-S	Small Facepiece	1	1
7800S-M	Medium Facepiece	1	1
7800S-L	Large Facepiece	1	1



Breathing Tube
L-122



Breathing Tube
GVP-123

Part Number	UPC Number	Description	Packs Per Case
L-122	051131-37012	Breathing Tube (for use with L-Series headgear)	1
GVP-123	051138-29215	Breathing Tube (for GVP-1 with 7800S Full Facepiece)	1



3M™ GVP-Series PAPR Systems

- Can be used with several different 3M facepieces, headgear and hoods
- Provides high levels of air flow
- Allows you to select several different cartridges to fit the contaminant
- Lightweight components are comfortable to wear
- Includes an eight hour battery
- Intrinsically safe

3M™ Adflo™ PAPR System with 3M™ Speedglas™ Filter and Helmet



Adflo™
PAPR System



- Provides constant airflow even as filter loads
- Uses a brushless motor that has three times the life of standard PAPR motors
- Eye*, face and respiratory protection in a single unit
- Uses an environmentally-friendly NiMH battery that fully charges in less than three hours
- 3M™ Speedglas™ SideWindows optional for better peripheral vision

Contact your 3M Distributor for additional information on Speedglas Helmet and Adflo PAPR combinations. Systems are available with all 9000 and 9002 lenses and include FlexView and SideWindows options.

* Safety glasses must be used under all secondary eye protection devices.

For information on Positive Pressure Respirator Systems, see pages 116, 117, 118 and 119.

3M™ Speedglas™ Products

With the addition of the highly regarded Speedglas product line, 3M now offers an even more extensive line of safety products for grinding, sanding and welding applications. These products provide a high level of comfort and protection for people working in welding and other metal working jobs. An unmatched product line coupled with experience and integrity...that's 3M.

3M™ Speedglas™ Filter 9000F/9000XF

- Shade 5 off state and safety state
- Available in three factory-set dark shades: 10, 11 or 12
- Fixed dark shade filter provides exceptional optical clarity
- Shade 3 light state
- For rugged, long-term use
- 9000XF has an extra large filter viewing area...44% larger than most auto-darkening filters

3M™ Speedglas™ Utility Filter Shades 10, 11

- Designed for part-time welding/metal working
- Our most affordable auto-darkening filter and helmet
- For MIG and stick welding
- Two filter models: dark shade 10 or 11
- UV/IR protection is constant even when filter is OFF or in shade 3 light state



3M™ Speedglas™ Filter 9002V/9002X

- Fully adjustable delay function allows welder to add or decrease time before the filter switches from dark to light
- Sensitivity adjustment helps control interferences and multiple arc triggering issues
- User can select shades from 9 through 13
- The membrane-covered control buttons allow the user to easily change settings with gloves on
- Membrane covered controls seal the filter from dirt for longer life
- User can choose many different control combinations for personal comfort
- 9002X has an extra large filter for a better view of the work area



See page 124 for Important WARNINGS

3M™ Speedglas™ Products

3M™ Adflo™ PAPR System with 3M™ Speedglas™ Filter and Helmet

- Provides eye, face and respiratory protection in a single unit
- The OV/SD/CL/HC cartridge can be stacked onto a HEPA particle filter for added protection. You don't have to change both filters at the same time
- The Adflo system has a slim profile to fit into tight places
- No external batteries, no battery cables
- Uses a brushless motor that provides three times the life of standard PAPR motors
- Constant airflow even as filter loads
- Audible and visual alarms signal low battery charge and low airflow rate



Unique Features (See Selection Chart for Availability)

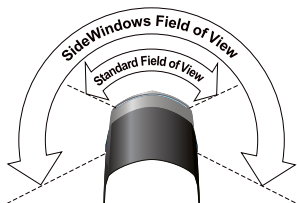

3M™ Speedglas™ Helmet with SideWindow Filters

Now welders can get much better peripheral vision with our helmets with special side filters. These impact resistant polycarbonate, shade 5 filters increase viewing area by over 100%.



Special Ventilation

The Speedglas helmet features aerodynamically designed vents to help remove exhaled air and to prevent entry of welding smoke. This is a comfort and safety feature that welders really appreciate.



3M™ Speedglas™ FlexView System

Developed specifically for welding and welding preparation, the user simply lifts the spring-mounted filter assembly for a better view for chipping, grinding and prep work. The spring holds the filter in place on top of the helmet, giving a clear view through the clear FlexView faceshield.



3M™ Speedglas™ ProTop System

Provides comfortable, well-balanced hard hat protection. In the up position, the helmet "nests" down low over the hard hat for a low center of gravity. A pivot mechanism holds the helmet in both positions.



Selection Chart

Product	Standard Helmet	SideWindows	ProTop	ProTop with SideWindows	FlexView	FlexView with SideWindows	FlexView with ProTop	FlexView with ProTop and SideWindows
Utility								
9000F								
9000XF								
9002V								
9002X								



Paint Spray Applications

Painters must be properly protected at all times. Even short periods of unprotected exposures to paint mists and vapors can cause serious health problems. 3M offers comfortable and effective safety products for these applications. To help ensure that painters are protected at all times of exposure, it is critical that a cartridge changeout schedule be established and followed.

3M™ Disposable Half Facepiece Respirator 51P71, 52P71, 53P71

- Disposable design
- Helps protect against organic vapors
- Filters solid and liquid particles including those containing oil
- Permanently attached cartridges and replaceable filters

Part Number	OV/P95 Respirator Assembly Description	Respirators Per Case
51P71	Small	12
52P71	Medium	12
53P71	Large	12

3M™ Professional Series Half Facepiece Respirator Packout R7511ES, R7512ES, R7513ES

- 3M™ Cool Flow™ Exhalation Valve for added comfort and easier exhalation in hot and humid work settings
- Reduced heat and moisture build up lead to longer wearing time
- The unique head harness design adds stability and comfort
- Thin-wall design around the nose adds comfort
- Fully maintainable

Part Number	Packout Description	Packouts Per Case
R7511ES	Small	4
R7512ES	Medium	4
R7513ES	Large	4

3M™ Reusable Full Facepiece Respirator Packout 67P71, 68P71, 69P71

- Reusable respirator assembly
- Offers limited eye protection
- Helps protect against organic vapors
- Fully maintainable

Part Number	Packout Description	Packouts Per Case
67P71	Small	2
68P71	Medium	2
69P71	Large	2

3M™ Organic Vapor Monitor 3500/3510

- Determine exposure levels to vapors
- Place on painter, in spray booth or in mixing room for the full work day
- Can be used to help establish a cartridge changeout schedule

Part Number	Description	Monitors Per Case
3500	OV Monitor	10
3510	OV Monitor, Includes Prepaid Analysis	5



A Complete Family of Dual Cartridge Respirators for Grinding, Sanding, Welding and Paint Spray Applications

Facepieces



Half Facepiece
7501 (Small)
7502 (Medium)
7503 (Large)



Full Facepiece
6700 (Small)
6800 (Medium)
6900 (Large)



Full Facepiece
7800S (Small)
7800S (Medium)
7800S (Large)

Part Number	Facepiece Description	Facepieces Per Box	Boxes Per Case
7501	Small	1	10
7502	Medium	1	10
7503	Large	1	10
6700	Small Facepiece	1	4
6800	Medium Facepiece	1	4
6900	Large Facepiece	1	4
7800S-S	Small Facepiece	1	4
7800S-M	Medium Facepiece	1	4
7800S-L	Large Facepiece	1	4

For Grinding, Sanding, Welding



Particulate Filter
2071, P95



Particulate Filter
2091, P100



Particulate Filter
2097, P100



Particulate Filter
7093, P100

Part Number	Filters Per Bag	Bags Per Case
2071	2	50
2091	2	50
2097	3	50
7093	4	15
7093B	4	36

For Paint Spray



Replacement Retainer
501



Replacement Filter
5P71, P95



Replacement
OV Cartridge 6001



Replacement Cartridge/Filter
Packout R6022

Part Number	Description	Filters/Cartridges Per Box	Boxes Per Case
501	Filter Retainer	20	5
5P71	Replacement Filter	10	10
6001	Organic Vapor Cartridge	2	30
R6022	Replacement Cartridge/Filter Packout	1	5



Packouts: Includes facepieces with cartridges/filters. This is a good way to start a 3M respirator program.



Professional Series
Respirator OV/P95



Full Facepiece
Respirator OV/P95



Half Facepiece
Respirator P100

Part Number	Packout Description	Packouts Per Case
R7511ES	Small	4
R7512ES	Medium	4
R7513ES	Large	4

Part Number	Packout Description	Packouts Per Case
67P71	Small	2
68P71	Medium	2
69P71	Large	2

Part Number	Packout Description	Packouts Per Case
6191	Small	24
6291	Medium	24
6391	Large	24

GVP Powered Air Purifying Respirators (PAPRs) for Paint Spray Applications

3M™ Belt-Mounted Powered Air Purifying Respirators

The 3M™ Belt-Mounted PAPR combines a high level of protection with great performance and versatility. This innovative design is able to operate with the 3M™ H-Series Hoods, L-Series Headgear and the Full Facepieces 7800S and 6000 Series.



The GVP-1 PAPR Assembly Includes:

- Motor Blower GVP-100
- Power Cord GVP-110
- Battery Pack GVP-111
- Battery Charger GVP-112
- Flow Meter GVP-113
- Blower Plugs GVP-115
- Filter Plugs GVP-116
- Web Belt GVP-127
- Web Shoulder Strap GVP-128

Part Number	PAPR Per Box	Box Per Case
GVP-1	1	1

Part Number	Description	Packs Per Case
L-501	Bumpcap with Wide View Faceshield	1
7800S-S	Small Facepiece	4
7800S-M	Medium Facepiece	4
7800S-L	Large Facepiece	4
6700	Small Facepiece	4
6800	Medium Facepiece	4
6900	Large Facepiece	4
H-411	Hood Assembly with Collar and Cap Suspension, Tychem® QC	1
H-412	Hood Assembly with Collar and Hardhat, Tychem® QC	1

Part Number	Description	Packs Per Case
L-122	Breathing Tube (for use with L-Series headgear)	1
GVP-123	Breathing Tube (for GVP-1 with 6000 Series/7800S Full Facepieces)	2
GVP-122	Breathing Tube (for GVP-1 with H-Series Hoods)	1



3M™ Belt-Mounted PAPR with Comfort Belt GVP-PSK/07190

This system includes all of the components that make up our PAPR with Bumpcap and is now available as a single part number in a single package.



Includes:

- All components from GVP-CB assembly
- Bumpcap with Wide View Faceshield L-501
- Breathing Tube L-122
- Comfort Belt-Mounted PAPR Assembly
- Organic Vapor/HEPA Cartridge GVP-441
- Shower Cover GVP-119
- (5) Peel-off Lens Covers L-133

Part Number	Description	Packs Per Case
GVP-PSK/07190	PAPR Paint Spray Kit	1



Comfort Belt-Mounted PAPR Assembly GVP-CB

Each Assembly Includes:

- Motor Blower GVP-112
- Flow Meter GVP-113
- Power Cord GVP-110
- Blower Plugs GVP-115
- Flow Meter Adapter L-181
- Adjustable Comfort Belt CB-1000



Part Number	Description	Packs Per Case
GVP-CB	Comfort Belt-Mounted PAPR Assembly (one size fits most)	1

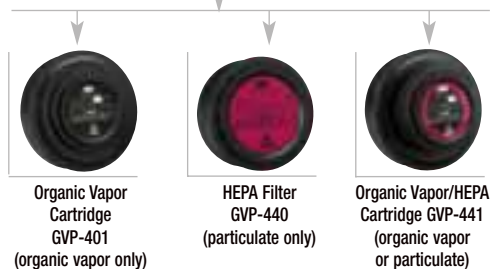

Part Number	Description	Packs Per Case
GVP-401	Organic Vapor Cartridge	6
GVP-440	HEPA Filter	8
GVP-441	Organic Vapor/HEPA Cartridge	6

Supplied Air Respirator Systems Using H-Series Hoods



Hood Assembly
(with Collar and Cap)
H-411

Hood Assembly
(with Inner Shroud and Hardhat)
H-422

Part Number	Description	Packs Per Case
H-411	Hood Assembly with Collar and Cap Suspension Tychem® QC	1
H-422	Hood Assembly with Inner Shroud and Hardhat Tychem® QC	1



Breathing Tube
W-5114

Part Number	Description	Packs Per Case
W-5114	High Pressure Breathing Tube (60-100 psi Supply Pressure)	1



Vortex Cooling Assembly
W-2862

Air Regulating Valve Assembly
W-2907

Low Pressure Adapter Assembly
W-3018

Part Number	Description	Packs Per Case
W-2862	Vortex Air Cooling Assembly	1
W-2907	Air Regulating Valve Assembly	1
W-3018	Low Pressure Adapter Assembly	1



High Pressure Hose, 3/8"
W-9435-25 ft.
W-9435-50 ft.
W-9435-100 ft.



Low Pressure Hose, 1/2"
W-3020-25 ft.
W-3020-50 ft.
W-3020-100 ft.

Part Number	Air Hose Description	Packs Per Case
W-9435-25	High Pressure 25', 3/8" ID	1
W-9435-50	High Pressure 50', 3/8" ID	1
W-9435-100	High Pressure 100', 3/8" ID	1
W-3020-25	Low Pressure 25', 1/2" ID	1
W-3020-50	Low Pressure 50', 1/2" ID	1
W-3020-100	Low Pressure 100', 1/2" ID	1



Portable Air Purification Panel
(50 cfm) with CO Filtration
and Monitor, 4 Outlets
256-02-00

Portable Air Purification Panel
(100 cfm) with CO Monitor, 8 Outlets
256-02-01

Portable Air Purification Panel
(50 cfm) without CO Monitor
W-2806

Retrofit CO Monitor Kit
W-2808

Part Number	Description	Packs Per Case
256-02-00	Portable Air Purification Panel (50 cfm) with CO Filtration and Monitor, 4 Outlets	1
256-02-01	Portable Air Purification Panel (100 cfm) with CO Monitor, 8 Outlets	1
W-2806	Portable Air Purification Panel (50 cfm) without CO Monitor	1
W-2808	Retrofit CO Monitor Kit	1

Supplied Air Respirator Systems Using L-Series Headgear



Part Number	Description	Packs Per Case
L-501	Bumpcap with Wide View Faceshield	1
L-122	Breathing Tube (for use with L-Series headgear)	1



Bumpcap with Wide View Faceshield L-501

Breathing Tube L-122



Vortex Cooling Assembly V-100

Air Regulating Valve Assembly V-300

Low Pressure Connector Assembly V-400

Part Number	Description	Packs Per Case
V-100	Vortex Cooling Assembly	1
V-300	Air Regulating Valve Assembly	1
V-400	Low Pressure Connector Assembly	1

Part Number	Air Hose Description	Packs Per Case
W-9435-25	High Pressure 25', 3/8" ID	1
W-9435-50	High Pressure 50', 3/8" ID	1
W-9435-100	High Pressure 100', 3/8" ID	1
W-3020-25	Low Pressure 25', 1/2" ID	1
W-3020-50	Low Pressure 50', 1/2" ID	1
W-3020-100	Low Pressure 100', 1/2" ID	1



High Pressure Hose, 3/8"
W-9435-25 ft.
W-9435-50 ft.
W-9435-100 ft.



Low Pressure Hose, 1/2"
W-3020-25 ft.
W-3020-50 ft.
W-3020-100 ft.



Portable Air Purification Panel (50 cfm) with CO Filtration and Monitor, 4 Outlets 256-02-00

Portable Air Purification Panel (100 cfm) with CO Monitor, 8 Outlets 256-02-01

Portable Air Purification Panel (50 cfm) without CO Monitor W-2806

Retrofit CO Monitor Kit W-2808

Part Number	Description	Packs Per Case
256-02-00	Portable Air Purification Panel (50 cfm) with CO Filtration and Monitor, 4 Outlets	1
256-02-01	Portable Air Purification Panel (100 cfm) with CO Monitor, 8 Outlets	1
W-2806	Portable Air Purification Panel (50 cfm) without CO Monitor	1
W-2808	Retrofit CO Monitor Kit	1

Dual Airline Supplied Air Respirator Systems Using 3M Facepieces



Part Number	Facepiece Description	Facepieces Per Box	Box Per Case
6700	Small Facepiece	1	4
6800	Medium Facepiece	1	4
6900	Large Facepiece	1	4
7800S-S	Small Facepiece	1	4
7800S-M	Medium Facepiece	1	4
7800S-L	Large Facepiece	1	4
7501	Small	1	10
7502	Medium	1	10
7503	Large	1	10

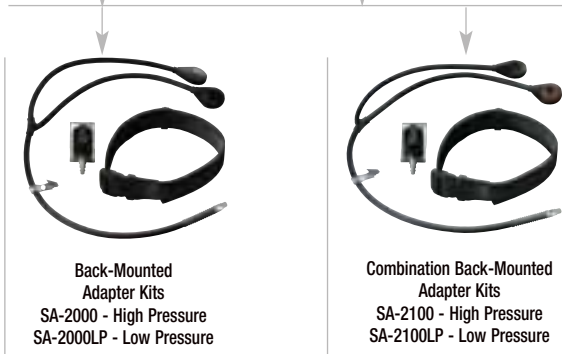

For Negative Pressure



SA-2000LP Adapter Kit (low pressure)
Includes SA-2500 Back-Mounted Breathing Tube, GVP-127 Web Belt and SA1009 Air Regulator **or** SA-1029 Connector (low Pressure).

Combination Dual Airline SA-2100 or SA-2100LP (low pressure) Adapter Kit
Includes SA-2600 Combination Back-Mounted Breathing Tube, GVP-127 Web Belt and SA-1009 Air Regulator **or** SA-1029 Connector (low pressure). Cartridges/filters not included.

Part Number	Adapter Kit Description	Kits Per Case
SA-2000	High Pressure	1
SA-2000LP	Low Pressure	1
SA-2100	High Pressure	1
SA-2100LP	Low Pressure	1



Part Number	Air Hose Description	Packs Per Case
W-9435-25	High Pressure 25', 3/8" ID	1
W-9435-50	High Pressure 50', 3/8" ID	1
W-9435-100	High Pressure 100', 3/8" ID	1
W-3020-25	Low Pressure 25', 1/2" ID	1
W-3020-50	Low Pressure 50', 1/2" ID	1
W-3020-100	Low Pressure 100', 1/2" ID	1

Part Number	Description	Filters/Cartridges Per Box	Boxes Per Case
501	Filter Retainer	20	5
5P71	Particulate Filter	10	10
6001	Organic Vapor Cartridge	2	30



Part Number	Description	Packs Per Case
256-02-00	Portable Air Purification Panel (50 cfm) with CO Filtration and Monitor, 4 Outlets	1
256-02-01	Portable Air Purification Panel (100 cfm) with CO Monitor, 8 Outlets	1
W-2806	Portable Air Purification Panel (50 cfm) without CO Monitor	1
W-2808	Retrofit CO Monitor Kit	1



Sorbent Products



3M sorbents are used extensively in a wide variety of applications. From routine maintenance to emergency spill cleanup, we offer a sorbent that is designed for the specific job. And these products are designed with total cost in mind. By considering all cost factors—sorbent capacity, labor, disposal and the product cost—3M sorbents are an economical and effective choice.



3M™ Petroleum Sorbents

- Used extensively for cleaning up and recovering petroleum-based liquids
- Effective for use under leaking equipment
- Dust free and contain no abrasive granules that could damage equipment
- Can be incinerated with only 0.2% ash residue
- Repels water while absorbing petroleum based liquids



3M™ Maintenance Sorbents

- Ideal for many facility maintenance jobs
- Designed to absorb non-aggressive liquids such as oils, coolants, cutting fluids, aqueous-based fluids and petroleum-based products
- Can be wrung out and reused numerous times with virtually no loss of sorbent capacity
- Easy to handle; they can be put in place in just minutes
- Dust free and contain no abrasive granules that could damage equipment
- Lightweight and very versatile

Part Number	Approx. Dimensions/ Sorbent Capacity	Each Per Case
M-FL550DD	5" X 50'/Box (9 Gallons/Box)	3
M-RL15150DD	15 1/2" X 150' Roll (20 Gallons/Case)	1
M-RL38150DD	38" X 150' Roll (50 Gallons/Case)	1
M-DC22DD	22" Drum Cover w/skirt (13 Gallons/Case)	25
M-RG36300E	36" X 300' Rug (32 Gallons/Roll)	1
M-RGC36100E	36" X 100' Rug w/coating (10.5 Gallons/Roll)	1

3M also offers a complete line of sorbents for responding to chemical spills. See your 3M Distributor for details.

Part Number	Approx. Dimensions/ Sorbent Capacity	Packaging
29026	7" X 15" (35 Gallons/Bag)	16 Pillows/Case
T-210	25 lbs./Bag (35 Gallons/Bag)	1 Bag/Bale
T-240	5" X 14" X 25" (2 lbs./Pillow, 3.5 Gallons/Pillow)	10 Pillows/Bale
T-30	7" X 15" (.5 Gallons/Pillow)	16 Pillows/Bale
T-270	8" Diameter X 10' (10 lbs./Boom, 20 Gallons/Boom)	4 Booms/Bale
T-280	5" Diameter X 10' (6.5 lbs./ Double Boom, 10 Gallons/Boom)	4 Double Booms/Bale
P-FL550DD	5" Diameter X 50'/Box (8 Gallons/Box)	3 Boxes/Case
T-100	38" X 144' X 3/8" (51 Gallons/Rolls)	1 Roll/Bag
HP-100	38" X 144' X 1/4" (51 Gallons/Rolls)	1 Roll/Bag
T-126	17" X 100' X 3/8" (17 Gallons/Sweep)	1 Sweep/Bale
T-151	17" X 19" X 3/8" (.13 Gallons/Pad)	200 Pads/Bale
T-156	17" X 19" X 1/4" (.25 Gallons/Pad)	100 Pads/Bale
T-157	34" X 38" X 3/8" (1 Gallon/Pad)	50 Pads/Bale
HP-156	17" X 19" X 1/4" (1 Gallon/Pad)	100 Pads/Bale
HP-157	34" X 38" X 1/4" (1 Gallon/Pad)	50 Pads/Bale
HP-255	17" X 19" X 1/2" (.5 Gallons/Pad)	50 Pads/Bale
HP-256	17" X 119" X 1/2" (.5 Gallons/Pad)	100 Pads/Bale

3M™ Spill Kits and Response Packs

- The perfect solution for emergency response
- 5-gallon Spill Kits are compact and easy to store until needed
- 31-gallon Spill Kits are packed in a color-coded, 20-gallon drum



Part Number	Kit Contents	Kits Per Case
P-SKFL31	Petroleum Sorbent - Folded (P-FL550DD) - 2 Rolls 5" X 50' Folded (19" X 50' fully opened) Petroleum Sorbent Pads (HP-156) - 30 Each 17" X 19" Temporary Disposal Bags and Ties - 3 White Drum with lid and plastic closure ring 1 Each 20 Gallon	1
P-SKFL5	5" X 26' with Perforations every 16" (19" X 26' fully opened) One temporary disposal bag and tie	3

See page 124 for Important WARNINGS

Head and Face Protection Products

Head injuries are among the most common injuries that occur in all industries. For that reason, industry standards have been established to protect against such injuries. 3M offers a line of hard hats that can be used in virtually all industrial applications. These hard hats meet the requirements of ANSI Z89.1-1997, Type I, Class C, E and G. They are available with a slide or ratchet suspension for size adjustment.



3M™ Omega II™ Hard Hats, Standard Suspension

- Lightweight and well-balanced for worker comfort and acceptance
- Slide sizing adjustment with six-point suspension
- Fits sizes 6 ½ – 7 ¾

3M™ Omega II™ Hard Hats, Ratchet Suspension

- This design allows the user to adjust the size for perfect fit without removing the hard hat
- Soft, removable brow pad
- Polyethylene headband allows maximum adjustability for greatest comfort
- Fit sizes 5 7/8 – 8

3M™ Omega II™ Hard Hats are designed with the user in mind



Standard Suspension



Ratchet Suspension

3M™ Hard Hat Mounted Ear Muffs 1450

- Two-position design fits a variety of hard hats
- Ear muffs flip up and stay in position when not in use
- Noise reduction rating of 23dB
- Use with Replacement Parts Kit 1442

Part Number	UPC Number	Description	Each Per Case
1450	051138-29335	Hard Hat Mounted Ear Muffs	20
1901	051138-76809	Omega II™ Hard Hat White, Standard Suspension	30
1902	051138-76810	Omega II™ Hard Hat Yellow, Standard Suspension	30
1903	051138-76811	Omega II™ Hard Hat Orange, Standard Suspension	30
1905	051131-52590	Omega II™ Hard Hat Red, Standard Suspension	30
1906	051131-52591	Omega II™ Hard Hat Blue, Standard Suspension	30
1911	051138-76813	Omega II™ Hard Hat White, Ratchet Suspension	30
1912	051138-76814	Omega II™ Hard Hat Yellow, Ratchet Suspension	30
1915	051131-52592	Omega II™ Hard Hat Red, Ratchet Suspension	30
1916	051131-52593	Omega II™ Hard Hat Blue, Ratchet Suspension	30
1904	051138-76812	Replacement Standard Suspension	10
1914	051138-76816	Replacement Ratchet Suspension	30
1950	051138-76831	Replacement Brow Pad	10

3M™ Face Shield Kit 1631

- Uses replaceable polycarbonate material for clearer vision
- Cam lock helps hold the face shield in place
- Simple slide-sizing adjustment
- Use Replacement Visor Kit 1632



Part Number	UPC Number	Description	Each Per Case
1631	051138-37106	Faceshield Kit	5

See page 124 for Important WARNINGS

Protective Eyewear

Eye injuries can result from many different workplace hazards including splashes, debris and impact. 3M eye protection products can help enhance safety in areas where such hazards exist. These products are available in several styles with different lens/frame color combinations for greater personal choice. They are comfortable, fashionable and are a very good value.



3M™ Protective Eyewear 1701, 1702

- Polycarbonate lenses with 99% UV protection
- Lightweight and comfortable
- High worker acceptance

Part Number	UPC Number	Description	Each Per Case	Packs Per Case
1701	051138-76800	Protective Eyewear, Smoke Frame, Smoke Lens	1	24
1702	051138-76801	Protective Eyewear, Clear Frame, Clear Lens	1	24



3M™ Protective Eyewear 1722, 1723, 1740, 1743

- Polycarbonate lenses with 99% UV protection
- Wraparound design
- Non-slip rubber head grip for wearer comfort
- 5-position adjustable temple
- Soft vinyl nose pad

Product Number	UPC Number	Description	Each Per Case	Packs Per Case
1722	051138-76806	Protective Eyewear, Red, White and Blue Frame, Clear Lens	1	24
1723	051131-37109	Protective Eyewear, Black Frame, Amber Lens	1	24
1740	051131-37110	Protective Eyewear, Clear Lens	1	24
1743	051131-37112	Protective Eyewear, Amber Lens	1	24



3M™ Protective Eyewear 1750, 1751, 1752, 1760

- Stylish, contemporary design
- Lightweight, comfortable lens
- Wraparound design provides side protection
- Shatter-resistant polycarbonate lens
- Provides 99% UV protection

Part Number	UPC Number	Description	Each Per Case	Packs Per Case
1750	051131-37113	Protective Eyewear, Gray Frame, Clear Lens	1	24
1751	051131-37114	Protective Eyewear, Gray Frame, Smoke Lens	1	24
1752	051131-37115	Protective Eyewear, Blue Frame, Mirrored Lens	1	24
1760	051131-37116	Protective Eyewear, Clear Frame, Clear Lens	1	24

3M™ Visitor Specs 1611, Clear

- Polycarbonate lenses with 99% UV protection
- Intended for visitors and other short-term users
- Can be worn alone or over prescription glasses



Part Number	UPC Number	Description	Each Per Pack	Packs Per Case
1611	051131-37101	Visitor Specs, Clear	1	300

See page 124 for Important WARNINGS

Hearing Protection Products

In a typical workplace, noise is an ever-constant problem. To protect themselves, workers must have available and always use comfortable and effective products to help prevent long-term hearing loss due to exposure to pounding, grinding, high-pressure spray operations, air wrenches, overhead cranes, etc. 3M offers a variety of ear muffs and ear plugs to reduce noise levels that are present in most industrial settings.



3M™ Padded Ear Muffs 1440

- Comfortable padded headband
- Lightweight
- Noise Reduction Rating of 24dB*
- Contoured ear cushion seal
- Use with Replacement Parts Kit 1442

3M™ Three-Position Ear Muffs 1427

- Rotating head band and adjustable strap provides secure fit in any of the three positions
- Noise Reduction Rating of 27dB* when band is worn over or behind the head. Noise Reduction Rating is 26dB* when band is worn under the chin.



Part Number	UPC Number	Pairs Per Case
1440	051138-29334	20
1427	051138-76981	20



3M™ Banded Hearing Protector 1310

- The unique band stays in place without a lot of pressure
- Noise Reduction Rating of 21dB* when band is worn behind the head
- Noise Reduction Rating of 20dB* when band is worn under the chin
- Use with Replacement Pads 1311

Part Number	UPC Number	Each Per Box	Boxes Per Case
1310	051138-66003	10	5
1311	051138-66004	20	5

3M™ Reusable Ear Plugs 1260, 1270

- Triple-flange plugs securely fits into the ear canal for comfort and reliable protection
- Noise reduction rating of 24dB*
- 1270 has a braided cord for convenience



Part Number	UPC Number	Description	Pairs Per Box	Boxes Per Case
1260	051138-66226	Reusable	100	5
1270	051138-66228	Reusable, Corded	100	5

3M™ Foam Ear Plug Dispenser

- Dispenses 3M™ Foam Ear Plugs 1100 and 3M™ Soft Foam Ear Plugs 1120/37062.
- Durable, lightweight plastic dispenser mounts easily on the wall wherever protection from loud sounds is needed (mounting screws not included).
- Simple, one-handed operation.
- Sturdy optional base holds dispenser securely for use on tables, benches and flat surfaces.
- Holds up to 700 pair of ear plugs.



3M™ Foam Ear Plugs 1120, 1130

- Noise Reduction Rating of 28dB*
- Made of extra soft, very comfortable material
- Hypo-allergenic
- 1130 has a braided cord for convenience

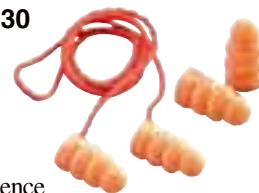

Part Number	Description	Pairs Per Box	Boxes Per Case
1120	Ear Plug	200	5
1130	Corded Ear Plug	100	5

Part Number	UPC Number	Description	Quantity Per Package	Packages Per Case
1100-DP	051131-91790	Dispenser Assembly w/1000 pair 1100 Foam Ear Plugs	—	—
1120-DP	051131-37151	Dispenser Assembly w/1000 pair 1120 Soft Foam Ear Plugs	—	—
1100-R	051131-91789	Refill, 1100 Foam Ear Plugs	500 pair/bag	4 bags
1120-R	051131-37152	Refill, 1120 Soft Foam Ear Plugs	500 pair/bag	4 bags
DSP-B	051131-37153	Optional heavy base for 3M Foam Ear Plug Dispenser	1 base/box	4 boxes

See page 124 for Important WARNINGS

* Research suggests that the Noise Reduction Rating (NRR) may overestimate the protection provided by hearing protectors during typical use. 3M recommends reducing the NRR by 50% for estimating the amount of noise reduction provided.

Important Warnings

	⚠ WARNING : Negative Pressure Respirators
	<p>Each respirator must be properly selected based on the contaminant and concentration levels to which the worker is exposed. Respirators shown in this catalog may be used for exposures below 10X the PEL or applicable government occupational exposure limits, whichever is lower.</p> <p>Failure to follow the use and fitting instructions and warnings for proper use contained on the respirator packaging and/or failure to wear the respirator during all times of exposure can reduce respirator effectiveness and may result in sickness or death. For proper use, see your supervisor. For more information, call 3M OH&ESD Technical Service at 1-800-243-4630. In Canada, call 1-800-267-4414.</p>

	⚠ WARNING : Positive Pressure Respirators
	<p>These respirators help reduce exposure to certain airborne contaminants. Use by untrained or unqualified persons, or use not in accordance with the instructions, may adversely affect product performance and result in sickness or death.</p> <p>3M™ Positive Pressure Respirators are to be used only by qualified persons properly trained in their use and maintenance, and only in accordance with their <i>User Instructions</i> provided as part of product packaging. Each person using these products must first read and understand the <i>User Instructions</i>. For proper use, see supervisor, packaging or call 3M OH&ESD Technical Service at 1-800-243-4630. In Canada, call 1-800-267-4414.</p>

⚠ WARNING : Head And Face Protection
<p>These safety products provide limited protection only. Misuse or failure to follow warnings and instructions may result in serious personal injury or death. For proper use, see supervisor, instructions and warnings, or call 3M OH&ESD Technical Service in U.S.A., 1-800-243-4630. In Canada, call 1-800-267-4414.</p>

⚠ WARNING : Protective Eyewear
<p>These safety products provide limited protection only. Do not use when performing torch burning, torch cutting, torch welding, electric (arc) welding, furnace corrections, molten metals operations, or any other operations which expose your eyes to harmful levels of infrared and ultra-violet radiation. Misuse or failure to follow warnings and instructions may result in serious personal injury, including blindness, or death. For proper use, see supervisor, product instructions and warnings or call 3M OH&ESD Technical Service at 1-800-243-4630. In Canada, call 1-800-267-4414.</p>

⚠ WARNING : Hearing Protection Products
<p>These hearing protection products help prevent hearing loss against certain noises. To provide proper protection, the hearing protector should be (1) suitable for the job, (2) fitted properly in/on the ear, (3) worn during all times of exposure to noise, and (4) replaced when damaged or otherwise necessary. Failure to fit and use hearing protectors according to these instructions will reduce their effectiveness. Failure to wear hearing protectors 100% of the time that you are exposed to hazardous noise may dramatically increase your risk of developing hearing loss. Keep ear plugs away from infants and small children. They may get caught in a child's windpipe.</p>

⚠ WARNING : Sorbents
<p>Failure to properly handle and dispose of sorbents contaminated by hazardous materials can result in serious physical injury or death and/or environmental harm. For proper handling, consult the Material Safety Data Sheet for the material absorbed, applicable safety and health standards, contact your supervisor, or call 3M.</p>

Personal Care Products

3M™ Paint Buster™ Hand Cleaner



3M™ Paint Buster™ Hand Cleaner is a cream type hand cleaner that offers superior performance in the removal of marine bottom and topside paints, primers, varnishes, fairing compounds, putties, adhesives and sealants from skin. 3M Paint Buster hand cleaner is non-toxic and non-caustic, enabling quick removal of marine repair and refinish materials from hands without the use of skin damaging solvents.

Part Number	Tube Size	Tubes/Case
051131-05975	10.5 fl. oz.	12

3M™ Nexcare™ Active™ Flexible Foam Bandages



3M™ Nexcare™ Active™ Flexible Foam Bandages feature an advanced moisture-resistant adhesive that provides extra sticking power on damp or sweaty skin. Bandage stays put during work and resists coming off when immersed in water. 3M Nexcare Active flexible foam bandages are made of a unique, flexible foam that stretches, flexes and conforms, unlike many conventional plastic bandages that can curl up, fall off or chaff the skin. The adhesive strip forms a frame around the pad to help seal out dirt and contaminants.

Part Number	Size	Each/Box	Box/Case
051131-62030	Assorted Pack:	45	24
	10 – 7/8" x 3" Strips		
	10 – 5/8" x 3" Strips		
	10 – 7/8" Spots		
	15 – 3/8" x 1-1/2" Strips		

3M™ Nexcare™ Waterproof Bandages



3M™ Nexcare™ Waterproof Bandages have a unique shape that provide superior waterproof protection even when showering and bathing. They help prevent infection by forming a barrier to keep bacteria from cuts, scrapes, burns, blisters and other minor injuries. 3M Nexcare waterproof bandages are made of ultra-thin, breathable material that bends and flexes as you move; the non-stick pad won't stick to the wound. These bandages are transparent and a perfect match to your skin.

Part Number	Size	Each/Box	Box/Case
051131-66427	Assorted Pack:	30	24
	15 – 7/8" Spots		
	10 – 1-1/16" x 2-1/4" Strips		
	5 – 1-1/4" x 2-1/2" Strips		

3M™ Ultrathon™ Insect Repellent



Rated #1 by a leading consumer magazine. Ultrathon's patented 3M Controlled Release Technology works for up to twelve hours — long after other repellents have dissipated. 3M™ Ultrathon™ Insect Repellent creates a barrier that repels mosquitos that may carry West Nile Virus, ticks that may carry Lyme Disease, plus biting flies, chiggers, and more. It also resists perspiration for extraordinary effectiveness.

Part Number	Tube Size	Tubes/Case
051131-67442	2 oz.	12

3M™ Nexcare™ Comfort Strips



Comfort strips have a soft, velvety material that stretches and conforms. It "breathes" even between the holes to help keep skin dry and cool. The unique air flow pattern allows sweat and moisture to evaporate. The extra stick adhesive resists loosening when wet. The adhesive around the pad area helps to "seal" out dirt and other contaminants.

Part Number	Size	Each/Box	Box/Case
051131-65289	Assorted Pack:	50	24
	10 – 3/4" x 3"		
	5 – 1" x 3"		
	10 – 5/8" x 2-1/4"		
	10 – spots		
15 – mini's			

Comfort Masks

3M™ 8661ES Comfort Mask

Lightweight, disposable masks offer relief from irritating effects of common household dusts. Patented filter media is greater than 90% efficient for particles of all sizes. Contour fit, soft metal nosepiece adjusts closely over the bridge of the nose.



Part Number	Masks/Pack	Packs/Case
8661ES	5	12

3M™ 8662ES Comfort Mask

Lightweight, disposable masks offer relief from irritating effects of common household dusts. Patented filter media is greater than 90% efficient for particles of all sizes. Contour fit, soft metal nosepiece adjusts closely over the bridge of the nose.



Part Number	Masks/Pack	Packs/Case
8662ES	5	12

Retail Packaged Safety Products

Protection for You

3M is a leading name in comfort masks and respirators. Wherever they are used, people in industry and at home recognize 3M Personal Safety Products for their quality and performance.

With the increased popularity in Do-It-Yourself activities and growing consumer awareness in health and safety, more knowledgeable consumers are demanding more effective Do-It-Yourself protection. So, it's important that you have the best protection possible. The 3M Personal Safety Products program assures you of that kind of protection.

3M™ R8511ES Woodworking/Sanding and Fiberglass Respirator

The 3M™ R8511ES Woodworking/Sanding and Fiberglass Respirator provides protection from dusts encountered during sanding jobs (wood or non-lead based fiberglass paint). U.S. government approved.



Part Number	Respirators/Pack	Packs/Case
R8511ES	1	12

3M™ 8654ES Sanding and Fiberglass Respirator

The 3M™ 8654ES Sanding and Fiberglass Respirator provides protection against dust encountered during sanding jobs.



Part Number	Respirators/Pack	Packs/Case
8654ES	2	12

3M™ R8515ES Welding Respirator

The 3M™ R8515ES Welding Respirator helps reduce exposure to fumes encountered during welding applications.



Part Number	Respirators/Pack	Packs/Case
R8515ES	1	12

3M™ 8656ES Latex Paint and Odor Respirator

The 3M™ 8656ES Latex Paint and Odor Respirator provides protection against sanding dust and fiberglass insulation dust, particle board, drywall compounds and painted surfaces. Meets requirements of NIOSH 42 CFR 84 N95. This respirator is 95% efficient against solid and liquid aerosols that do not contain oil.



Part Number	Respirators/Pack	Packs/Case
8656ES	1	12

3M™ 8660ES Welding Respirator

The 3M™ 8660ES Welding Respirator provides protection against dust from wood working, coal, iron ore, cotton, flour and certain other substances; mists from sprays that do not also produce vapors and do not contain oil; metal fumes from welding, brazing, cutting and other operations involving heating of metals. U.S. government approved.



Part Number	Respirators/Pack	Packs/Case
8660ES	1	6

3M™ H8750 Comfort Foam Ear Plugs

Protects ears from loud noises that can result in hearing loss.



Part Number	Pairs/Pack	Packs/Case
H8750	4	12

Retail Packaged Safety Products

3M™ Particulate Filter 2071, P95 – Retail Packaged

Lightweight and easy to use, the 3M™ Particulate Filter 2071, P95 is designed for applications such as grinding, sanding and welding. It provides approved protection in environments where oil aerosols may be present. Can be used with 3M™ 5000 Series Respirators when equipped with the 502 adapter (adapter must be ordered separately.)



Part Number	UPC Number	Each/Box	Box/Case
R2071	051138-76681	4	5

3M™ Particulate Filter 2091, P100 – Retail Packaged

Meets the NIOSH 42 CFR 84 filtration classification, P100. The 2091 does so with 3M's new Advanced Electret Media (AEM). Currently, it is the only filter not made from fiberglass components to achieve a P100 rating. Use for all applications that in the past required the use of dust/mist, dust/fume/mist class or HEPA-rated respiratory protection. The 2091 is lightweight, versatile, simple to use, compatible, exceptionally efficient respiratory filter and priced competitively.



Part Number	UPC Number	Each/Box	Box/Case
R2091	051138-76582	4	5

3M™ Paint Spray Replacement 6000 Series – Retail Packaged

Cartridge can be used with 3M™ 6000 Series Half Facepiece and Full Facepiece Respirator with bayonet attachment.



Part Number	UPC Number	Each/Case
R6022	051138-54270	5

3M™ Replacement Lens Covers 6000 Series – Retail Package

Faceshield cover for use with the 3M™ 6000 Series Full Facepiece Respirator.



Part Number	UPC Number	Each/Bag	Bags/Case
R6885ES	051131-52634	25	4

3M™ Ear Muff 1425 – Retail Package

Lightweight, economical ear muffs designed for comfort and durability in most work environments. Individually carded for retail sale.



Part Number	UPC Number	Each/Bag	Bags/Case
R1425ES	051131-52600	1	10

3M™ Ear Muff 1427 – Retail Package

A combination of versatility and performance. The rotating headband and adjustable head strap make it easy to obtain a secure fit in any of three different positions. Individually carded for retail sale.



Part Number	UPC Number	Each/Bag	Bags/Case
R1427ES	051131-52601	1	10

3M™ Visitor Specs 1611 Clear – Retail Package

3M™ Visitor Specs provide eye protection for temporary visitors, and short term users. Can be worn alone or over prescription glasses. Individually carded for retail sale.

Part Number	UPC Number	Bags/Case
R1611ES	051131-52522	10

3M™ Safety Goggles 1620 Perforated – Retail Package

3M™ Safety Goggles are perforated, soft and comfortable with flexible vinyl frames. These are goggles for general use and should not be worn in areas where chemical splashes and fumes may be present. Individually carded for retail sale.

Part Number	UPC Number	Bags/Case
R1620ES	051131-52523	15

3M™ Safety Goggles 1621 Splash-Proof – Retail Package

3M™ Safety Goggles, Splash-Proof have a polycarbonate lens to protect against chemical splashes. Pliable vinyl frames provide comfortable fit and vents enhance air circulation to prevent fogging. Individually carded for retail sale.

Part Number	UPC Number	Bags/Case
R1621ES	051131-52524	15

Retail Packaged Safety Products

3M™ Boas™ Protective Eyewear – Retail Package

3M™ Boas™ Protective Eyewear have UV Protection up to 99%. They are lightweight and designed for worker acceptance. Lens made of durable, hardcoated polycarbonate. For outdoor or bright environments. The R-1701ES style has a tinted lens. Individually carded for retail sale.

Part Number	UPC Number	Each/Case
R1700ES	051131-52526	10
R1701ES	051131-52527	10

3M™ Sting-Rays™ Protective Eyewear – Retail Package

3M™ Sting-Rays™ Protective Eyewear have lightweight, contemporary style frames that offer side and brow protection. The lenses are made of durable, hardcoated polycarbonate. The R-1712ES style has a tinted lens. Individually carded for retail sale.

Part Number	UPC Number	Each/Case
R1710ES	051131-52528	10
R1712ES	051131-52529	10

3M™ Lazers™ Protective Eyewear – Retail Package

3M™ Lazers™ Protective Eyewear have a wraparound design with a non-slip rubber headgrip for added comfort. The R-1721ES style has a mirrored lens. Individually carded for retail sale.

Part Number	UPC Number	Each/Case
R1720ES	051131-52530	10
R1721ES	051131-52531	10

3M™ Faceshield Kit – Retail Package

3M™ Faceshield Kit uses replaceable polycarbonate material for clearer vision. The cam-lock feature holds the faceshield in place. It uses a slide adjustment for easy sizing. Packaged one per header carded bag for retail sale.

Part Number	UPC Number	Kits/Case
R1631ES	051131-52525	5

3M™ Head Protection Products – Retail Package

3M™ Head and Face Protection Products are designed to enhance safety in the work place. In addition, they combine personal comfort, and a fashionable appearance with overall value. All 3M head protection products feature lightweight, high-density polyethylene molding, fully cushioned brow pads for moisture absorption, a 6-point suspension and compliance with ANSI Z89.1-1997 Type 1, Class C, E, and G requirements. Omega II Hard Hats – standard slide suspension adjusts to fit sizes 6-1/2 to 7-1/4. Ratchet suspension fits 5-1/8 to 8. Ratchet has soft removable head band for maximum adjustability and comfort. Key advantages are: meets ANSI requirements, available in variety of colors, styles and suspensions, can be worn backwards by adjusting suspension, front brimmed or full brim styles available. Individually carded for retail sale.

Part Number	UPC Number	Description	Each/Case
R1911ES	051131-52532	Omega II™ Hard Hat, White, Ratchet Suspension	8
R1912ES	051131-52533	Omega II™ Hard Hat, Yellow, Ratchet Suspension	8
R1921ES	051131-52534	Hard Hat, White	8
R1922ES	051131-52535	Hard Hat, Yellow	8
R1931ES	051131-52536	Full Brim Hard Hat, White, Ratchet Suspension	8

3M™ 7500 Professional Series Organic Vapor P95 Half Mask Respirator Packout – Retail Package



The 3M™ Professional Series Organic Vapor P95 Packout is 3M recommended for paint spray applications. Packouts include the ultracomfortable Professional Series Facepiece, two 6001 organic vapor cartridges, four 5P71, P95 filters and two 501 retainers.

Part Number	UPC Number	Description	Each/Case
R7511ES	051131-52764	Small Respirator Packout	4
R7512ES	051131-52765	Medium Respirator Packout	4
R7513ES	051131-52766	Large Respirator Packout	4

3M™ Professional Series Half Facepiece Respirator Rebuild Kit

Includes replacement parts to maintain the durable respirator facepiece.

Part Number	UPC Number	Description	Packouts/Case
R7530ES	051131-52767	Kit	5

Floor and Deck Matting

3M™ Nomad™ Scraper Matting 6050

A non-woven open matting formed of continuous vinyl filaments that has an integral fused, all-vinyl foam backing forming a comfortable, cushioned walking surface. It provides anti-fatigue as well as dirt trapping and collecting properties.

Part Number	Color	Each/Case
Non-Embossed "Standard Mat"		
22" x 34"		
048011- 26442	Blue	6
048011- 26440	Cabernet	6
048011- 26441	Chesnut (Dk. Brown)	6
048011- 26182	Concrete (Lt. Gray)	6
048011- 26183	Dove (Brown)	6
048011- 26436	Ebony	6
048011- 26443	Silver	6
048011- 26439	Slate (Gray)	6
048011- 26437	Spruce	6
3' x 5'		
048011- 26449	Blue	1
048011- 26447	Cabernet	1
048011- 26448	Chesnut (Dk. Brown)	1
048011- 26186	Concrete (Lt. Gray)	1
048011- 26187	Dove (Brown)	1
048011- 17780	Ebony	1
048011- 26451	Forest	1
048011- 17580	Red	1
048011- 26446	Seagrass	1
048011- 26450	Silver	1
048011- 26445	Slate (Gray)	1
3' x 10'		
048011- 29566	Slate (Gray) — with Nozing	1
3' x 20'		
048011- 26243	Blue	1
048011- 26240	Dove (Brown)	1
048011- 26246	Ebony	1
048011- 26242	Forest	1
048011- 26239	Slate (Gray)	1
4' x 6'		
048011- 26456	Blue	1
048011- 26453	Cabernet	1
048011- 26455	Chesnut (Dk. Brown)	1
048011- 26188	Concrete (Lt. Gray)	1
048011- 26189	Dove (Brown)	1
048011- 17790	Ebony	1
048011- 26458	Forest	1
048011- 17788	Red	1
048011- 26454	Seagrass	1
048011- 26457	Silver	1
048011- 26452	Slate (Gray)	1
4' x 20'		
048011- 26272	Blue	1
048011- 26275	Dove (Brown)	1
048011- 26269	Ebony	1
048011- 26273	Forest	1
048011- 26276	Slate (Gray)	1

3M™ Nomad™ Scraper Matting 8100

Combines vinyl loops that scrape dirt and moisture from shoes with an unbacked construction that makes it easy to clean up the debris that falls through the mat. This grease- and oil-resistant matting is designed for exterior facility entrances or recessed wells.



Part Number	Color	Each/Case
3' x 5'		
048011- 29467	Concrete (Lt. Gray)	1
048011- 29462	Dove (Brown)	1
048011- 29466	Ebony	1
048011- 29463	Red	1
4' x 6'		
048011- 29464	Concrete (Lt. Gray)	1
048011- 29469	Dove (Brown)	1
048011- 29468	Ebony	1
048011- 29465	Red	1
4' x 20'		
048011- 34501	Dove (Brown) — Unbacked	1
048011- 34635	Slate (Gray) — Unbacked	1

Floor and Deck Matting

3M™ Nomad™ Scraper Matting 8150

Combines vinyl loops that scrape dirt and moisture from shoes with a durable backing that keeps dirt and moisture from falling through the mat onto the floor underneath. This grease- and oil-resistant matting is designed for exterior or interior facility entrances or recessed wells.



Part Number	Color	Each/Case
3' x 5'		
048011- 26468	Blue	1
048011- 26466	Cabernet	1
048011- 26467	Chesnut (Dk. Brown)	1
048011- 29474	Dove (Brown)	1
048011- 29473	Ebony	1
048011- 26470	Forest	1
048011- 29477	Red	1
048011- 26465	Seagray	1
048011- 26469	Silver	1
048011- 26464	Slate (Gray)	1
4' x 6'		
048011- 26481	Blue	1
048011- 26479	Cabernet	1
048011- 26480	Chesnut (Dk. Brown)	1
048011- 29476	Concrete (Lt. Gray)	1
048011- 29471	Dove (Brown)	1
048011- 29470	Ebony	1
048011- 26483	Forest	1
048011- 29472	Red	1
048011- 26478	Seagray	1
048011- 26482	Silver	1
048011- 26477	Slate (Gray)	1
3' x 20'		
048011- 34563	Dove (Brown) — Backed	1
048011- 34562	Slate (Gray) — Backed	1
4' x 20'		
048011- 34556	Dove (Brown) — Backed	1
048011- 34557	Slate (Gray) — Backed	1

3M™ Safety-Walk™ Matting Wet Area Matting 1500

Also known as 3M™ Nomad™ Medium Traffic Unbacked Matting; 3M™ Safety-Walk™ Wet Area Matting 1500 has an open, coiled vinyl construction allowing water to drain through, making it ideal for locker rooms, shower areas and around saunas. The cushioned vinyl loops provide comfort for barefoot traffic. Antimicrobial coating provides resistance to mildew, fungus and odors in the mat. This matting is easy to maintain – just clean by shaking or washing with a hose or power washer.



Part Number	Color	Size	Each/Case
048011- 17635	Spruce	3' x 20'	1
048011- 17636	Blueberry	3' x 20'	1

3M™ Safety-Walk™ Matting Wet Area Matting 3200

Also known as 3M™ Entrap™ Wet Area Matting; 3M™ Safety-Walk™ Wet Area Matting 3200 is ideal for pool/whirlpool areas, locker rooms, shower areas and around saunas. The open, vinyl Z-web design allows liquids and small debris to fall through, helping to reduce slips and falls. The matting has an antimicrobial coating providing resistance to mildew, fungus and odors in the mat. The open, Z-web construction provides a barefoot slip-resistant surface for wet areas. The matting's surface spacing and design provides uniform foot support.

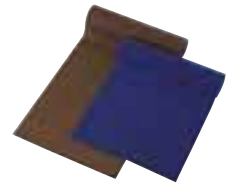

Part Number	Color	Size	Each/Case
048011- 13722	Blue	3' x 20'	1
048011- 13723	Wheat	3' x 20'	1
048011- 16107	Blue	3' x 10'	1
048011- 16108	Wheat	3' x 10'	1

Floor and Deck Matting

3M™ Nomad™ Carpet Matting 4000

3M™ Nomad™ Carpet Matting 4000 is a ribbed product that removes dirt and water from foot traffic. This product is suitable for entryways of low traffic facilities.



Part Number	Color	Each/Case
2' x 3'		
048011- 23749	Brown	6
048011- 23748	Charcoal	6
048011- 23764	Cranberry	6
048011- 23750	Lt. Gray	6
3' x 5'		
048011- 23768	Brown	1
048011- 23767	Charcoal	1
048011- 23766	Cranberry	1
048011- 23322	Hunter Green	1
048011- 23769	Lt. Gray	1
3' x 10'		
048011- 23773	Brown	1
048011- 23771	Charcoal	1
048011- 23770	Hunter Green	1
048011- 23774	Lt. Gray	1
4' x 6'		
048011- 23791	Brown	1
048011- 23790	Charcoal	1
048011- 23788	Cranberry	1
048011- 23789	Hunter Green	1
048011- 23793	Lt. Gray	1
4' x 10'		
048011- 23796	Charcoal	1
048011- 23795	Cranberry	1
048011- 23794	Hunter Green	1
048011- 23798	Lt. Gray	1

3M™ Enhance™ Matting 850

Also known as 3M™ Nomad™ Carpet Matting 8850. Features a patented dual-fiber design; large, crush-resistant polypropylene fibers that scrape, remove and hide loose dirt; and small nylon fibers that wick away water from foot and wheeled traffic for heavy traffic entryways.



Part Number	Color	Each/Case
2' x 3'		
048011- 20642	Ebony	6
048011- 23415	Spruce	6
3' x 5'		
048011- 23417	Blueberry	1
048011- 23418	Burgundy	1
048011- 20529	Checkers (Green/Red)	1
048011- 20544	Dove (Brown)	1
048011- 20583	Ebony	1
048011- 20559	Slate (Gray)	1
3' x 10'		
048011- 23421	Blueberry	1
048011- 23419	Burgundy	1
048011- 20531	Checkers (Green/Red)	1
048011- 20546	Dove (Brown)	1
048011- 20585	Ebony	1
048011- 20561	Slate (Gray)	1
048011- 23420	Spruce	1
4' x 6'		
048011- 23432	Blueberry	1
048011- 23431	Burgundy	1
048011- 20530	Checkers (Green/Red)	1
048011- 20545	Dove (Brown)	1
048011- 20584	Ebony	1
048011- 20560	Slate (Gray)	1
048011- 23430	Spruce	1
4' x 8'		
048011- 20550	Dove (Brown)	1
048011- 20565	Slate (Gray)	1
048011- 20589	Ebony	1
048011- 23433	Blueberry	1
048011- 23434	Burgundy	1
4' x 10'		
048011- 23438	Blueberry	1
048011- 23437	Burgundy	1
048011- 20536	Checkers (Green/Red)	1
048011- 20551	Dove (Brown)	1
048011- 20590	Ebony	1
048011- 20566	Slate (Gray)	1
048011- 23436	Spruce	1
6' x 10'		
048011- 23387	Blueberry	1
048011- 23449	Burgundy	1
048011- 20540	Checkers (Green/Red)	1
048011- 20555	Dove (Brown)	1
048011- 20594	Ebony	1
048011- 20570	Slate (Gray)	1
048011- 23448	Spruce	1

Floor and Deck Matting Accessories

3M™ Matting Seaming Tape Kit

Kit consists of: 10 foot vinyl and 1 tube adhesive.

Part Number	Color	Kits/Case
048011-08148	Brown	10

3M™ Matting Seaming Tape

Part Number	Color	Roll Size	Rolls/Case
048011-09457	Brown	100 ft.	5

3M™ Edging Adhesive



Part Number	Size	Tubes/Case
048011-08554	3 oz. Tube	12

3M™ Scotchlite™ and Diamond Grade Reflective Products

3M™ Scotchlite™ Reflective Safety Tape

Composed of a highly flexible, durable, adhesive coated sheeting designed for areas that require bright night-time light reflectivity needed to increase safety. Examples include: trailers, driveways, mailboxes, bicycles, farm equipment, RVs and watercraft. In addition, they can be used at the marina or boat docking location to increase awareness and safety. For best results the surfaces should be smooth and clean. The tape will work on metal, glass, fiberglass, wood, and painted surfaces. **NOTE: FOR LIFE SAVING EQUIPMENT SUCH AS LIFE VESTS, JACKETS, LIFERINGS, LIFEBOATS, AND LIFERAFTS, 3M™ SCOTCHLITE™ REFLECTIVE SHEETING HIGH INTENSITY SOLAS GRADE SERIES 3150A IS RECOMMENDED.**



Part Number	Color	Size	Packs/Case
051131-03455	Silver	1" x 36"	24
051131-03458	Red	1" x 36"	24
051131-03456	Silver	2" x 36"	24
051131-03459	Red	2" x 36"	24
051131-03460	Kit/Red	4" x 4.75"	24

3M™ High Intensity SOLAS Grade Scotchlite™ Reflective Sheeting 3150A

3M™ High Intensity SOLAS (Safety Of Life At Sea) Grade Scotchlite™ Reflective Sheeting 3150A is a flexible, encapsulated lens, highly-reflective material, precoated with an improved aggressive pressure-sensitive adhesive. The sheeting remains highly reflective when totally wet as well as when viewed at wide entrance angles. The reflective sheeting is designed for nighttime visibility of life support equipment. It conforms well for application on flexible or rigid substrates used in life support equipment (life rafts, jackets, vests, etc). The sheeting has been successfully applied to most nylon, cotton, rubber and laminated or coated combinations of these materials normally used in the manufacture of life support equipment. Material is Coast Guard and IMO Certified.



Part Number	Size	Rolls/Case
051131-88619*	50.8mm x 50m	1
051131-88622**	76.2mm x 50m	4
051131-88624***	101.6mm x 50m	3

* Metric Replacement for PN67119

** Metric Replacement for PN67480

*** Metric Replacement for PN67479

3M™ Diamond Grade High Visibility Reflective Safety Strips

A highly reflective prismatic sheeting that is backed with a pressure-sensitive adhesive and clear poly liner. Applied to properly prepared substrates, Diamond Grade sheeting should provide seven-year field performance. The 18" strips incorporate an 11" red/7" white pattern. The 12" strips have a 6" red/6" white configuration. These strips are easy to apply and have durable presealed edges. They are non-metallic to prevent corrosion. Uses include boat trailers, docks, watercraft, ATVs, and snowmobiles. Approved and certified for the Department of Transportation.



Part Number	Color	Size	Packs/Case
051131-03461	Alt. Red/White	2" x 18" (2 Strips)	24
051131-03462	Alt. Red/White	2" x 18" (4 Strips)	24
051131-03463	Alt. Red/White	2" x 12" (2 Strips)	24
051131-03464	Alt. Red/White	2" x 12" (4 Strips)	24

3M™ Diamond Grade Conspicuity Sheeting Series 983

Responds to the need for improved safety with 2" wide rolls of an alternating red and white reflective tape. Excellent for boats, trailers, docks, etc. Easy to apply, highly reflective.



Part Number	Color	Roll Size	Rolls/Case
051138-67533	Red 11", White 7"	2" x 150'	1
051138-67535	Red 6", White 6"	2" x 150'	1
051138-67537	White	2" x 150'	1
051138-67885	Yellow	2" x 150'	24

3M™ Photoluminescent Film 6900

The ideal interior safety, emergency exit, and evacuation marking for ships, passenger vessels, airplanes, trains, and buildings. This new luminous film meets and exceeds specification ASTM 2072 for luminosity. Luminous film 6900 may be used to mark exits, doorways, stairways, hatchways, floors and ceilings — any surface that needs to direct or inform people during emergency or lights-out conditions. Luminous film 6900 is easy to apply and is warranted for 7 years.



Part Number	Roll Size	Rolls/Case
051135-27725	1" x 10 yds.	6
051135-27726	2" x 10 yds.	3
051135-27727	3" x 10 yds.	2

3M™ Scotchlite™ and Diamond Grade Reflective Products

3M™ Marine SOLAS Grade Scotchlite™ Reflective Material

3M™ Marine Scotchlite™ SOLAS (Safety Of Life At Sea) Grade High Intensity Reflective Material is a flexible, encapsulated lens, high-reflective material, precoated with an improved aggressive pressure-sensitive adhesive. The sheeting remains highly reflective when totally wet as well as when viewed at wide entrance angles. The reflective sheeting is designed for nighttime visibility of life support equipment. It conforms well for application on flexible or rigid substrates used in life support equipment (life rafts, jackets, vests, etc.). The sheeting has been successfully applied to most nylon, cotton, rubber and laminated or coated combinations of these materials normally used in the manufacture of life support equipment. Material is Coast Guard and IMO Certified. Retail packaged.



Part Number	Description	Packs/Case
051131- 88418	12 – 2" x 4" strips per pack	6

3M™ Vanguard™ Lenses

3M™ Vanguard™ Lenses

Wide-angle window lenses reduce the chance of squeeze accidents caused by blind spots. Excellent for use when towing trailered boats. Made of thin flexible plastic, these lenses provide an extreme wide angle view. Obstacles can be seen, right down to the pavement; areas rear view mirrors miss. 3M™ Vanguard™ Lenses are easily applied and removed by hand using water only and they won't damage the glass.



Part Number	Description	Roll Size	Rolls/Case
051131- 07950	3M™ Vanguard™ Lenses	8" x 10"	12
051131- 07951	3M™ Super Vanguard™ Lenses	11" x 14"	12
051131- 07952	3M™ Vanguard™ 2 Lenses	6" x 8"	12

Electrical Products

Scotch® Super 33 Plus Vinyl Plastic Electrical Tape

A professional grade all-weather tape; has excellent resistance to flame, abrasion, moisture, alkalis, solvents, oil and many acids. Gives full electrical and mechanical protection. 7-mil.



Part Number	Size	Rolls/Box	Boxes/Case
054007-06130	3/4" x 20'	10	10
054007-10075	3/4" x 44'	10	10
054007-06132	3/4" x 66'	10	10
054007-06133	3/4" x 52'	10	10
054007-10216	3/4" x 66' D	10	10

D = Cutter Dispenser

Scotch® Super 88 Vinyl Plastic Tape

An 8.5-mil vinyl tape recommended for cold weather applications when conventional plastic tapes become brittle and stiff. Extra thickness provides increased abrasion resistance. U.L. listed.



Part Number	Size	Rolls/Box	Boxes/Case
054007-10307	3/4" x 44'	10	10
054007-06143	3/4" x 66'	10	10

Scotch® 35 Vinyl Electrical Tape – for Color Coding

This tape is the electrician's safety tool in a roll. Use it for phase identification, marking of motor leads and piping systems and for outlining safety areas. It is available in assorted colors. Also used as a rigging tape.



Part Number	Color	Size	Rolls/Case
054007-10810	Red	3/4" x 66'	10
054007-10828	White	3/4" x 66'	10
054007-10836	Blue	3/4" x 66'	10
054007-10851	Green	3/4" x 66'	10

Highland™ Vinyl Electrical Tape

A commercial grade tape that is 7 mils thick, tough and stretchy. Each roll cellophane wrapped. U.L. listed.



Part Number	Size	Rolls/Sleeve	Boxes/Sleeves
054007-16720	3/4" x 66'	10	10

Temflex™ 1700 Vinyl Electric Tape

Economy grade tape that is 7 mils thick.

Part Number	Size	Sleeves/Box	Boxes/Case
054007-49700	3/4" x 66'	10	10
054007-49571	3/4" x 66'	10	10

Scotch® 2200 Vinyl Mastic Pads

Self-fusing, rubber-based insulating compounds laminated to a flexible, all-weather grade PVC backing. Pads are resistant to abrasion, moisture, alkalis, acid, copper corrosion, ultraviolet (U.V.) and varying weather conditions. Another option for insulating wire connections against moisture and corrosion.



Part Number	Size	Pads/Box	Pads/Case
054007-11008	3-1/4" x 4-1/2"	10	50
054007-21296	6-1/2" x 4-1/2"	10	50

Scotch® 2210 Vinyl Mastic Rolls

Self-fusing, rubber-based insulating compounds laminated to a flexible, all-weather grade PVC backing. Rolls are resistant to abrasion, moisture, alkalis, acid, copper corrosion, ultraviolet (U.V.) and varying weather conditions. Another option for insulating wire connections against moisture and corrosion.



Part Number	Size	Rolls/Box	Boxes/Case
054007-11222	4" x 10'	1	10

Scotch® 2242 Linerless Splicing Compound

Designed to offer the ultimate in protection of electrical wiring and connectors from shorts and failures caused by moisture and corrosion. It is self-bonding, moisture resistant, weather resistant – will not crack or embrittle in ultraviolet light or cold temperature.



Part Number	Size	Rolls/Case
051131-06165	3/4" x 15'	24

Scotch® 2228 Rubber Mastic Tape

Made of a self-fusing, rubber-based insulating compound. Scotch® 2228 is laminated to an Ethylene Propylene Rubber (EPR) backing that offers moisture resistance and an ability to easily stretch the tape.



Part Number	Thickness	Roll Size	Rolls/Case
054007-50727	65mils	1" x 10'	12
054007-09656	65mils	2" x 10'	10

Electrical Products

3M™ ScotchCode™ Wire Marker Tape Dispenser



Provides a fast, convenient system for marking wire, cable, or vacuum hoses. Using the special end loop, it can be hooked on belt or tool pouch. The small size also makes it easy to carry in a pocket or tool box – always at hand. The 10 refillable compartments allow you to choose the exact number or color combinations you need. Numbered dispenser filled with numbers 0 thru 9, colored dispenser filled with assorted colors.

Part Number	Description	Each/Case
054007- 49518	Filled Number Dispenser	10
054007- 49517	Filled Color Coded Dispenser	10
054007- 49519	Empty Dispenser (Either Color or Numbers)	10

3M™ Scotchlok™ TH-450 Scissors Style Crimping Tool



3M's most versatile and heavy-duty tool. Made of high-strength-heat-treated carbon steel, the TH-450 is lightweight without sacrificing strength. It handles a variety of terminal and conductor styles, including flags, closed-end connectors, crimp sleeves and standard parts, both insulated and non-insulated. With a range of 26 – 6 AWG wire size, connections are U.L. approved when the crimping process is completed and the tool releases.

Part Number	Wire Range	Tools/Case
054007- 13760	26 – 6	10

3M™ ScotchCode™ Wire Marker Tape



This tape is a 5.5-mil reinforced, flame-retardant epoxy film tape with an acrylic, high tack pressure-sensitive adhesive. Tape resists abrasion, oil and water and adheres to clean neoprene, Hypalon®, nylons and PVC insulation materials. Non-smear identification for all marking jobs. Available in numbers 0 thru 9 and the 10 assorted colors listed below.

Part Number	Description	Packs/Case
Numbers		
054007- 09368	0 thru 9	1

Part Number	Description	Rolls/Case
054007- 09369	0	10
054007- 09370	1	10
054007- 09371	2	10
054007- 09372	3	10
054007- 09373	4	10
054007- 09374	5	10
054007- 09375	6	10
054007- 09376	7	10
054007- 09377	8	10
054007- 09378	9	10

Part Number	Description	Packs/Case
Colors		
054007- 09404	Assortment	1

Part Number	Description	Rolls/Case
054007- 09423	Black	10
054007- 09424	Blue	10
054007- 09425	Brown	10
054007- 09426	Green	10
054007- 09427	Gray	10
054007- 09428	Orange	10
054007- 09429	Red	10
054007- 09430	White	10
054007- 09431	Yellow	10
054007- 09458	Violet	10

Hypalon® is a registered trademark of DuPont Dow Elastomers.

Electrical Products

3M™ EPS-300 Heat Shrink Tubing

Oil protection for electronic components, wire splices, wire bundles, and harness breakouts. 3M™ EPS-300 is a superb insulator that also functions as a strain relief and an environmental seal.



Part Number	Color	Size	Pieces/ Box	Boxes/ Box
051135- 36875	Black	3/16" x 4'	10	1
051135- 36876	Black	1/4" x 4'	10	1
051135- 36877	Black	3/8" x 4'	10	1
051135- 36878	Black	1/2" x 4'	10	1
051135- 36879	Black	3/4" x 4'	5	1
051135- 36880	Black	1" x 4'	5	1
051135- 36881	Black	1-1/2" x 4'	5	1

3M™ EPS-300 Heat Shrink Tubing Kit

An assortment of adhesive-lined, flexible, polyolefin heat shrink tubing. Each box is 7" x 11" x 2-1/2" of rugged translucent plastic with product and installation information on the cover. Refill packs are available for the individual components. The kit contains 42 pieces (6" lengths) that are listed by expanded diameter:



Part Number	Kit Contents	Pieces/ Kit	Kits/ Case
051135- 38444	1/2" (12.70mm), 12 pieces, Red	42	5
	1/2" (12.70mm), 12 pieces, Black		
	3/4" (19.05mm), 6 pieces, Red		
	3/4" (19.05mm), 6 pieces, Black		
	1" (25.40mm), 3 pieces, Red		
1" (25.40mm), 3 pieces, Black			

3M™ Kynar® Heat Shrink Tubing

A higher performance tubing good for engine compartment applications. This tubing has outstanding abrasion resistance, is inherently flame retardant and highly resistant to most industrial fuels, chemicals and solvents. The shrink ratio is 2:1 and the color is clear.



Part Number	Color	Size	Pieces/ Box	Boxes/ Box
051135- 36886	Clear	3/64" x 4'	25	1
051135- 36887	Clear	1/16" x 4'	25	1
051135- 36888	Clear	3/32" x 4'	25	1
051135- 36889	Clear	1/8" x 4'	25	1
051135- 36890	Clear	3/16" x 4'	12	1
051135- 36891	Clear	1/4" x 4'	12	1
051135- 36892	Clear	3/8" x 4'	12	1
051135- 36893	Clear	1/2" x 4'	5	1
051135- 36894	Clear	3/4" x 4'	5	1

Kynar® is a registered trademark of Elf Atochem North America, Inc.

3M™ FP301 Heat Shrink Tubing Refill Packs



Part Number	Refill Pack Contents	Packs/ Case
051135- 36618	3/32" (2.36mm) 35 pieces, 7 color	10
051135- 36619	1/8" (3.18mm) 28 pieces, 7 colors	10
051135- 36620	3/16" (4.75mm) 21 pieces, 7 colors	10
051135- 36621	1/4" (6.35mm) 21 pieces, 7 colors	10
051135- 36622	3/8" (9.53mm) 14 pieces, 7 colors	10
051135- 36623	1/2" (12.70mm) 14 pieces, 7 colors	10

Electrical Products

3M™ Cold Shrink Tubing 8420 & 8430 Series — EPDM Rubber 8440 Series — Silicone Rubber



An open-ended rubber sleeves which are factory expanded and assembled onto removable plastic cores. The core is removed after the tube has been positioned for installation over an inline connection, coupling cable or termination, allowing the tube to shrink and form a water-resistant seal. With 3M™ Cold Shrink Tubing you get a water-resistant seal without heat, torches or adhesives. Simply unwind the core to install, it's that simple.

Part Number	Catalog Number	Insulation Range	Tube Length	Each/Case
Connector Insulators (EPDM)				
054007-42146	8423-6	.31 – .56	6"	10
054007-42390	8424-8	.10 – .82	8"	10
054007-42391	8425-8	.40 – .82	8"	10
054007-34457	8426-9	.55 – 1.18	9"	10
054007-34458	8426-11	.55 – 1.18	11"	10
054007-09915	8427-6	.67 – 1.38	6"	10
054007-34459	8427-12	.67 – 1.38	12"	10
054007-34460	8427-16	.67 – 1.38	16"	10
054007-09916	8427-6	.95 – 1.94	6"	10
054007-09056	8428-12	.95 – 1.94	12"	10
054007-34461	8428-18	.95 – 1.94	18"	10
054007-00917	8429-6	1.27 – 2.67	6"	10
054007-09931	8429-9	1.27 – 2.67	9"	10
054007-42389	8429-12	1.27 – 2.67	12"	10
054007-34462	8429-18	1.27 – 2.67	18"	10
054007-42147	8430-9	1.68 – 3.69	9"	10
054007-42388	8430-18	1.68 – 3.69	18"	10
Silicone Insulators				
054007-09485	8443-2	.31 – .56	2"	12
054007-09482	8443-6.5	.10 – .82	6.5"	12
054007-09486	8445-2.5	.40 – .82	2.5"	12
054007-09483	8445-7.5	.55 – 1.18	7.5"	12
054007-09487	8447-3.2	.55 – 1.18	3.2"	12
054007-09484	8447-8	.67 – 1.38	8"	12

Scotch® Electrical Moisture Sealant Compound



Provides a quick and easy method of moisture proofing electrical connections. The master forms a moisture tight seal around connections and the tough elastic vinyl backing provides additional protection against vibration. Also can be used for wire repair, sealing lights and protecting terminal blocks. Designed for moisture sealing of electrical connections up to 600 volts.

Part Number	Size	Pieces/Box	Boxes/Box
054007-06147	2-1/2" x 10 ft.	1	10

Scotch® Electrical Moisture Sealant Pads



Now available in 2-1/2" x 2-1/2" patches. These patches can be used in place of tape to give connections all season/all weather protection and applies in less time. The tough vinyl backing prevents abrasion and protects against all common marine elements. In addition to providing a moisture-proof barrier for connections, these patches can be used for wire repair, sealing lights and protecting terminal blocks. Designed for moisture sealing of electrical connections up to 600 volts.

Part Number	Size	Pieces/Box	Boxes/Box
054007-06149	2-1/2" x 2-1/2"	25	10

3M™ Scotchkote™ Electrical Coating

This fast-drying coating provides extra protection to splices where moisture, oil and corrosive conditions can cause problems. Helps prevent cable and connector damage due to corrosive vapors from battery outgassing.



Part Number	Container Size	Cans/Case
054007-14853	15 fl. oz. Can	10

3M™ Scotchlok™ Bullet Receptacle Connector

Designed to allow quick connect, quick disconnect of the electrical system. This connector attaches quickly and easily with no wire stripping to any 14, 16 or 18 gauge copper wire operating at 48 volts or below. With no special tools except a pair of pliers the receptacle connector attaches to the wiring and connects to most standard bullet connectors. Mates with 3M™ Scotchlok™ Snap Plug (Bullet) Terminal (PN06108) and all standard .157" bullet terminals.

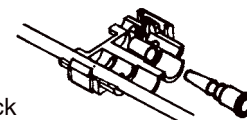

Part Number	Connector Number	Connectors/Box	Boxes/Case
054007-06106	901	50	10

3M™ Scotchlok™ Snap Plug (Bullet) Terminal

A vinyl insulated bullet terminal which can be permanently attached to any 14,16 gauge copper wire. This male snap plug is designed to be mated with our type 901 3M™ Scotchlok™ Bullet Receptacle Connector (PN06106).



Part Number	Connector Number	Connectors/Box	Boxes/Case
054007-06108	C-41-1101	100	500

Electrical Products

3M™ Scotchlok™ 314 Electrical Connector

Connectors contain a special compound inside the connector to protect against corrosion in damp conditions. Handles 22-14 AWG solid or stranded wire. Wires are held with a double “U” element to provide a much stronger connection while reducing electrical resistance.



Part Number	Connectors/Box	Boxes/Case
Boxed		
054007-09230	50	10
Part Number		
Connectors/Bag		
Bags/Case		
Bulk		
054007-09231	1000	1

3M™ Scotchlok™ 804 Instant Moisture Resistant Auto-Electric Connectors

Connectors make inline, pigtail and tap splices on solid or stranded wire with no wire cutting or stripping. With a standard pair of pliers any boat or trailer wiring job can be installed faster and easier with less training than any method previously used. The 804 Connector is listed by Underwriters Laboratories. Wire range Tap-run is 14 to 14, 16 to 16 and 18 to 18. Color: Blue.



Part Number	Connectors/Box	Boxes/Case
Boxed		
054007-06134	25	10
Part Number		
Connectors/Bag		
Bags/Case		
Bulk		
054007-06135	500	10

3M™ Scotchlok™ Instant Electric Connectors

Connectors make inline, pigtail and tap splices on solid or standard wire with no stripping. With a standard pair of pliers any wiring job can be installed easier and faster.



Part Number	Connector Number	Color	Wire Range Tap Run
054007-06118	564	White	14 14 16 to 16 18 18
054007-06119	902*	Brown	12 10 16 to 12 18
054007-06122	903*	Yellow	10 10 12 to 12
054007-06126	801*	Blue	14 14 16 to 16 18 18
054007-06127	905*	Red	14 18 to 16 22 18

* These connectors are listed by Underwriter's Laboratory.

Part Number	Connector Number	Connectors/Box	Boxes/Case
Boxed			
054007-06119	902	50	10
054007-06122	903	50	10
054007-06126	801	50	10
054007-06128	905	50	10

Part Number	Connector Number	Connectors/Bag	Connectors/Case
Bulk			
054007-06118	564	500	5000
054007-06120	902	1000	1000
054007-06123	903	1000	1000
054007-06127	801	500	5000
054007-06129	905	500	5000

Electrical Products

3M™ Empty Scotchlok™ Terminal Boxes

The empty 3M™ Scotchlok™ terminal box is a red metal 17 slot or 24 slot box to hold your 3M™ Scotchlok™ Terminals.



Part Number	Dimensions	Slots	Each/Case
054007-11900	13.5" x 9.5" x 2"	17 Slot	6
054007-16161	18" x 12" x 3"	24 Slot	1

3M™ Scotchlok™ Electrical Connectors

For sure, quick easy splicing of solid or stranded wires. Packed 10 boxes per case.



Part Number	Type	Wire Range	Connectors/Box	Connectors/Case
054007-20041	"Y"	18-12	100	1000
054007-20058	"R"	16-10	100	1000
054007-42033	"B"	12-6	50	1000
054007-21346	"G"	14-8	100	1000

3M™ Scotchlok™ #558 Self-Stripping Electrical Tap Connectors

Connector is specially designed for small wire gauges. This U.L. listed connector permits fast and effective tap wire connections on 22-16 gauge standard or solid wire.



Part Number	Connectors/Box	Boxes/Case
Boxed		
054007-14861	100	10
Part Number	Connectors/Bag	Bags/Case
Bulk		
054007-14879	500	10

3M™ Scotchlok™ Fuse Holder

An inline fuse holder, designed to accommodate blade-type fuses. The fuse holder incorporates our patented self-stripping connector concept which simplifies installation by eliminating the need for supplemental connectors, thus reducing installation costs.



Part Number	Product Number	Holders/Box	Boxes/Case
Boxed			
054007-06171	972	25	10
Part Number	Product Number	Holders/Case	
Bulk			
054007-14879	972	1000	

3M™ Scotchlok™ Deluxe Terminal Assortment Kit

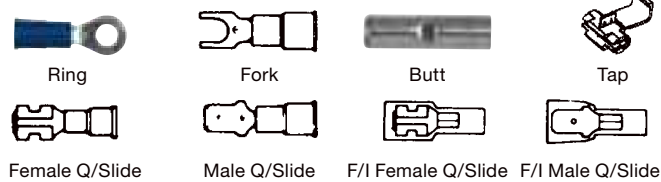

A 24 compartment red and white metal box imprinted with "3M Scotchlok Terminals." The compartments will contain 737 of the 24 most popular insulated terminals as follows:

Part Number	Type	Number of Pieces
054007-11914	Ring	10
054007-11915	Ring	10
054007-11921	Ring	30
054007-11922	Ring	50
054007-11923	Ring	30
054007-11924	Ring	20
054007-11932	Ring	20
054007-11934	Ring	20
054007-11935	Ring	70
054007-11920	Butt	50
054007-11928	Butt	100
054007-11939	Butt	50
054007-11926	Fork	10
054007-11927	Fork	20
054007-11918	Fork	10
054007-06126	Tap	27
054007-22997	Male Q/Slide	50
054007-22880	Female Q/Slide	100
054007-06152	F/I Male Q/Slide	10
054007-11960	F/I Female Q/Slide	10
054007-11822	Male Q/Slide	10
054007-11820	Female Q/Slide	10
054007-11919	Fork	10
054007-11913	Ring	10

Part Number	Each/Case
054007-06160	1

Electrical Products

3M™ Scotchlok™ Boxed Terminals

V-Vinyl; N-Nylon; N-G-Nylon-G

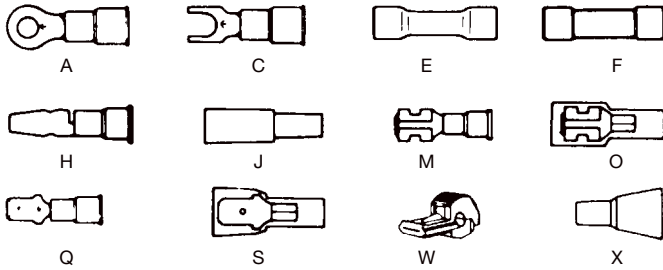

Part Number	Insul.	Wire Range	Stud Size	Each/ Box	Boxes/ Case	Ref. No.
T-Tap						
054007-06141	N	22-18	—	50	10	W
054007-06144	N	16-14	—	50	10	W
054007-06145	N	12-10	—	50	10	W
Quick Slide (Fully Insulated)						
054007-06152	N	16-14	—	100	5	S
054007-06153	N	12-10	—	50	10	S
054007-06154	N	22-18	—	100	5	S
054007-11959	N	22-18	—	100	5	O
054007-11960	N	16-14	—	100	5	O
054007-09991	N	12-10	—	50	10	O
Assortment						
054007-11000	—	—	—	1	5	—
Bullet Receptacle						
054007-11929	N	16-14	—	100	5	J
054007-11930	N	16-14	—	100	10	J
Quick Slide						
054007-11820	V	22-18	—	100	5	M
054007-11822	V	22-18	—	100	5	Q
054007-22880	V	16-14	—	100	5	M
054007-22997	V	16-14	—	100	5	Q
054007-09998	V	12-10	—	50	10	M
054007-23290	V	12-10	—	50	10	Q
RING						
054007-11913	V	22-18	6	100	5	A
054007-11914	V	22-18	10	100	5	A
054007-11915	V	22-18	1/4"	100	5	A
054007-11921	V	16-14	6	100	5	A
054007-11922	V	16-14	10	100	5	A
054007-11923	V	16-14	1/4"	100	5	A
054007-11924	V	16-14	3/8"	100	5	A
054007-11932	V	12-10	10	50	10	A
054007-11934	V	12-10	1/4"	50	10	A
054007-11935	V	12-10	3/8"	50	10	A
054007-11936	V	12-10	1/2"	50	10	A
054007-11940	V	8	3/8"	25	10	A
054007-11943	V	6	1/2"	20	10	A
054007-15625	V	8	1/4"	25	10	A
054007-15660	V	6	1/4"	20	10	A

3M™ Scotchlok™ Boxed Terminals (cont.)

Part Number	Insul.	Wire Range	Stud Size	Each/ Box	Boxes/ Case	Ref. No.
Block Spade						
054007-11918	V	22-18	6	100	5	C
054007-11919	V	22-18	10	100	5	C
054007-11926	V	16-14	6	100	5	C
054007-11927	V	16-14	10	100	5	C
054007-11937	V	12-10	6	50	5	C
054007-11938	V	12-10	10	50	10	C
Butt						
054007-11920	V	22-18	—	100	5	E
054007-11928	V	16-14	—	100	5	E
054007-11939	V	12-10	—	50	10	E
054007-15678	V	8	—	25	10	E
054007-22203	N-G	22-18	—	100	5	F
054007-22211	Butt	SN	22-18	100	5	F
054007-23128	N-G	16-14	—	100	5	F
054007-23136	Butt	SN	16-14	100	5	F
054007-24035	N-G	12-10	—	50	10	F
054007-24043	Butt	SN	12-10	50	10	F
Bullet (Grease Filled)						
054007-23094	V	16-14	—	100	5	H
Closed End						
054007-16732	N	22-18	—	100	10	X
054007-16734	N	18-10	—	50	10	X

3M™ Black All-Weather Resistant Cable Ties

These ties have been manufactured with a special weather resistant formula that make them ideal for outdoor applications; they resist deterioration from the sun's ultra-violet light and as a result last far longer than natural colored nylon ties and many other black colored cable ties.



Part Number	Style	Length	Ties/Bag	Ties/Case
Bag				
054007-06200	Miniature	3-3/4"	100	1,000
054007-06201	Intermediate	5-7/8"	100	1,000
054007-06202	Standard	7-5/16"	100	1,000
054007-06203	Standard	12"	100	1,000
054007-06204	Standard	15"	100	500
054007-06205	Mounting	8-5/16"	100	1,000
054007-06207	Heavy Duty	15"	100	500
Bulk				
054007-06270	Miniature	3-3/4"	1,000	10,000
054007-06271	Intermediate	5-7/8"	1,000	10,000
054007-06272	Standard	7-5/16"	1,000	10,000
054007-06273	Standard	12"	1,000	10,000
054007-06274	Standard	15"	500	25,000
054007-06275	Mounting	8-5/16"	1,000	10,000
054007-06277	Heavy Duty	15"	500	2,500

Electrical Products

3M™ Cable Ties

These ties resist flame, solvent, alkalies and grease. Available in lengths 3-3/4" through 15-5/8", in miniature, intermediate, standard and mounting type configurations. One piece nylon construction, single pawl with double-locking teeth holds without slipping.

Part Number	Style	Length	Ties/	
			Bag	Case
Bag				
054007- 06224	Miniature	3-3/4"	100	1,000
054007- 06225	Intermediate	5-7/8"	100	1,000
054007- 06226	Standard	7-5/16"	100	1,000
054007- 06227	Standard	12"	100	1,000
054007- 06228	Standard	15"	100	500
054007- 06232	Mounting #10 Stud	8-5/16"	100	1,000
054007- 06234	Mounting #10 Stud	15-7/16"	50	500
054007- 06243	Heavy Duty Mounting	15-5/8"	100	1,000
Bulk				
054007- 06248	Miniature	3-3/4"	1,000	10,000
054007- 06249	Intermediate	5-7/8"	1,000	10,000
054007- 06250	Standard	7-5/16"	1,000	10,000
054007- 06251	Standard	12"	1,000	10,000
054007- 06252	Standard	15"	500	25,000
054007- 06256	Mounting #10 Stud	8-5/16"	1,000	10,000
054007- 06258	Mounting #10 Stud	15-7/16"	500	2,500
054007- 06264	Heavy Duty	15"	500	2,500
054007- 06267	Heavy Duty Mounting	15-5/8"	500	2,500

3M™ Black All-Weather Resistant Cable Ties – Heavy Duty

This heavy duty black cable tie is long lasting. Its special weather resistant formula effectively resists the deterioration from the sun's ultraviolet (U.V.) rays.



Part Number	Length	Ties/Bag	Bags/Case
054007- 06208	32"	50	10

3M™ Black All-Weather Resistant Cable Ties – Extra Heavy Duty

This extra heavy duty cable tie is designed for the most demanding situations. Its 34" length and 175 lbs./inch tensile strength insures long lasting cable retention. This black tie resists weathering and the effects of ultraviolet (U.V.) light.



Part Number	Length	Ties/Bag	Bags/Case
054007- 06209	34"	50	10

3M™ Cable Tie Assortment Pack

Use 3M™ Cable Ties with confidence when you secure wire bundles, harnesses and components. The flexible design allows you to slip ties easily under and around wires, cables and harnesses. The convenient assortment pack provides the customer with 100 ties of the most popular lengths.



Part Number	Ties/Bag	Bags/Case
054007- 06220	100	10

Description	Length	Quantity	Type
Miniature	4"	15 Ea.	Natural
Miniature	4"	10 Ea.	Weather Resistant Black
Intermediate	5"	15 Ea.	Natural
Intermediate	5"	10 Ea.	Weather Resistant Black
Standard	7.5"	15 Ea.	Natural
Standard	7.5"	10 Ea.	Weather Resistant Black
Standard	11"	15 Ea.	Natural
Standard	11"	10 Ea.	Weather Resistant Black

3M™ 100 Hook-and-Loop Fastener

Incorporate flexibility, a thin profile, and superior strength for a unique cable bundling, harnessing and wire fastening system. 3M's 100 fasteners secure quickly and easily, remain locked without slipping and can be re-used for maximum efficiency. These fasteners are ideal for use on cable and wire assemblies, fiber optic installations or bundling and wrapping of most items.

Part Number	Size	Description	Rolls/Case
051128- 53593	3/8" x 18 yds.	Uncut Roll	36
051128- 53594	1/2" x 18 yds.	Uncut Roll	36
051128- 53595	1" x 18 yds.	Uncut Roll	36
051128- 53596	3/8" – 6" perforations	100 Count Roll	36
051128- 53597	1/2" – 6" perforations	100 Count Roll	36
051128- 53598	1" – 6" perforations	100 Count Roll	36
051128- 53599	3/8" – 8" perforations	75 Count Roll	36
051128- 53600	1/2" – 8" perforations	75 Count Roll	36
051128- 53601	1" – 8" perforations	75 Count Roll	36

Part Number	Description	Dispensers/Case
051128- 53604	Hand Held Dispenser	12

Retail Packaged Electrical Products

3M™ Scotchlok™ Electrical Connectors Carded

Constructed of a "Live Spring" for strong, reliable wire contact which is enclosed in a crush-proof steel inner shell, then covered by a flexible PVC plastic that won't crack. Packed 10 cards per box; 5 boxes per case.



Part Number	Type	Wire Gauge	Connectors/Card
054007-06110	"V"	18-12	5
054007-06111	"R"	16-10	4
054007-06112	"G"	14-8	3

Scotch® Super 33 Plus Vinyl Plastic Electrical Tape

An extremely conformable 7-mil high-performance tape that resists water, oils, acids and weather. Has insulation properties of both rubber and friction tapes. U.L. approved.



Part Number	Size	Rolls/Case
054007-10414	3/4" x 450"	24
054007-10455	3/4" x 350"	24

Scotch® Cold Weather Electrical Tape

An economically priced tape. 7-mil thickness, tough and stretchy. Each roll cellophane wrapped. U.L. listed.



Part Number	Size	Rolls/Case
054007-16736	3/4" x 300"	24

3M™ Scotchlok™ TH-440 Crimping Tool

A compact, high-quality tool designed to perform the six most common electrical wiring functions. Made of .125 inch heat-treated carbon steel for maximum durability, it handles a variety of terminal and connector styles, insulated and non-insulated, over a range of 22-10 AWG.



Part Number	Tools/Case
054007-60825	10

3M™ Scotchlok™ TH-450 Scissors Style Crimping Tool

3M's most versatile and heavy-duty tool. Made of high-strength-heat-treated carbon steel, the TH-450 is lightweight without sacrificing strength. It handles a variety of terminal and conductor styles, including flags, closed-end connectors, crimp sleeves and standard parts, both insulated and non-insulated. With a range of 26-6 AWG wire size, connections are U.L. approved when the crimping process is completed and the tool releases.



Part Number	Wire Range	Rolls/Case
054007-13760	26-6	10

3M™ ScotchPad™ Hang Tabs

3M™ ScotchPad™ Hang Tabs

Made of clear, sturdy plastic and pressure-sensitive adhesive that will stick to most surfaces. They come on a convenient, self-sticking pad for easy manual application and portability. They are handy for hanging shrink-wrap packages as well as for in-store repair of damaged packaging, such as torn punches in chipboard header cards and plastic bags.



Part Number	Product Number	Description	Hang Tabs/Pad	Pads/Case
021200- 62013	1075	2" x 2" Delta Hole	10	500
021200- 62014	1076	2" x 2" Round Hole	10	500
021200- 62225	1074	1" x 2" Mini	10	1,000

Post-it® Quality Flag

Post-it® Quality Flag

These flags offer an easy and quick method of identifying areas of concern on many work surfaces. Attention-getting colored flag (yellow with black lettering "QUALITY") that adheres to any surface without contamination. Dispenser holds the flags and offers an automatic pop-up feature. Dispenser size is 1" x 1.7".



Part Number	Flags/Dispenser	Dispensers/Case
021200- 71450	75	100

Laminating Systems

3M™ Laminating System LS950

A heat-free way to finish documents up to 8-1/2" wide in one system! Laminate, for instant document protection; apply adhesive, for permanent self-stick labels and signs; or do both at once to create laminated, permanent labels in seconds.

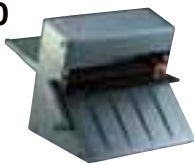

Part Number	Product Number	Dispensers/Case
021200-59151	LS950	1

3M™ Dual Laminate Refill Cartridge DL951

For use with the 3M™ Laminating System LS950. Front and back side lamination. Great for presentations, 3-ring binder sheets, schedules and more. 2.5 mils thick, 8-1/2" wide x 100' long, approximately 100 8-1/2" x 11" applications.



Part Number	Product Number	Size	Each/Case
021200-59152	DL951	100' x 8-1/2"	1

Point of Sale Displays

3M™ Marine Adhesive/Sealant 5200 Floor Display

This display is for retailers and yards with 5200 customers. Floor display consists of 108 cartridges of 3M™ Marine Adhesive/Sealant 5200 (PN06500). The display ships complete; take "shroud" off and it is ready to sell. Top row already cut for display. Sell through each tray, remove or refill.

Part Number	Displays/Case
051135-06499	1

Part Number Index

Part Number	Page	Part Number	Page	Part Number	Page	Part Number	Page
021200-00002	72	051131-00381	2	051131-01053	29	051144-01468	6
021200-00006	81	051131-00382	13	051131-01055	29	051144-01469	6
021200-00007	81	051131-00389	13	051131-01068	29	051144-01470	6
021200-00008	81	051131-00390	13	051131-01069	29	051144-01471	6
021200-00009	81	051131-00391	13	051131-01070	29	051144-01472	6
021200-00010	81	051131-00392	13	051131-01071	29	051144-01473	6
021200-00011	81	051131-00393	13	051131-01202	4	051131-01484	4
021200-00012	81	051131-00394	13	051131-01203	4	051131-01485	4
021200-00013	81	051115-00408	22, 34	051131-01204	4	051131-01487	4
021200-00014	81	051115-00409	22, 34	051131-01205	4	051131-01488	4
021200-00015	81	051131-00429	13	051131-01206	4	051131-01489	4
021200-00016	81	051131-00430	13	051131-01208	4	051131-01490	4
021200-00017	81	051131-00431	13	051131-01214	4	051131-01491	4
021200-00018	81	051131-00432	13	051131-01215	4	051131-01492	4
021200-00019	81	051131-00433	13	051131-01216	4	051131-01493	4
021200-00020	81	051131-00434	13	051131-01318	3	051144-01501	3
021200-00021	81	051131-00435	13	051131-01319	3	051144-01506	3
021200-00213	69	051131-00436	13	051131-01320	3	051131-01545	3
051131-00298	2	051131-00437	13	051131-01321	3	051131-01546	3
051131-00299	2	051115-00444	77	051131-01396	38	051131-01547	3
051131-00301	2	051115-00445	77	051131-01397	38	051131-01548	3
051131-00302	2	051131-00484	13	051131-01398	38	051131-01549	3
051131-00303	2	051131-00485	13	051131-01406	38	051131-01550	3
051131-00304	2	051131-00486	13	051131-01407	38	051131-01551	3
051131-00305	2	051131-00487	13	051131-01408	38	051131-01552	3
051131-00306	2	051131-00488	13	051131-01417	4	051131-01556	3
051131-00307	2	051131-00489	13	051131-01418	4	051131-01561	26
051131-00308	2	051131-00496	13	051131-01419	4	051131-01566	26
051131-00309	2	051131-00497	13	051144-01420	4	051131-01569	26
051131-00322	2	051131-00498	13	051144-01421	4	051131-01619	25
051131-00323	2	051131-00499	13	051144-01422	4	051131-01620	25
051131-00324	2	051131-00500	13	051144-01423	4	051131-01621	25
051131-00325	2	051131-00501	13	051144-01424	4	051131-01622	25
051131-00326	2	051115-00630	22	051144-01425	4	051131-01623	25
051131-00327	2	051115-00631	22	051144-01426	4	051131-01624	25
051131-00328	2	040811-00645	46	051144-01427	4	051131-01625	25
051131-00329	2	040811-00670	46	051144-01428	4	051131-01626	25
051131-00330	2	040811-00751	46	051131-01432	4	051131-01627	25
051131-00331	2	040811-00752	46	051131-01433	4	051131-01628	25
051131-00332	2	051131-00907	10	051131-01434	4	051131-01633	25
051131-00333	2	051131-00908	10	051144-01435	4	051131-01634	25
051131-00336	2	051131-00909	10	051144-01436	4	051131-01635	25
051131-00337	2	051131-00910	10	051144-01437	4	051131-01636	25
051131-00338	2	051131-00911	10	051144-01438	4	051131-01637	25
051131-00339	2	054007-00917	138	051144-01439	4	051131-01638	25
051131-00340	2	051131-00950	10	051144-01440	4	051131-01639	25
051131-00341	2	051131-00951	10	051144-01441	4	051131-01640	25
051131-00350	13	051131-00952	10	051144-01442	4	051131-01641	25
051131-00351	13	051131-00953	10	051144-01443	4	051131-01642	25
051131-00367	2	051131-00954	10	051144-01450	6	051131-01643	25
051131-00368	2	051131-00955	10	051144-01451	6	051131-01652	10
051131-00371	2	051131-00968	10	051144-01453	6	051131-01660	26
051131-00372	2	051131-00969	10	051144-01454	6	051131-01661	26
051131-00373	2	051131-00970	10	051144-01455	6	051131-01665	26
051131-00374	2	051131-00971	10	051144-01456	6	051131-01667	26
051131-00377	2	021200-01008	72	051144-01458	6	051131-01668	26
051131-00378	2	021200-01009	72	051144-01465	6	051144-01722	37
051131-00379	2	021200-01010	72	051144-01466	6	051144-01725	37
051131-00380	2	051131-01050	29	051144-01467	6	051144-01727	37

Part Number Index

Part Number	Page	Part Number	Page	Part Number	Page	Part Number	Page
051131-01728	8	051131-01807	28	051131-01860	16	051131-01989	40
051131-01729	8	051131-01808	28	051131-01861	16	051131-01990	40
051131-01730	8	051131-01809	28	051131-01862	16	051131-01991	40
051131-01733	8	051131-01810	28	051131-01863	16	051131-01994	40
051131-01734	8	051131-01811	28	051131-01864	16	051144-02000	19
051131-01735	8	051131-01812	28	051131-01865	16	051144-02001	19
051144-01738	37	051131-01813	28	051131-01866	16	051144-02002	19
051144-01739	37	051131-01814	28	051131-01867	16	051144-02003	19
051144-01740	37	051131-01815	28	051131-01868	16	051144-02004	19
051131-01743	8	051131-01816	28	051131-01869	16	051144-02005	19
051131-01744	8	051131-01817	28	051131-01870	16	051144-02006	19
051131-01745	8	051131-01818	28	051131-01871	16	051144-02007	19
021200-01748	69	051144-01818	37	051131-01872	16	051144-02014	19
051131-01756	8	051131-01819	28	051131-01873	16	051144-02015	19
051131-01757	8	051144-01819	37	051131-01874	16	051144-02016	19
051131-01759	8	051131-01820	28	051131-01875	16	051144-02017	19
051131-01760	8	051144-01820	37	051131-01876	16	051144-02018	19
051144-01760	37	051131-01821	28	051131-01877	16	051131-02019	19
051131-01761	8	051131-01822	28	051131-01878	16	051144-02019	19
051144-01761	37	051131-01823	28	051131-01879	16	051131-02020	19
051131-01762	8	051131-01824	28	051131-01880	16	051144-02021	19
051131-01763	8	051131-01825	28	051131-01881	16	051131-02022	19
051131-01764	8	051131-01826	28	051131-01882	16	051131-02023	19
051131-01765	8	051131-01827	28	051131-01883	16	051131-02032	19
051131-01766	8	051131-01828	28	051131-01884	16	051131-02033	19
051131-01767	8	051131-01829	28	051131-01885	16	051131-02034	19
051131-01768	8	051131-01830	28	051131-01886	9	051131-02035	19
051131-01769	16	051131-01831	28	051131-01887	9	051131-02036	19
051131-01770	8	051131-01832	28	051131-01888	9	051131-02037	19
051131-01773	8	051131-01833	28	051131-01889	9	051131-02038	19
051131-01774	8	051144-01833	37	051131-01896	9	051131-02039	19
051131-01775	8	051131-01834	28	051131-01897	9	051131-02040	19
051131-01776	8	051144-01834	37	051131-01898	9	051131-02041	19
051131-01777	8	051131-01835	28	051131-01899	9	051131-02042	19
051131-01778	8	051144-01835	37	051131-01900	9	051131-02043	19
051131-01779	8	051131-01836	28	051131-01901	9	051131-02044	19
051131-01780	8	051131-01837	28	051131-01902	9	051131-02045	19
051131-01781	8	051131-01838	8	051131-01903	9	051131-02075	10, 64
051131-01782	8	051131-01839	8	051131-01904	9	051131-02077	10, 64
051131-01783	8	051131-01840	8	051131-01905	9	051131-02230	14
051131-01784	8	051131-01841	8	051131-01906	9	051144-02231	14
051131-01785	8	051131-01842	8	051131-01913	36	051144-02232	14
051131-01786	8	051131-01843	8	051131-01914	36	051131-02500	23
051131-01787	8	051131-01844	28	051131-01915	36	051115-02501	77
051131-01791	16	051131-01845	28	051131-01921	36	051115-02502	77
051131-01793	16	051131-01846	28	051131-01922	36	051131-02508	96
051131-01794	16	051131-01847	28	051144-01923	36	051131-02510	23
051131-01795	28	051131-01848	28	051131-01927	36	051131-02513	20
051131-01796	28	051131-01849	28	051131-01928	36	051131-02514	23
051131-01797	28	051131-01850	28	051144-01929	36	051131-02536	21
051131-01798	28	051131-01851	28	051131-01962	9	051131-02537	21
051131-01799	28	051131-01852	28	051131-01963	9	051131-02538	21
051131-01800	28	051131-01853	28	051131-01964	9	051131-02539	21
051131-01801	28	051131-01854	28	051131-01965	9	051131-02540	21
051131-01802	28	051131-01855	28	051131-01966	9	051131-02541	21
051131-01803	28	051131-01856	28	051131-01967	9	051131-02542	21
051131-01804	28	051131-01857	28	051131-01968	9	051131-02543	21
051131-01805	28	051131-01858	28	051131-01987	40	051131-02544	21
051131-01806	28	051131-01859	28	051131-01988	40	051131-02545	21

Part Number Index

Part Number	Page	Part Number	Page	Part Number	Page	Part Number	Page
051131-02546	21	021200-03320	86	021200-05421	79	051131-05740	17
051131-02547	21	021200-03337	84	021200-05423	75	051131-05741	17
051131-02548	21	021200-03394	86	051144-05440	15	051131-05742	17
051131-02549	21	051131-03455	133	051144-05441	15	051131-05744	17
051131-02551	21	051131-03456	133	051144-05442	15	051131-05748	17
051131-02552	21	051131-03458	133	051144-05444	15	051131-05755	11
051131-02553	21	051131-03459	133	051144-05448	15	051131-05756	11
051131-02554	21	051131-03460	133	051144-05450	7	051131-05766	56
051131-02567	21	051131-03461	133	051144-05452	15	051131-05768	11
051131-02568	21	051131-03462	133	051144-05517	20	051131-05769	11
051131-02569	21	051131-03463	133	051144-05518	20	051131-05771	11, 30
051131-02586	14	051131-03464	133	051144-05519	21	051131-05773	11, 30
051131-02589	14	040811-04305	46	051131-05520	21	051131-05774	11, 30
051131-02590	14	040811-04306	46	051131-05526	20	051131-05775	11
051131-02591	14	021200-04319	76	051144-05530	15	051131-05776	11, 47
051131-02593	14	021200-04365	74	051144-05539	38, 51	051131-05779	11
051131-02594	14	021200-04597	76	051144-05540	38, 51	051131-05781	11
051131-02595	14	021200-04698	75	051131-05541	38	051131-05782	11
051131-02597	14	021200-04699	75	051131-05545	6	051131-05791	12
051131-02598	14	021200-04700	75	051131-05546	6	051131-05792	12
051131-02599	14	021200-04701	75	051131-05555	6	051131-05800	54
051131-02600	22	021200-04850	84	051131-05556	6	051131-05801	54
051131-02601	22	021200-04968	75	051131-05568	7	051131-05804	54
051131-02602	22	051144-05002	22	051144-05575	6	051131-05805	54
051131-02604	22	051144-05003	22	051144-05576	6	051131-05814	54
051131-02606	22	051144-05004	22	051144-05579	7	051131-05815	54
051131-02689	14	051144-05005	22	051131-05581	7	051131-05816	54
051131-02691	14	051144-05006	22	051131-05582	7	051131-05821	55
051131-02693	14	051144-05007	22	051144-05585	7	051131-05830	56
051131-02694	14	051144-05008	22	051144-05586	7	051131-05833	56
051131-02695	14	051144-05009	22	051131-05589	7	051131-05834	56
051131-02696	14	051144-05022	22	051131-05591	7	051131-05836	56
051131-02697	14	051144-05024	22	021200-05617	74	051131-05837	56
051131-02698	14	051144-05025	22	021200-05618	74	051131-05838	56
021200-02828	76	051144-05026	22	021200-05619	74	051131-05842	56
021200-02829	76	051144-05027	22	021200-05620	74	051131-05844	56
021200-02830	76	051144-05028	22	051144-05620	39	051131-05856	30
021200-02991	74	051144-05029	22	021200-05621	74	051131-05860	23
021200-02992	74	051144-05030	22	051144-05621	39	051131-05861	23
021200-02993	74	051144-05042	22	051144-05622	39	051131-05868	54
021200-02994	74	051144-05044	22	051131-05645	27	051131-05870	54
051131-03050	32	051144-05045	22	051131-05646	27	051131-05871	54
051131-03051	32	051144-05046	22	051131-05655	27	051131-05876	30
051131-03055	32	051144-05047	22	051131-05656	27	051131-05885	30
051131-03057	32	051144-05048	22	048011-05680	48	051131-05912	92
021200-03119	75	051144-05049	22	051131-05682	27	051131-05916	92
021200-03120	75	051144-05050	22	051131-05700	65	051131-05919	92
021200-03121	75	051135-05203	95	051131-05701	66	051131-05928	58
021200-03135	79	051135-05205	95	051131-05703	65	051131-05929	58
021200-03136	79	021200-05206	95	051131-05704	65	051131-05954	58, 62
051131-03171	33	051135-05206	95	051131-05705	65, 66	051131-05955	58, 62
051131-03172	33	051135-05220	95	051144-05710	63, 67	051144-05960	55
021200-03174	76	051135-05260	95	051131-05713	65, 66	051131-05962	55
021200-03175	76	051131-05270	64	051131-05717	63, 67	051144-05964	55
051144-03192	31	051131-05276	64	051131-05718	63, 67	051144-05966	55
021200-03291	86	051135-05280	95	051131-05719	65	051131-05975	125
021200-03314	86	021200-05418	79	051131-05725	65, 66	051131-06016	63, 67
021200-03318	86	021200-05419	79	051131-05726	65, 66	051131-06017	63, 67
021200-03319	86	021200-05420	79	051131-05734	65, 66	051131-06018	63, 67

Part Number Index

Part Number	Page	Part Number	Page	Part Number	Page	Part Number	Page
051131-06025	62	051135-06214	2	051131-06446	85	051131-06796	90
051131-06026	62	051135-06216	2	021200-06452	85	051131-06802	89
051131-06027	62	051135-06217	2	021200-06455	85	051131-06804	90
051131-06044	62	051135-06218	2	021200-06458	85	051115-06817	76
051131-06045	62	051135-06219	2	051131-06463	103	051115-06818	76
051131-06046	62	051135-06220	2	051131-06480	102	051115-06819	76
051131-06060	64	054007-06220	142	051131-06483	103	051115-06820	76
051131-06061	64	051135-06221	2	051131-06484	103	051131-06845	89
051131-06062	64	051135-06222	2	051131-06491	84	051131-06848	89
051131-06063	64	051135-06223	2	051131-06492	84	021200-06864	91
051131-06064	64	054007-06224	142	051131-06493	84	021200-06865	91
051131-06065	64	054007-06225	142	051135-06499	145	021200-06866	91
051131-06066	64	054007-06226	142	051135-06500	95	051131-06869	92
051131-06067	64	054007-06227	142	051135-06501	95	021200-06871	92
051131-06070	64	054007-06228	142	051135-06502	95	051131-06893	82
054007-06106	138	054007-06232	142	021200-06503	87	051131-06894	82
054007-06108	138	054007-06234	142	051135-06504	95	051131-06895	82
054007-06110	143	054007-06243	142	021200-06506	87	051131-06896	82
054007-06111	143	054007-06248	142	051131-06508	88	051131-06897	82
054007-06112	143	054007-06249	142	021200-06509	87	051131-06898	82
054007-06118	139	054007-06250	142	051135-06510	95	051131-06904	88
054007-06119	139	054007-06251	142	021200-06512	87	021200-06910	82
054007-06120	139	054007-06252	142	021200-06518	87	021200-06923	84
054007-06122	139	054007-06256	142	051131-06520	95	021200-06925	83
054007-06123	139	054007-06258	142	021200-06524	87	021200-06927	84
054007-06126	139, 140	054007-06264	142	021200-06536	87	051131-06937	82
054007-06127	139	054007-06267	142	051131-06537	88	051131-06938	82
054007-06128	139	054007-06270	141	051131-06538	88	051131-06939	82
054007-06129	139	054007-06271	141	051131-06539	88	021200-06944	84
054007-06130	135	054007-06272	141	051135-06539	102	021200-06947	83
054007-06132	135	054007-06273	141	051131-06540	88	021200-06953	82
054007-06133	135	054007-06274	141	051131-06545	77	051131-06954	83
054007-06134	139	054007-06275	141	051131-06547	77	051115-06964	22
054007-06135	139	054007-06277	141	051131-06548	77	051115-06965	22
054007-06141	141	021200-06300	75	051135-06560	95	051115-06966	22
054007-06143	135	021200-06301	75	051135-06564	95	051115-06967	22
054007-06144	141	021200-06302	75	051135-06580	95	051115-06968	22
054007-06145	141	021200-06303	75	051135-06586	95	051131-06975	78
054007-06147	138	021200-06305	75	051131-06639	83	051131-06997	84
054007-06149	138	021200-06306	75	051131-06640	83	051115-07107	22
054007-06152	140, 141	021200-06307	75	051131-06642	83	051115-07108	22
054007-06153	141	021200-06308	75	051131-06696	89	051115-07109	22
054007-06154	141	021200-06330	74	051131-06697	89	051131-07410	50
054007-06160	140	021200-06332	74	051131-06706	87	051144-07413	31
051131-06165	135	021200-06334	74	051131-06712	87	051144-07414	31
054007-06171	140	021200-06336	74	051131-06718	87	051144-07415	31
054007-06192	85	021200-06338	74	051131-06727	90	051131-07439	45
054007-06195	85	021200-06340	74	051131-06728	90	051131-07441	45
054007-06196	85	021200-06341	74	051131-06732	87	051131-07442	45
054007-06200	141	021200-06343	74	051131-06736	87	051131-07443	50
054007-06201	141	021200-06344	74	051131-06738	87	051131-07445	45
054007-06202	141	051131-06396	85	051131-06780	90	051131-07447	45
054007-06203	141	051131-06404	75	051131-06781	91	051131-07448	45
054007-06204	141	021200-06405	75	051131-06783	91	040811-07450	46
054007-06205	141	051131-06408	75	051131-06784	91	040811-07451	46
054007-06207	141	051131-06409	75	051131-06787	91	051131-07453	46
054007-06208	142	051131-06439	85	051131-06788	90	051131-07455	46
054007-06209	142	051131-06440	85	051131-06794	90	051131-07456	46
051135-06213	2	051131-06443	85	051131-06795	90	051131-07457	46

Part Number Index

Part Number	Page	Part Number	Page	Part Number	Page	Part Number	Page
051131-07466	50	048011-08251	45	051144-09085	31	048011-09457	132
051131-07467	47	048011-08293	45	051144-09086	31	054007-09458	136
051131-07468	47	051135-08398	96	051144-09087	31	054007-09482	138
051131-07480	49	048011-08554	132	051144-09088	31	054007-09483	138
051131-07481	49	051135-08578	97	051131-09089	58	054007-09484	138
051131-07482	49	051135-08672	97	051131-09091	17	054007-09485	138
051131-07483	49	051135-08796	104	051131-09092	17	054007-09486	138
051131-07485	49	051135-08875	104	051144-09140	32	054007-09487	138
051131-07486	49	051135-08876	104	051144-09141	32	048011-09489	46
048011-07492	47	051135-08877	104	051144-09145	32	054007-09656	135
051131-07493	47	051135-08878	104	051144-09146	32	054007-09915	138
048011-07494	47	051135-08888	69	051144-09147	32	054007-09916	138
051131-07498	51	051135-08898	104	051144-09170	31	054007-09931	138
051131-07499	51	051135-08945	104	051144-09171	31	054007-09991	141
051131-07500	50, 51	051135-08946	104	051144-09172	31	054007-09998	141
051131-07501	51	051135-08984	70, 99	051144-09173	32	054007-10075	135
051131-07502	51	051135-08986	70, 99	051144-09176	31	051111-10101	105
051131-07504	46	051135-08987	70, 99	051144-09205	32	051111-10103	105
051131-07505	46	051135-08991	96	051144-09206	32	051111-10111	105
051131-07506	46	051135-08992	96	051144-09207	32	051111-10112	105
051131-07507	46	051135-08993	96	051144-09208	32	051111-10113	105
051131-07508	46	051144-09001	31	054007-09230	139	051111-10115	72
051131-07509	46	051144-09002	31	054007-09231	139	051111-10116	72
051131-07511	49	051144-09003	31	021200-09292	31	051111-10118	72
051131-07513	49	051131-09004	58, 62	051144-09305	32	051111-10120	72
051131-07514	49	051131-09005	58	051144-09307	32	054007-10216	135
051131-07515	49	051144-09005	31	051144-09308	32	054007-10307	135
051131-07516	49	051131-09006	58	051144-09312	32	054007-10414	143
051131-07517	51	051131-09007	58	051144-09314	32	054007-10455	143
051131-07521	46	051131-09009	59, 68	051144-09315	32	051144-10695	19
051131-07522	46	051131-09010	59, 68	054007-09368	136	051144-10697	19
051115-07921	18	051131-09011	59, 68	054007-09369	136	051144-10699	19
051115-07922	18	051131-09019	58	054007-09370	136	054007-10810	135
051115-07923	18	051131-09020	58	054007-09371	136	054007-10828	135
051115-07924	18	051131-09023	60	054007-09372	136	054007-10836	135
051115-07934	18	051144-09025	32	054007-09373	136	054007-10851	135
051115-07935	18	051131-09026	60	054007-09374	136	051111-10954	33
051115-07937	18	051144-09026	32	054007-09375	136	051111-10955	33
051115-07938	18	051131-09027	60	054007-09376	136	054007-11000	141
051131-07950	134	051144-09027	32	054007-09377	136	054007-11008	135
051131-07951	134	051131-09029	59, 68	054007-09378	136	1100-DP	123
051131-07952	134	051131-09030	60	054007-09404	136	1100-R	123
051115-07997	89	051144-09030	32	051144-09410	32	051144-11063	7
051135-08001	97	051144-09031	32	051144-09411	33	1120	123
051135-08011	97	051131-09033	60	051144-09413	33	1120-DP	123
051135-08017	96	051131-09034	59, 68	051144-09414	33	1120-R	123
051135-08019	96	051131-09035	59, 68	051144-09415	32	054007-11222	135
051135-08027	96	051131-09038	58, 68	051144-09416	32	051144-11287	6
051135-08029	96	051131-09047	59, 68	054007-09423	136	051144-11289	6
051135-08031	97	051131-09048	58, 62	054007-09424	136	1130	123
051135-08051	97	054007-09056	138	054007-09425	136	051111-11515	33
051131-08074	98	051131-09060	59, 68	054007-09426	136	051111-11516	33
051131-08088	98	051131-09061	60	054007-09427	136	051111-11517	33
051131-08090	98	051131-09062	60	054007-09428	136	054007-11820	140, 141
051135-08101	97	051131-09063	59, 68	054007-09429	136	054007-11822	140, 141
051135-08107	97	051131-09065	60	054007-09430	136	051144-11824	37
048011-08148	132	051131-09067	59, 68	054007-09431	136	054007-11900	140
051135-08155	97	051131-09082	17	048011-09450	47, 48	054007-11913	140, 141
051135-08191	97	051144-09084	31	048011-09451	47	054007-11914	140, 141

Part Number Index

Part Number	Page	Part Number	Page	Part Number	Page	Part Number	Page
054007-11915	140, 141	051135-14010	2	1751	122	051115-19638	29
054007-11918	140, 141	051135-14011	2	1752	122	051115-19639	29
054007-11919	140, 141	048011-14111	48	048011-17580	129	051115-19640	29
054007-11920	140, 141	051144-14175	21	1760	122	051115-19641	29
054007-11921	140, 141	051144-14177	21	048011-17635	131	051115-19642	29
054007-11922	140, 141	051144-14179	21	048011-17636	131	051115-19643	29
054007-11923	140, 141	051144-14181	21	051115-17688	75	051115-19644	29
054007-11924	140, 141	051144-14183	21	048011-17780	129	051115-19645	29
054007-11926	140, 141	051144-14186	21	048011-17788	129	051115-19646	29
054007-11927	140, 141	051144-14188	21	048011-17790	129	051115-19647	16
054007-11928	140, 141	051144-14190	21	021200-18088	86	051115-19648	16
054007-11929	141	1427	123	021200-18092	86	051115-19649	16
054007-11930	141	051144-14270	39	048011-18694	52	051115-19650	16
054007-11932	140, 141	1440	123	048011-18695	52	051115-19651	16
054007-11934	140, 141	1450	121	048011-18696	52	051115-19652	16
054007-11935	140, 141	021200-14557	85	048011-18697	52	051115-19653	16
054007-11936	141	021200-14558	85	048011-18698	51	048011-19927	70
054007-11937	141	051144-14634	38	048011-18706	51	021200-19936	100
054007-11938	141	051144-14661	38	048011-18710	51	054007-20041	140
054007-11939	140, 141	051144-14736	63, 67	048011-18730	51	051144-20052	37
054007-11940	141	051144-14738	11	048011-18732	51	051144-20053	37
054007-11943	141	021200-14765	83	048011-18733	51	051144-20054	37
054007-11959	141	021200-14766	83	048011-18734	51	054007-20058	140
054007-11960	140, 141	054007-14853	138	048011-18736	51	021200-20227	97
1260	123	054007-14861	140	048011-18737	51	021200-20272	99
1270	123	054007-14879	140	021200-18813	83	021200-20274	99
1310	123	054007-14879	140	1901	121	048011-20529	131
1311	123	048011-15027	45	1902	121	048011-20530	131
051144-13325	39	051144-15287	18	1903	121	048011-20531	131
051144-13627	47	051144-15288	18	1904	121	048011-20536	131
048011-13702	68	051144-15289	18	1905	121	048011-20540	131
048011-13722	131	051144-15290	18	1906	121	048011-20544	131
048011-13723	131	051144-15299	18	1911	121	048011-20545	131
054007-13760	136, 143	051144-15300	18	1912	121	048011-20546	131
051144-13884	37	051144-15301	18	1914	121	048011-20550	131
051144-13885	37	051144-15302	18	1915	121	048011-20551	131
051144-13886	37	054007-15625	141	1916	121	048011-20555	131
051144-13888	37	054007-15660	141	048011-19202	70	048011-20559	131
051144-13889	37	054007-15678	141	048011-19211	70	048011-20560	131
051135-13935	9	021200-16028	75	048011-19344	68	048011-20561	131
051135-13936	9	048011-16107	131	048011-19349	68	048011-20565	131
051135-13937	9	048011-16108	131	1950	121	048011-20566	131
051135-13938	9	1611	122	051115-19621	9	048011-20570	131
051135-13939	9	16-1101-40	109	051115-19622	9	048011-20583	131
051135-13940	9	054007-16161	140	051115-19623	9	048011-20584	131
051135-13941	9	1631	121	051115-19624	9	048011-20585	131
051135-13942	9	054007-16720	135	051115-19625	9	048011-20589	131
051135-13943	9	054007-16732	141	051115-19626	9	048011-20590	131
051135-13944	9	054007-16734	141	051115-19627	9	048011-20594	131
048011-14002	70	054007-16736	143	051115-19628	9	048011-20642	131
051135-14002	2	048011-16861	68	051115-19629	29	048011-20688	45
048011-14003	69	1701	122	051115-19630	29	2071	108, 115
051135-14003	2	1702	122	051115-19631	29	2091	108, 110, 115
051135-14004	2	021200-17063	83	051115-19632	29	2097	108, 110, 115
051135-14005	2	1722	122	051115-19633	29	021200-21180	99
051135-14006	2	1723	122	051115-19634	29	021200-21181	99
051135-14007	2	1740	122	051115-19635	29	021200-21182	99
051135-14008	2	1743	122	051115-19636	29	021200-21183	99
051135-14009	2	1750	122	051115-19637	29	021200-21210	98

Part Number Index

Part Number	Page	Part Number	Page	Part Number	Page	Part Number	Page
054007-21296	135	048011-23651	63, 67, 72	048011-26436	129	048011-29212	48
054007-21346	140	048011-23652	63, 67, 72	048011-26437	129	048011-29213	48
051144-21783	5	048011-23748	131	048011-26439	129	048011-29214	48
051144-21784	5	048011-23749	131	048011-26440	129	048011-29217	48
051144-21785	5	048011-23750	131	048011-26441	129	048011-29218	48
051144-21786	5	048011-23764	131	048011-26442	129	048011-29219	48
051144-21787	5	048011-23766	131	048011-26443	129	048011-29220	48
051144-21788	5	048011-23767	131	048011-26445	129	048011-29221	48
051144-21789	5	048011-23768	131	048011-26446	129	048011-29222	48
051144-21790	5	048011-23769	131	048011-26447	129	048011-29462	129
051144-21791	5	048011-23770	131	048011-26448	129	048011-29463	129
051144-21792	5	048011-23771	131	048011-26449	129	048011-29464	129
051144-21793	5	048011-23773	131	048011-26450	129	048011-29465	129
051144-21794	5	048011-23774	131	048011-26451	129	048011-29466	129
051144-21795	5	048011-23788	131	048011-26452	129	048011-29467	129
051144-21796	5	048011-23789	131	048011-26453	129	048011-29468	129
051144-21797	5	048011-23790	131	048011-26454	129	048011-29469	129
051144-21798	5	048011-23791	131	048011-26455	129	048011-29470	130
051144-21799	5	048011-23793	131	048011-26456	129	048011-29471	130
051144-21800	5	048011-23794	131	048011-26457	129	048011-29472	130
054007-22203	141	048011-23795	131	048011-26458	129	048011-29473	130
054007-22211	141	048011-23796	131	048011-26464	130	048011-29474	130
054007-22880	140, 141	048011-23798	131	048011-26465	130	048011-29476	130
040811-22970	39	054007-24035	141	048011-26466	130	048011-29477	130
040811-22971	39	054007-24043	141	048011-26467	130	048011-29566	129
040811-22972	39	256-02-00	117, 118, 119	048011-26468	130	021200-30023	98
054007-22997	140, 141	256-02-01	117, 118, 119	048011-26469	130	021200-30026	98
054007-23094	141	048011-25942	63, 67, 72	048011-26470	130	051128-30377	79
054007-23128	141	048011-25972	63, 67, 72	048011-26477	130	051128-30378	79
054007-23136	141	021200-26074	77	048011-26478	130	051128-30379	79
048011-23162	45	021200-26075	77	048011-26479	130	054007-34457	138
048011-23163	45	021200-26076	77	048011-26480	130	054007-34458	138
054007-23290	141	021200-26077	77	048011-26481	130	054007-34459	138
048011-23322	131	021200-26078	77	048011-26482	130	054007-34460	138
048011-23357	71	048011-26182	129	048011-26483	130	054007-34461	138
048011-23360	71	048011-26183	129	048011-27603	51	054007-34462	138
048011-23387	131	048011-26186	129	048011-27605	51	048011-34501	129
048011-23415	131	048011-26187	129	048011-27606	51	048011-34556	130
048011-23417	131	048011-26188	129	048011-27610	52	048011-34557	130
048011-23418	131	048011-26189	129	048011-27611	52	048011-34562	130
048011-23419	131	048011-26239	129	048011-27612	52	048011-34563	130
048011-23420	131	048011-26240	129	048011-27613	52	048011-34635	130
048011-23421	131	048011-26242	129	048011-27614	52	3500	114
048011-23430	131	048011-26243	129	048011-27615	52	3510	114
048011-23431	131	048011-26246	129	048011-27616	52	051131-35928	62
048011-23432	131	048011-26269	129	048011-27617	52	051131-35929	62
048011-23433	131	048011-26272	129	048011-27618	52	051135-36618	137
048011-23434	131	048011-26273	129	048011-27619	52	051135-36619	137
048011-23436	131	048011-26275	129	048011-27657	50	051135-36620	137
048011-23437	131	048011-26276	129	048011-27658	50	051135-36621	137
048011-23438	131	051131-26330	74	048011-27659	50	051135-36622	137
048011-23448	131	051131-26332	74	048011-27681	52	051135-36623	137
048011-23449	131	051131-26334	74	048011-27684	52	051135-36875	137
048011-23553	71	051131-26336	74	048011-27690	50	051135-36876	137
048011-23589	63, 67, 72	051131-26338	74	051135-27725	133	051135-36877	137
048011-23592	70	051131-26340	74	051135-27726	133	051135-36878	137
048011-23593	70	051131-26341	74	051135-27727	133	051135-36879	137
048011-23649	63, 67, 72	051131-26343	74	29026	120	051135-36880	137
048011-23650	63, 67, 72	051131-26344	74	048011-29211	48	051135-36881	137

Part Number Index

Part Number	Page	Part Number	Page	Part Number	Page	Part Number	Page
051135-36886	137	021200-45587	77	051111-50440	41	051111-55719	9
051135-36887	137	051131-46004	53	051111-50442	41	051111-55720	9
051135-36888	137	051131-46005	53	051111-50443	41	051111-55721	9
051135-36889	137	051131-46006	53	051111-50444	41	051111-55722	9
051135-36890	137	051131-46012	53	051111-50445	41	051111-55723	9
051135-36891	137	051131-46013	53	051111-50446	41	051144-55736	12
051135-36892	137	051131-46014	53	051111-50447	41	048011-56468	78
051135-36893	137	021200-48119	77	051111-50448	41	048011-56469	78
051135-36894	137	021200-49048	70	051111-50673	33	048011-56470	78
051131-37716	59, 69	021200-49110	99	051111-50675	33	051131-58709	81
051131-37717	59, 69	021200-49142	70	051111-50677	33	051131-58727	81
051131-37718	59, 69	021200-49143	70	051111-50679	33	051131-58728	81
051131-37720	70	021200-49144	70	054007-50727	135	051131-58729	81
051131-38116	62	021200-49158	100	051111-51045	41	051131-59094	78
051135-38444	137	054007-49517	136	051111-51046	41	021200-59129	69
021200-39296	70	054007-49518	136	051111-51047	39	021200-59151	145
021200-39523	83	054007-49519	136	051115-51065	22	021200-59152	145
021200-39524	83	054007-49571	135	051115-51066	22	5P71	115, 119
021200-41547	99	054007-49700	135	051111-51071	8	6001	115, 119
021200-41548	99	021200-50004	99	051111-51072	8	054007-60825	143
021200-41554	100	021200-50007	99	051144-51073	12	021200-61192	75
021200-41599	100	051131-50037	31	051111-51074	12	6191	108, 115
054007-42033	140	051131-50038	31	51P71	114	021200-62013	144
054007-42146	138	021200-50045	100	051131-52184	101	021200-62014	144
054007-42147	138	021200-50046	100	52P71	114	051131-62030	125
054007-42388	138	501	115, 119	055128-53042	81	021200-62225	144
054007-42389	138	051131-50197	17	048011-53299	78	021200-62334	76
054007-42390	138	051111-50203	30	055128-53460	81	021200-62335	76
054007-42391	138	051111-50204	30	048100-53464	77	6291	108, 115
021200-42425	76	051111-50205	30	048100-53465	77	6391	108, 115
021200-42426	76	051111-50206	27	048100-53466	77	051135-64666	21
021200-43181	81	051111-50207	27	048100-53467	77	6472	71
021200-43186	81	051111-50208	27	048100-53468	77	6473	71
021200-43793	100	051131-50253	78	048100-53469	77	051131-65141	101
021200-43797	100	051131-50254	78	048100-53470	77	051131-65142	101
021200-43798	100	051111-50409	36	051128-53593	142	051131-65289	125
021200-43799	100	051111-50410	36	051128-53594	142	051131-65601	101
021200-43813	100	051111-50411	36	051128-53595	142	051131-65988	101
021200-43814	100	051111-50412	36	051128-53596	142	051131-66206	101
051144-45091	48	051111-50413	36	051128-53597	142	051131-66207	101
051144-45095	48	051111-50414	36	051128-53598	142	051131-66209	101
051144-45096	48	051111-50415	36	051128-53599	142	051131-66427	125
051144-45101	51	051111-50416	36	051128-53600	142	6700	115, 116, 119
051144-45102	51	051111-50417	36	051128-53601	142	6700DIN	109
021200-45167	99	051111-50419	36	051128-53604	142	051131-67408	63, 67, 72
051144-45188	7	051111-50420	36	53P71	114	021200-67416	56
051144-45189	7	051111-50421	36	051111-54762	34	021200-67424	56
051144-45190	39	051111-50422	36	051111-54763	34	021200-67432	56
051144-45192	39	051111-50423	36	051111-54764	34	051131-67442	125
051144-45193	39	051111-50424	36	051111-54765	34	051138-67533	133
051144-45194	39	051111-50425	36	051111-54766	34	051138-67535	133
051144-45195	39	051111-50426	36	051111-54767	34	051138-67537	133
051144-45198	7	051111-50427	36	051111-54768	34	051138-67885	133
051144-45205	39	051111-50428	36	054007-55512	79	67P71	114, 115
051144-45206	39	051111-50429	36	051111-55713	9	6800	115, 116, 119
051144-45207	39	051111-50430	36	051111-55714	9	6800DIN	109
051144-45208	39	051111-50432	36	051111-55716	9	68P71	114, 115
051131-45217	27	051111-50433	36	051111-55717	9	6900	115, 116, 119
051131-45218	27	051111-50434	36	051111-55718	9	6900DIN	109

Part Number Index

Part Number	Page	Part Number	Page	Part Number	Page	Part Number	Page
69P71	114, 115	051131- 80974	101	021200- 85562	78	051144- 87470	66
051131- 70532	101	051131- 80988	77	021200- 85563	78	051144- 87471	66
051131- 70533	101	051144- 81368	37	021200- 85822	104	021200- 87998	98
051131- 70534	101	051144- 81470	65	021200- 86229	102	051131- 88418	134
051131- 70535	101	051144- 81471	65	021200- 86230	102	051131- 88619	133
051131- 70536	101	051144- 81728	39	021200- 86277	102	051131- 88622	133
7093	108, 110, 115	051144- 81729	39	021200- 86279	102	051131- 88624	133
7093B	108, 110, 115	051144- 81732	39	021200- 86289	102	051144- 88700	25
021200- 71450	144	051144- 81733	39	021200- 86309	102	051144- 88701	25
7220T	72	051144- 81734	39	021200- 86417	56	051144- 88702	25
7440	45	051144- 81735	39	021200- 86422	56	051144- 88703	25
7446	45	051144- 81736	37	021200- 86423	56	051144- 88704	25
7449T	72	051144- 81867	37	051144- 86468	4	051144- 88705	25
051128- 74779	79	051144- 81868	37	051144- 86469	4	051144- 88706	25
051128- 74780	79	8210	108	051144- 86470	4	051144- 88707	25
7501	110, 115, 119	8212	110	051144- 86471	4	051144- 88742	7
7502	110, 115, 119	8214	110	051144- 86472	4	051144- 88743	39
7503	110, 115, 119	051144- 82189	6	051144- 86473	4	051144- 88765	41
021200- 76394	70, 99	051144- 82238	40	051144- 86474	4	051144- 88769	41
021200- 76418	69	021200- 82242	98	051144- 86475	4	9021	72
021200- 76546	69	8242	71	051144- 86476	4	9021CS	72
021200- 76547	69	051131- 82562	17	051144- 86477	4	051131- 92040	78
051131- 76741	91	051131- 82659	30	051144- 86478	25	9210	108
051131- 77384	90	051131- 83260	78	051144- 86479	25	9211	108
051131- 77385	90	051144- 83497	17	051144- 86480	25	021200- 96309	99
051131- 77399	88	051144- 83678	3	051144- 86481	25	DSP-B	123
051131- 77400	88	051144- 83679	3	051144- 86482	25	GVP-1	116
051131- 77401	88	051144- 83680	3	051144- 86483	25	GVP-122	109, 116
051131- 77402	88	051144- 83681	3	051144- 86484	25	GVP-123	109, 111, 116
051131- 77403	88	021200- 83949	56	051144- 86485	25	GVP-401	116
051131- 77406	89	021200- 83950	56	051144- 86486	25	GVP-440	116
051131- 77407	89	051144- 83978	17	051144- 86487	25	GVP-441	116
051144- 77750	12	051144- 84229	7	051144- 86488	4	GVP-CB	116
051144- 77752	12	8440	71	051144- 86489	4	GVP-PSK/07190	116
051144- 77855	11	051141- 84701	79	051144- 86490	4	H-411	109, 116, 117
051144- 77856	30	051141- 84706	79	051144- 86491	4	H-412	116
7800S-L	111, 115, 116, 119	051141- 84802	79	051144- 86492	4	H-422	117
7800S-M	111, 115, 116, 119	051141- 84804	79	051144- 86493	4	H8750	126
7800S-S	111, 115, 116, 119	051141- 84806	79	051144- 86495	4	HP-100	120
051131- 79268	101	051141- 84901	79	051144- 86496	4	HP-156	120
051131- 79283	89	051141- 84904	79	051144- 86497	4	HP-157	120
051131- 79284	89	051141- 84905	79	021200- 86518	82	HP-255	120
051131- 79748	77	051141- 84906	79	021200- 86519	82	HP-256	120
051131- 79749	77	051141- 84911	79	021200- 86520	82	L-122	109, 111, 116, 118
051131- 79750	77	051131- 85076	34	021200- 86523	82	L-501	109, 116, 118
051131- 80052	90	051144- 85095	12	021200- 86524	82	L-503	111
051131- 80053	90	051131- 85097	34	021200- 86525	82	L-901	109
051131- 80054	90	051144- 85097	48	8654ES	126	L-905	111
051131- 80055	90	051131- 85098	34	8656ES	126	M-DC22DD	120
051131- 80056	90	051131- 85099	34	8660ES	126	M-FL550DD	120
051131- 80058	90	8511	108	8661ES	126	M-RG36300E	120
051144- 80512	38	8512	110	8662ES	126	M-RGC36100E	120
051144- 80513	38	8514	110	051131- 86848	78	M-RL15150DD	120
051144- 80514	39	8515	110	051131- 86849	78	M-RL38150DD	120
051144- 80515	39	051131- 85158	101	051131- 86850	78	P-FL550DD	120
051144- 80516	39	051131- 85159	101	051131- 86851	78	P-SKFL31	120
051144- 80517	39	8541	71	051131- 86852	78	P-SKFL5	120
		8550	71	051131- 86853	78	R1425ES	127
		021200- 85561	78	051131- 86862	78		

Part Number Index

Part Number	Page
R1427ES	127
R1611ES	127
R1620ES	127
R1621ES	127
R1631ES	128
R1700ES	128
R1701ES	128
R1710ES	128
R1712ES	128
R1720ES	128
R1721ES	128
R1911ES	128
R1912ES	128
R1921ES	128
R1922ES	128
R1931ES	128
R2071	127
R2091	127
R6022	115, 127
R6885ES	127
R7511ES	114, 115, 128
R7512ES	114, 115, 128
R7513ES	114, 115, 128
R7530ES	128
R8511ES	126
R8515ES	126
SA-2000	119
SA-2000LP	119
SA-2100	119
SA-2100LP	119
T-100	120
T-126	120
T-151	120
T-156	120
T-157	120
T-210	120
T-240	120
T-270	120
T-280	120
T-30	120
V-100	118
V-300	118
V-400	118
W-2806	117, 118, 119
W-2808	117, 118, 119
W-2862	117
W-2907	117
W-3018	117
W-3020-100	117, 118, 119
W-3020-25	117, 118, 119
W-3020-50	117, 118, 119
W-5114	117
W-9435-100	117, 118, 119
W-9435-25	117, 118, 119
W-9435-50	117, 118, 119

Argentina

Diego Meiriño
3M Argentina S.A.C.I.F.I.A.
Los Arboles 842 1686 - Hurlingham
Provincia de Buenos Aires
Phone: 54-1-662-6000
Fax: 54-1-665-4071

Australia

Steven Perez
3M Australia Pty., Ltd.
950 Pacific Highway
Pymble, N.S.W. 2073
Phone: 61-2-498-9333
Fax: 61-2-498-9666

Brazil

Waldyr Bevilacqua Jr.
3M DO Brasil Ltda.
Via Anhanguera, km 110
13177-070 - Sumare
Sao Paulo, Brasil
Phone: 55-192-864-7000
Fax: 55-192-864-1206

Canada

Andrew Spencer
3M Canada Company
300 Tartan Drive
London, Ontario, Canada N5V4M9
Phone: 519-452-6141
Fax: 519-659-5392
Toll Free 1-800-265-1840 ext. 6141

Caribbean Region

Jorge Aguilo
3M Puerto Rico, Inc.
P.R. Industrial Park
Ave. 65 Infanteria km. 12.6
Lote #6, 7
Carolina, Puerto Rico 00985
Phone: 787-750-3000
Fax: 787-750-3035

China Region

Henry M. Wong
3M China Limited
General Office
10/F, New Town Mansion
55 Loushanguan Road
Shanghai 200335 China
Phone: 86-21-6275-3535
Fax: 86-21-6275-2343

Colombia

Gustavo Sotelo
3M Columbia S.A.
Apartado Aereo 11091
Avenida El Dorado No. 78A93
Bogota, Colombia
Phone: 57-1-416-1666
Fax: 57-1-416-1677

Croatia

Tomislav Slat
Buzanova 2
10 000 Zagreb
Croatia
Phone: 00-385-12361502

Denmark

Svend Larson
Post Boks 1393
Fabriksparken 15
DK-2600 Glostrup
Denmark
Phone: 45-4348-2100

Europe

Mark Gates
3M House, P.O. Box 1
Market Place, Bracknell, Berkshire
RG12 1JU England
Phone: 44-1344-858000
Fax: 44-1344-858295

Finland

Jouni Seppanen
P.O. Box 90
02601 Espoo
Finland
Phone: 358-9-5252592

France

Pierre Mader
3M France, Boulevard de l'ÎOise
F-95006 Cergy-Pontoise Cedex
Phone: 33-1-30-31-6215
Fax: 33-1-30-31-7064

Germany

Werner Bibl
3M Germany
CarlSchurz-Strasse
D41453 Neuss
Germany
Phone: 49-209-590-8308

Greece

Panos Tsakos
3M Hellas, Ltd, 20 Kifissias Ave.
151 25 Paradissos.Maroussi - Athens
Phone: 30-1-6842-902
Fax: 30-1-6843-281

Gulf Region

Husam Abdelghani
Hamrain Centre
4th Floor
Alwahda Street
P.O. Box 20191
Dubai, UAE
Phone: 9661-4790555

Italy

Angelo Fossati
P.O. Box 10411-10412
Via s.Bovio, 3
20090 Loc S.Felice Di
Segrate
Milan
Phone: 3902-7035-2286

Japan

H. Hasebe (Sumitomo)
33-1, Tamagawadai 2-chome
Setagaya-ku, Tokoyo 158 Japan
Phone: 81-3-3709-8111
Fax: 81-3-3709-8746

Korea

C. S. Eo
11th Floor Life Building
#61, Yoldo-dong, Yondungpo-Ku
Seoul 150-010, Korea
Phone: 82-2-3771-4114
Fax: 82-2-785-2923

Mexico

Ariel Correa Gomez
3M Mexico/Riker S.A. de C.V.
Calz, San Juan De Aragon 516
Col. Carrera Lardizabel
Del. Gustavo A. Madero
Mexico, D.F. 07070 Mexico
Phone: 52-5-626-0400
Fax: 52-5-728-2299

Netherlands

Arnold Kroon
Industrieweg 24
2382 NW Zoeterwoude
P.O. Box 193
2300 AD Leiden
The Netherlands
Phone: 3131-854-3094

New Zealand

Chris Brereton
3M New Zealand Ltd.
250 Archers Road
Glenfield, Auckland, New Zealand
Phone: 64-9-444-4760
Fax: 64-9-444-2773

Norway

Lars Halvorsen
P.O. Box 100
N-2013 Skjetten
Norway
Phone: 47-6384-2500

Singapore

Bee Khoon Ng
3M Singapore
9, Tagore Lane Singapore 2678
Republic of Singapore
Phone: 65-45-48611
Fax: 65-45-85432

South Africa

Kenneth Chiochetti
3M South Africa
3M South Africa (Pty.) Ltd
181 Barbara Road
Elandsfontein, 1406
Republic of South Africa
Phone: 27-11-922-9111
Fax: 27-11-922-2271

Spain

Francisco Mercader
3M Espana CA
Calle Juan Ignaci
Luca de Tena 19-25
28027 Madrid
Spain
Phone: 34-91-321-6217

Sweden

Christina N. Anderssen
Bollstanavsgen 3
SE 191.89 Sollentuna
Saffans Vag 4
Sweden
Phone: 46-8-92-2222

Taiwan

Rosa Wen
3M Taiwan Limited
13th Floor, Lotus Building
136 Sec 3, Jen Ai Rd.
Taipei 10628, Taiwan, R.O.C.
Phone: 886-2-704-9011
Fax: 886-2-706-0383

Trinidad & Tobago

Glenda de Silva
3M InterAmerica, Inc.
P.O. Box 1296, Port of Spain
Trinidad WI
Phone: 809-623-8917
Fax: 809-623-3079

Turkey

Selim Birsan
Nisbetiye Cad.Akmerkez
Blik 3 Kat: 6 Etiler
80600 Istanbul
Turkey
Phone: 90-212-282-2382

United Kingdom/Ireland

Peter Furby & Colin Ridout
3M United Kingdom plc
3M House, P.O. Box 1
Market Place, Bracknell, Berkshire
RG12 1JU England
Phone: 44-1344-858000
Fax: 44-1344-858295

Venezuela

Miguel Fuentes
3M Manufacturera Venezuela S.A.
Puente Brion a Luis Razetti
Edif, 3M
La Candelaria, Caracas 1010-A
Phone: 58-2-508-8111
Fax: 58-2-5740910

All Other International Inquiries

3M Marine & Specialty Vehicle
Market Center
3M Center - Bldg. 223-1N-13
St. Paul, MN 55144-1000 U.S.A.
Phone: 651-733-1110
Fax: 651-737-9658



3M Branch Offices



Alaska
11151 Calaska Circle
Anchorage, AK 99515
Telephone: (907) 522-5200
Fax: (907) 522-1645

Atlanta
2860 Bankers Industrial Drive
Atlanta, GA 30360
Telephone 1-800-771-7049
Fax 1-800-699-7840

Hawaii
4443 Malaai Circle
Mail to: P.O. Box 30048
Honolulu, HI 96818
Telephone: (808) 422-2721
Fax: (808) 422-9557

For Further Information
1-877-3M-Marine
(1-877-366-2746)

Internet
www.3M.com/marine



Marine

3M Center, Building 223-1N-13
St. Paul, MN 55144-1000

Please Recycle

